

Lincat

FOODSERVICE SOLUTIONS | 2023

PRICE LIST

4 Global Brands



Your complete foodservice solution from one supplier.



Lincat

Page L1

- Prime Cooking Equipment
- Water Boilers
- Holding and Servery



frifri

Page F1

- Fryers
- Pasta Cookers
- Chip Scuttles



imc

fresh thinking

Page i1

- Bar Systems
- Vegetable Preparation
- Waste Management
- Cleaning and Rinsing



Britannia

Kitchen ventilation

Page B1

- Ventilation
- Recirculation

Lincat

lincat.co.uk



2 YEAR UK parts and labour warranty Export parts warranty on all products*

*excluding mobile hand wash stations supplied with 1 year warranty

UK Tel: 01522 875500 Export Tel: +44 1522 503250 UK e-mail: sales@lincat.co.uk Export e-mail: export@lincat.co.uk

Lincat Limited, Whisby Road, Lincoln. LN6 3QZ. United Kingdom.

Group member of **MIDDLEBY**

All prices are exclusive of VAT.

UK - Goods are normally delivered free of charge to either the dealers' address or direct within 3 working days. If overnight and/or premium services are required charges will apply.

Export - Goods are priced ex works, export crates POA.

Any units which are built to order or include factory fit options are non-returnable.

2023

Introducing the new

Lincat

GREEN RANGE



SHAPING THE FUTURE

In response to increasing customer interest in the sustainable solutions we offer, we have brought together products in our portfolio which use less

oil, offer energy and/or labour savings, reduce food waste, faster cooking, increased food yield and/or transport savings.



Less oil usage



Less energy usage



Labour saving



Less food waste



Speedier cooking



Increased food yield



Less water waste



Less detergent waste



Transport saving

Lincat

GREEN RANGE

Contents



Induction Oven Ranges : **G3**



Induction Hobs : **G4/5**



Electric Fryers : **G6/7**



Gas Fryer : **G8**



Salamanders : **G9/10**



Clam Griddles : **G11**



Chargrills : **G12/13**



Fast Ovens : **G14**



High Speed Ovens : **G15**



Hot Holding Bins : **G16**



Hot Air Merchandisers : **G17**



Water Boilers : **G18**



Food Waste Management : **G19**



Dry Waste Compactors : **G20**

2
YEAR

UK parts and labour warranty

Export parts warranty

on all Lincat products

Induction Oven Ranges

Delivering across the range



Reduced energy usage



Labour saving



OE8017

4x 5.3kW 270mm induction zones

PHER01

6x 1.85kW ZONES
Can be boosted to 3kW

PHER02

4x 1.85kW ZONES
Can be boosted to 3kW

Opus 800



DELIVER
90%
EFFICIENCY

compared to 55% with a solid electric hot plate and 50% with a gas hob

AUTOMATIC
PAN
DETECTION

function cuts power when no pan is present, preventing harm to users, while **saving energy**

MULTIPLE INTERNAL
COOLING
FANS

and overheat protection for **long service life**

VENTILATION AND AIR CONDITIONING
COSTS

can also be reduced, as the heat is generated in the pan instead of the hob surface, **focusing energy** where it's needed and **not wasting** it into the kitchen.

EASY TO
CLEAN
& **HYGIENIC**

with high impact resistant ceramic glass surfaces. It's tough too!

Induction Hobs

2x 5.3kW ZONES

OE8013



4x 5.3kW ZONES

OE8014



Suites with Opus 800 Series

2x 5.3kW ZONES

OE8018



4x 5.3kW ZONES

OE8019



Opus 800

2x 3kW ZONES

PHEH01



DELIVER
90%
EFFICIENCY

compared to 55% with a solid electric hot plate and 50% with a gas hob

AUTOMATIC
PAN
DETECTION

function cuts power when no pan is present, preventing harm to users, while **saving energy**

MULTIPLE INTERNAL
COOLING
FANS

and overheat protection for long service life

Delivering across the range



1x 3kW ZONE

SLI3



1x 2.4kW ZONE

SLI3W



2x 3kW ZONES

SLI21



4x 3kW ZONES

SLI42



SILVERLINK 600



1x 5.3kW ZONES

IH3



2x 5.3kW ZONES

IH42



4x 5.3kW ZONES

IH21



Lincat Specialist

VENTILATION AND AIR CONDITIONING COSTS

can also be reduced, as the heat is generated in the pan instead of the hob surface, **focusing energy** where it's needed and **not wasting** it into the kitchen.

EASY TO CLEAN & HYGIENIC

with high impact resistant ceramic glass surfaces. It's tough too!

Electric Fryers

Delivering across the range

Reduced energy usage

Labour saving

Reduced oil usage

Reduced food waste



Thermal insulation reduces heat loss to less than 0.4 °C/minute



frifri Touch

OIL ASSISTANT FOR EXTENDED OIL LIFE

REDUCE FOOD WASTE

Adaptive cooking, never undercook food again

TWO STAGE FILTRATION EXTENDS OIL LIFE BY UP TO **75%**

ELECTRONIC TEMPERATURE CONTROL FOR EXTENDED OIL LIFE & ENERGY SAVING

UNIQUE ELEMENTS FOR EXTENDED OIL & ELEMENT LIFE

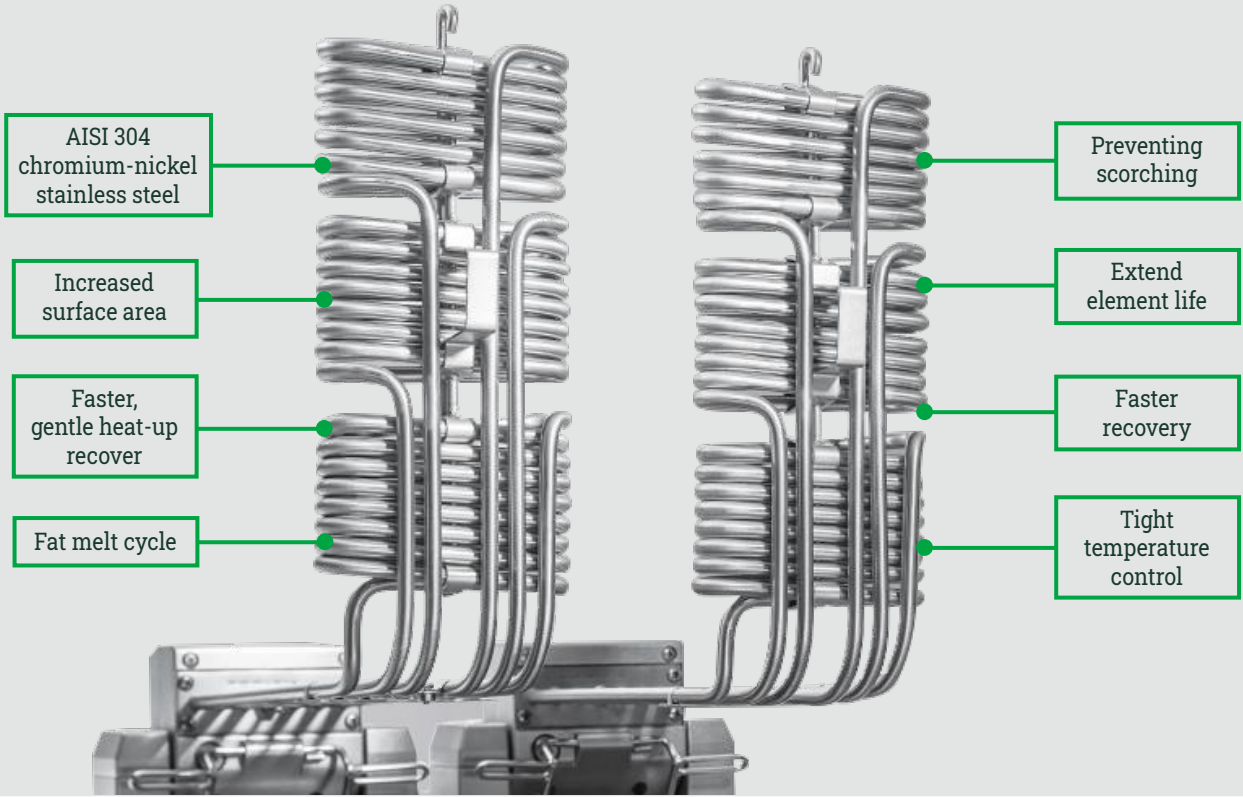

Data Management

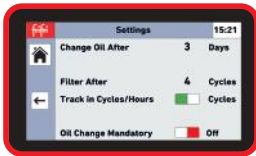

Oil Management



Oil Assistant

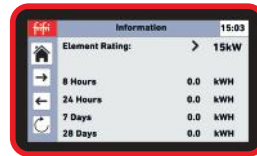

Energy Management

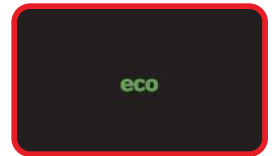

eco mode

xFRI[®] PUMPED FILTRATION
FOR EASE & SAFETY

ECO MODE FOR
ENERGY SAVINGS,
 EXTENDED OIL & ELEMENT LIFE

OIL MANAGEMENT FOR
 EXTENDED
OIL LIFE

REDUCE FOOD WASTE
LIFTFRI[®]
 AUTOMATIC BASKET LIFT OPTION
 never undercook food again

COOK JUST
 WHAT YOU NEED -
TWIN & TRIPLE TANKS

MAKE INFORMED BUSINESS DECISIONS
WITH DATA MANAGEMENT

Gas Fryer

Delivering across the range



Reduced energy usage



Labour saving



Reduced oil usage



OG8115

Safer oil drainage through the body of the fryer

Convenient electronic ignition



Opus 800

TWO STAGE FILTRATION
EXTENDS OIL LIFE BY UP TO 75%

DELIVER **97% ENERGY EFFICIENCY**
Independent BSI test

SAFER. REDUCE RISK OF **HOT OIL** SPILLAGE OR ACCIDENTS
with pumped filtration as standard

RESIDUAL **HEAT RECOVERY SYSTEM**
maximising energy efficiency

MAXIMISE **OIL LIFE.** FILTER OIL **DURING OR AFTER SERVICE**
Be ready to go in 5 mins

EASY TO **CLEAN** EASY ACCESS **TANKS**

SAFER. OIL DRAINAGE THROUGH THE BODY OF THE **FRYER**

Cook & Hold Salamander

Delivering across the range



Reduced energy usage



Speedier cooking



Reduced food waste



Opus 800



FAST
HEAT UP.
READY TO
COOK IN
8 SECONDS

ENERGY SAVING
PLATE DETECTION



REDUCE **FOOD WASTE.**



Hold function keeps food warm but does not continue to cook

3 COOK ZONES



Only turn on the area you need

REDUCE **HEAT LOSS**



Self-balancing height adjustable grill hood

Adjustable Salamander

Delivering across the range

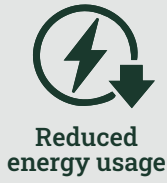

Reduced energy usage



Speedier cooking

GNI/1 compatible



PHEAS01

15 minute timer



 **FAST**
HEAT UP.
READY TO
COOK IN
8 SECONDS

REDUCE
HEAT LOSS 
Self-balancing
height adjustable
grill hood

 **3**
COOK
ZONES
Only turn on the
area you need

Clam Griddles

Delivering across the range



Reduced energy usage



Labour saving



Speedier cooking



Reduced food waste



Increased food yield



400mm wide and 800mm wide models



Available with smooth and or ribbed plates for attractive branding presentation marks

Quick and easy to clean with removable Teflon sheets

Opus 800

COOKS 3
UP TO **x3**
QUICKER

Than a standard griddle

2
COOK
ZONES

Only turn on the area you need (OE8210)

REDUCE **FOOD WASTE.**



Digital timer on each plate for repeatable results

INCREASE **YIELD**
LESS **SHRINKAGE**

Gas Chargrill

Delivering across the range



Reduced energy usage



Labour saving



Opus 800

 **FAST**
HEAT UP.
POWERFUL
RED CERAMIC
PLAQUE BURNERS

 **3/5/7**
COOK
ZONES

Only turn on the area you need

EASIER TO
CLEAN.
SELF-CLEANING
CAST IRON
BRANDING GRIDS 

SAVE UP TO
£900
IN GAS
PER YEAR 
(900mm)

Synergy Grill

Delivering across the range



Reduced energy usage



Labour saving



Speedier cooking



Increased food yield



Opus 800

USES
59%
LESS GAS

EASY TO CLEAN.
FAT IS
ATOMISED

Any residual dust can be vacuumed

INCREASE
YIELD
LESS
SHRINKAGE

25%
LESS
EXTRACTION

Reduced strain on ventilation systems

HIGH
HEAT
FOR FASTER
COOKING

Fast Oven

Delivering across the range



Reduced energy usage



Labour saving



Speedier cooking



Reduced food waste

Re-circulates the hot cooking air through a heater and catalytic convertor before its blown back into the cooking chamber



CIBO/B



CIBO/C

Direct cook on base, no need to warm a baking tray



CIBO/M



CIBO/S



CIBO/T



REDUCE 
FOOD WASTE. 

Cook on demand

VENTLESS COOKING USES LESS 

energy over traditional hood systems

FAST COOKING
 **SAVE ENERGY**
AND INCREASE **STAFF EFFICIENCY**

 **98% RECYCLABLE COMPONENTS**

High Speed Oven

Delivering across the range



Reduced energy usage



Labour saving



Speedier cooking



Reduced food waste

Direct cook on base, no need to warm a baking tray



CIBOPLUS/R



CIBOPLUS/G



 **25% FASTER HEAT UP**

 **12x FASTER COOKING**

VENTLESS COOKING USES LESS 
energy over traditional hood systems

 **ECO MODE USES LESS THAN 1kW PER HOUR**

FASTER CLEANING. RAPID COOLDOWN+ 

REDUCE FOOD WASTE. 
Cook on demand

 **98% RECYCLABLE COMPONENTS**

Hot Holding Bin

Delivering across the range



Reduced energy usage



Labour saving



Reduced food waste



Use with 2 x 1/1GN, 4 x 2/4GN or a combination of these

HHB12100

Intuitive digital controls



PANTHER

REDUCE  **FOOD WASTE.** 

Hold for up to 1 hour in perfect serving condition

 **2 ZONES**

Only turn on the area you need

 **SPEED UP SERVICE - EASY ACCESS DESIGN**

 **MAXIMISE EFFICIENCY** PREPARE AHEAD OF **BUSY PERIODS**

Hot Air Merchandisers

Delivering across the range



Reduced energy usage



Labour saving



Reduced food waste



HAD40

Compact 400mm and 500mm wide design

HAD50

Ideal for all sorts of pre-cooked foods including pies, pizzas and sausage rolls



SEAL

GRAB & GO!

REDUCE **FOOD WASTE.**



Hold for up to 4 hours in perfect serving condition

MAXIMISE EFFICIENCY
PREPARE AHEAD OF
BUSY PERIODS

MAXIMISE **ENERGY EFFICIENCY**

Hot Air curtain minimises heat loss

Water Boilers

Delivering across the range



Reduced energy usage



Labour saving

Intuitive digital controls



 **MAXIMISE
STAFF
EFFICIENCY**

No more waiting for the kettle to boil

ECO 
MODE

Reduce the volume of boiling water **by 50%** for quieter periods

 **ENERGY
SAVING**
7 DAY TIMER

Switch off overnight or at weekends

**ECONOMICAL
INTELLIGENT
PREDICTIVE
ECO** 
SETTING

Learns usage patterns and switches between eco and standard mode to deliver required output

Food Waste Management

Delivering across the range



Reduced energy usage



Labour saving



Transport saving

Onward processes include in-vessel composting, anaerobic digestion or production of compressed pellets for biofuels

High capture rates improve the quality of the grey water going to drain

WasteStation

WasteStation Compact



WASTE STATION

80%
REDUCTION
IN WASTE
VOLUME

60%
REDUCTION
IN WASTE
MASS

LABOUR
SAVING.
REDUCE STAFF
TIME
MANAGING WASTE

ENERGY
SAVING
SHORT PROCESSING
TIME

REDUCE
WASTE.
SENT
TO LANDFILL

EASY
CLEAN.
SELF
CLEANING CYCLE

Ensures system is free from food

Dry Waste Compactors

Delivering across the range



Reduced energy usage



Labour saving



Transport saving

Compresses all dry waste, including cardboard, tins, plastic and paper

F56/500



F56/700



Compact easy to move unit can be conveniently located where waste is produced



80%
REDUCTION
IN WASTE
VOLUME

REDUCE
WASTE.
SENT
TO LANDFILL



LABOUR
SAVING.
REDUCE STAFF
TIME
MANAGING WASTE

Lincat

PRODUCT RANGE & PRICE LIST



SPECIALISING IN

- PRIME COOKING EQUIPMENT
- WATER BOILERS
- HOLDING & SERVERY

Contents



CIBO

Do you love to serve great quality food? Us too!

Award winning high speed cooking at its best. Produce a wide range of perfectly-cooked food in less than three minutes

Ideally suited for:

A wide variety of cafés, bars, restaurants and quick-serve outlets, as well as event and mobile catering.

Why choose CIBO?

- Cook, toast and reheat, fresh and frozen foods
- Space-saving and compact
- Plug and play - on a 3-pin 3kW UK plug

- Ventless cooking - catalyst technology
- Clear icons and an easy-to-use touchscreen
- Replace your panini grill, toaster, convection oven and grill

Find out more on page

L5



Opus 800

Powerful cooking all day long

Heavy Duty Prime Cooking Equipment

Ideally suited for:

Busy restaurants, chain restaurants and high-volume kitchens, that barely stop from breakfast right on through to closing time.

Why choose Opus 800?

- 800mm deep
- Enhanced performance, energy efficiency and serviceability

- Strong and durable
- Increased capacity
- Gas and electric versions available
- Easy to clean

Find out more on page

L19



CONVECTOR

Putting you in control for perfect results every time

Convection Ovens

Ideally suited for:

Busy restaurants, bakeries and high-volume kitchens.

Why choose Convector?

- Uniform results, every time, even when full
- Roast, braise, bake and reheat
- Strong and durable

- Two-speed bi-directional fan
- Oven cavity optimised for airflow
- Manual+ and Touch models available
- Intuitive easy to use controls

Find out more on page

L35



blu

KEEPING IT COOL

Refrigerated storage and easy access of food at point of cooking

Fridges, Freezers & Blast Chillers

Ideally suited for:

Busy restaurants, chain restaurants and high-volume kitchens.

Why choose blu?

- Holds food at the optimum temperature

- Increased efficiency, storing food at point of cooking

Find out more on page

L41



PHOENIX

Powerful performance at a low price point

Medium Duty Cooking Equipment

Ideally suited for:

Medium sized pubs and restaurants, schools and care homes.

Why choose Phoenix?

- Ideal for cost conscious who don't want to sacrifice quality, power and performance
- Will handle day to day demands of the busiest of kitchens

- Robust and durable
- Gas and electric versions available
- Easy to clean

Find out more on page

L43



SILVERLINK 600

Configure your cooking with modular flexibility

Modular Cooking Equipment

Ideally suited for:

Care homes, cafe bars and small to medium pubs and restaurants, serving on a shift basis (lunch and dinner).

Why choose Silverlink 600?

- 600mm deep
- Modular kitchen equipment that will allow you to build a custom appearance for your kitchen

- Free standing and counter top units can be sited on a range of ovens, pedestals and stands
- Gas and electric versions available
- Easy to clean

Find out more on page

L47



LYNX400
High quality plug in
and play cooking
**Compact Counter Top
Cooking Equipment**

Ideally suited for:

Pubs, cafe bars and
event catering.

Why choose Lynx 400?

- Plug and play, no
installation necessary
- Simple, reliable
operation
- Compact and
portable
- Electric cooking
equipment
- Built in the UK
to the highest
quality
- 2 years on site
parts and labour
warranty

Find out
more on
page

L57



Lincat Specialist
'Built for purpose' cooking
equipment
**Convection Ovens, Pizza Ovens,
Food Warming Drawers,
Induction Hobs, Fume Filtration,
Ventilation Systems**

Ideally suited for:

Specialist applications.

Why choose Lincat?

- Series is 'built
for purpose' and
supports menu
offering
- Wide range
of specialist
products
- Guaranteed
quality

Find out
more on
page

L63



PANTHER
Ensuring that perfect
dishes stay perfect
**Static and Mobile
Hot Cupboards**

Ideally suited for:

Care homes,
restaurants
and schools.

Why choose Panther?

- 670 and 800 series
are available in
various lengths
- Robust and flexible
hot cupboards can
transport food as
well as being used
as a servery or
kitchen pass

- Fully configurable to
meet your needs

Find out
more on
page

L69



Filterflow
Quality hot water on tap 24/7
**Auto and Manual Fill
water boilers**

Ideally suited for:

Offices and staff
rooms, cafe bars and
anywhere else where
you need high volumes
of boiling water.

**Why choose
Filterflow?**

- High quality boiling
water on tap 24/7

- Ensures that tea
breaks no longer have
to include waiting
around
- Built in filtration
system with a high
volume, easy
change FilterFlow
cartridge
- High output from
narrow footprint

- Easy to use and
cheap to run

- Enhanced
diagnostics

- Connected to the
mains and water
supply

Find out
more on
page

L75



SEAL
Showcase your food
and increase sales
**Heated, Refrigerated
and Ambient
Merchandisers**

Ideally suited for:

School and college
canteens, hotels and
cafes.

Why choose Seal?

- Ambient, refrigerated
and heated range of
merchandisers and
displays
- Option of back
service or self
service operation

- Offer a reliable
method for keeping
food in the optimum
condition before
service

- The sleek and
elegant designs
show off your food
at its best to
tempt customers.

Find out
more on
page

L83



DESIGNED FOR YOUR FUTURE

- Faster service - food ordered now, served now
 - Fantastic food, every time
 - A wider menu choice
 - Reduced queues
 - Increased productivity
 - Less waste
-
- Happy, loyal customers
 - Maximised profits
 - A future proofed business



DESIGNED TO SUPPORT YOU AND GET YOU COOKING FAST

Every CiBO+ oven is supplied with a recipe book with over 100 recipes from hot snacks, pizzas, pastries, sweet foods, appetisers, main dishes, side dishes and breakfast dishes

DESIGNED TO HELP YOU ACHIEVE

If you have any questions about achieving the best results our chef team are prepped and ready to take your call on

01522 875581



Scan me to view the CiBO+ Recipe book, containing 100+ recipes!





AWARD WINNING
HIGH SPEED COOKING
AT ITS BEST



Supplier of the Year for New Product Development - Chef Solutions





Launched in April 2022, the award winning CiBO+ is unlike any other high speed oven on the market.

Utilising a unique, patent pending **tri-heat technology**, **Microwave**, **TurboAir** and **ContactBase** combine to deliver unrivalled speed, quality and consistency - cooking in seconds, not minutes.

CiBO+ is a flexible oven designed to cook a wide variety of menu items including hot snacks, pizza, pastries, sweet food, appetisers, main dishes, side dishes and breakfast dishes.



Today distributed to over 40 countries, the original award winning CiBO is one of our most popular products.

The original **CiBO delivers** fantastic tasting food, quickly at a great price point, to all size of foodservice operation large and small.

Using a patented combination of three different heat sources – **convection**, **grill** and a **heated base**, the entry level original **CiBO** oven is great for thinner products such as pizza. Paninis, baguettes, toasties should be cooked open, as two halves and then assembled.

With an absence of microwave technology, the original **CiBO** is not recommended for frozen and denser foods such as lasagne, chicken wings and jacket potatoes.



SETTING THE NEW BENCHMARK IN HIGH SPEED VENTLESS COOKING

Why choose CiBO+?

- Designed in **COLLABORATION** with industry professionals
- Improves the food **QUALITY** of high-speed cooking
- Designed to be **SIMPLE** and **EASY** to operate
- Ultimate **VERSATILITY**, cook a huge variety of dishes!
- For use **FRONT** and **BACK** of house
- The **AFFORDABLE** all-round cooking assistant
- The industry has voted, three independent awards **WON!**



Supplier of the Year for New Product Development - Chef Solutions

2 YEAR
UK Parts and labour warranty

Export Parts Only

ACCELERATED COOKING AT ITS BEST!



DESIGNED FOR PREMIUM RESULTS



DESIGNED TO RAPIDLY COOK, TOAST, GRILL AND REHEAT IN ONE COMPACT UNIT

Tri-heat technology using Microwave, TurboAir and ContactBase delivers unrivalled speed, quality and consistency - cooking in seconds, not minutes.

Typically when microwaves are used in high speed ovens they can cause the product to 'sweat', however the combination of unique TurboAir and ContactBase in CiBO+ overcomes this and ensures even colouration and crisp results. Our technology ensures quality is not compromised for speed. We wanted both in our design.

DESIGNED FOR SPEED

A rear launched Microwave with stirrer brings speed to the cooking process.



DESIGNED FOR COLOURATION

TurboAir distributes high speed airflow in a cylindrical patten over the food with a speed of 4 metres per second!



DESIGNED FOR CRISPINESS

Adjustable temperature control, rapid heat up and direct cooking on the toughened neo ceram ContactBase delivers perfect base colouration and crispiness - there is no soggy bottoms with CiBO+.





DESIGNED FOR QUALITY

WHY COMPROMISE QUALITY COOKING EVERYTHING AT THE SAME TEMPERATURE?

Users can set up to five different oven and base temperatures and then menu items can be assigned to a group which will deliver the best results.

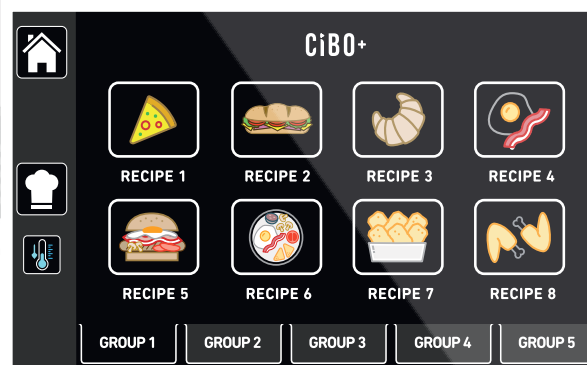

 QPad

DESIGNED WITHOUT LIMITS

Ventless, compact and plugging into a standard 13amp socket, **CiBO+** is designed to be used in non-traditional spaces such as garage forecourts, convenience stores, back counters in leisure centres etc. and with this brings the challenge of multiple operators with potentially limited food skills.

With **CiBO+** achieve the same high quality result for every order. Simply press any one of the 40 menu items on the **QPad** touch screen and the oven will do the rest. Removing language barriers, minimising training time, operating errors and food waste.

Designed to deliver big in small spaces, the 395mm x 600mm compact footprint has a generous sized oven easily accommodating a 12" pizza!





DESIGNED FOR PERSONALISATION

It is easy to customise the position of menu items on the screen and optimise recipe settings to suit the needs of the business with the **Touch & Change concept technology**. Simply touch what needs to be changed, and change it. The PIN lock can be utilised to protect recipe settings, for the same great results every time regardless of the operator. For chains and multi-site operations, menus can be cloned and shared between sites via USB.

Available in four colours – black, purple, green and red. Support dietary preferences with a green oven for vegan and red for proteins, alternatively business owners can choose the colour to suit their business.



DESIGNED TO BE KINDER TO THE PLANET

(AND BOTTOM LINE)

25% faster heat up, rapid **Cooldown+**, plus cooking 12x faster than conventional cooking methods, saves energy and time, as well as increasing staff productivity. And the savings don't stop there! Designed to be efficient in the use of the energy during the cooking process **CiBO+** will deliver 3 x 12" pizzas and 6 toasties using just 1.44kW of energy!

The ventless technology also deliver energy savings re-circulating the hot cooking air through a heater and catalytic converter before its blown back into the cooking chamber.

And when the oven isn't in use, in eco model it uses less than 1kW per hour!

GREEN +





DESIGNED TO LOOK AFTER YOU

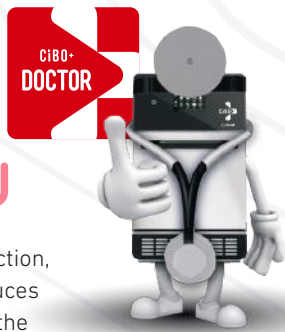

At a time when everyone is sensitive to cross infection, **unique antimicrobial protection** technology reduces the spread of viruses on touch points including the touch screen and door handle.

In the event of an issue, **CiBO+ Doctor** is designed to alert you to and identify the fault in advance of engineer attendance, increasing the likelihood of a first time fix.

DESIGNED FOR SPEEDY CLEANING

The unique rapid **Cooldown+** programme cools the oven in minutes without the need for an ice tray.

CiBO+ Sparkle Cleaner, CiBO+ Protect Shield and a smooth, easy to clean cavity speed up the cleaning process.

Designed for easy access, the front mounted air filter can be easily removed and put through the dishwasher.

CLEAN + ✨



DESIGNED FOR THE FUTURE

For peace of mind, CiBO+ has been designed to be future proofed, with USB for updates, configuring and cloning menu sharing.

DESIGNED FOR PEACE OF MIND

Manufactured in the UK and supplied with a comprehensive, two year parts and onsite labour warranty





DESIGNED TO DELIVER FOR YOU



FOOD TO GO!

- REFUEL** your customers, food ordered now, ready now!
- CREATE** tasty sandwiches, wraps and baked goods without a chef.
- SECURE** loyal returning customers with great tasting, quick snacks for people on the go.



COFFEE SHOPS

- FLEXIBLE**, create food all day long – for breakfast, brunch, lunch and dinner!
- SPEED**, food ordered now, ready now, reducing queues.
- DELICIOUS**, bring inspiration to your menu without the need for a chef.

What could you deliver?

What could you deliver?

BACON Roll
 12 MONTH PROFIT OPPORTUNITY
£24,570
 COOKS IN 45 SECS.



CROISSANTS
 12 MONTH PROFIT OPPORTUNITY
£13,741
 COOKS IN 20 SECS.



Vegan PIZZA
 12 MONTH PROFIT OPPORTUNITY
£56,875
 COOKS IN 1 MIN. 35 SECS.



Paninis
 12 MONTH PROFIT OPPORTUNITY
£22,841
 COOKS IN 45 SECS.





Scan me to view the CiBO+ Recipe book, containing 100+ recipes!



RESTAURANTS

DELIVER in the face of staff shortages and a small kitchen.

MIX UP your menu to stop things getting boring!

IMPRESS, stand out from the competition and keep customers coming back for more!



EDUCATION

ENERGISE and fuel the mind with tasty snacks, without the need for a chef.

GROW your menu offering (and profit) within a 395mm footprint.

INSPIRE with quality, repeatable results, time after time.

What could you deliver?



RIBS & Fries

12 MONTH PROFIT OPPORTUNITY

£104,104

COOKS IN 1 MIN. 20 SECS.

What could you deliver?

Wraps

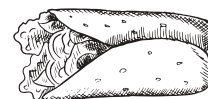

12 MONTH PROFIT OPPORTUNITY

£8,385

COOKS IN 50 SECS.

12 MONTH PROFIT OPPORTUNITY

£46,046

COOKS IN 2 MIN.

CHICKEN WINGS & Fries



WAFFLES

12 MONTH PROFIT OPPORTUNITY

£6,240

COOKS IN 30 SECS.

All figures are based on 25 servings per day.



High Speed Ovens



CiBO+ high speed ovens							
MODEL	PRICE £	PRICE €	H	W	D	POWER	WT
CIBOPLUS/B	£6987	€8036	640	395	728	3 kW	65
CIBOPLUS/R	£6987	€8036	640	395	728	3 kW	65
CIBOPLUS/G	£6987	€8036	640	395	728	3 kW	65
CIBOPLUS/P	£6987	€8036	640	395	728	3 kW	65
Internal usable dimensions			195	340	340		

	MODEL	PRICE £	PRICE €	DESCRIPTION
A	LT02	£65	€75	Paddle with handguard and sides
C	CIBO/TT	£74	€86	Non-stick Teflon Tray
C	TFS05	£12	€14	Non-stick Teflon Sheets
A	NSBT23	£118	€136	Non-stick Baking Tray
A	CIBO/ET	£20.40	€23.50	Multi-tray
A	SH136	£19.80	€22.80	Wire Rack
A	SK05	£1289	€1483	Moveable Stacking Stand, with front lock castors
A	LTH01	£65	€75	Magnetic Paddle Holder
C	OC01	£26.55	€30.55	CiBO+ Sparkle Oven Cleaner
C	OS01	£49	€56.35	CiBO+ Protect Oven Shield

In the box



Paddle with handguard and sides **LT02**



CiBO+ Sparkle Oven Cleaner **OC01**
CiBO+ Protect Oven Shield **OS01**



Non-stick Teflon Tray **CIBO/TT**



Non-stick Teflon Sheets **TFS05**

Other accessories available



Non-stick Baking Tray **NSBT23**



Moveable Stacking Stand, with front lock castors **SK05**



Wire Rack **SH136**

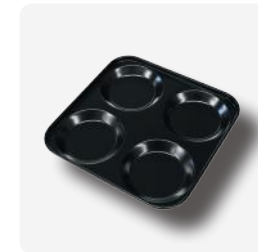

Multi-tray **CIBO/ET**



Magnetic Paddle Hanger **LTH01**

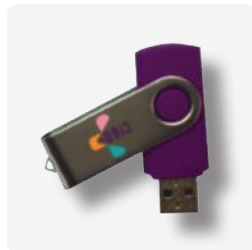

USB Stick **CIBOPLUS/US**

2 YEAR UK parts and labour warranty | Export parts warranty
on all Lincat products

CiBO



Do you love to serve your customers great quality food? Us too!

CiBO is an innovative new fast oven, which can produce a wide range of perfectly-cooked food in less than three minutes.

Able to cook, toast and reheat multiple fresh and frozen foods, CiBO's versatility provides a full cooking platform for outlets, enabling you to create and expand menus, deliver food of a consistent high quality and maximise profit.

Ideally suited for...

Suitable for a wide variety of cafés, bars, restaurants and quick-serve outlets, as well as event and mobile catering.



Café & Bar

High-quality snacks and smaller items, such as toasted sandwiches, paninis, pizzas and baked goods, can be delivered with speed throughout the day.



Convenience & Quick Serve

A wide range of snacks and baked goods can be made quickly and easily, with a single space-saving single appliance. Clear icons and an easy-to-use touchscreen can be operated by any staff, regardless of training and skills.



Event & Mobile Catering

Carry out event and mobile catering with ease, compact, ventless and operating from a 13-amp plug – you simply plug in and play.



Restaurant & Hotel

Chefs can broaden their food offering and develop creative, customised menus that deliver consistent quality with CiBO. Ease-of-use also makes CiBO perfect for hotels, especially when it comes to out-of-hours room service.

CiBO uses a patent-pending combination of three different heat sources – convection, grill and a heated base – to deliver fast results. Space-saving and compact, it operates from a 13-amp plug and is ventless.

To find out more about CiBO and see it in action, visit www.cibo-oven.com

Produce a wide range of perfectly-cooked food in less than three minutes.

Benefits at a glance

- Cook, toast and reheat, fresh and frozen foods
- Space-saving and compact
- Plug and play - on a 3-pin 3kW UK plug
- Ventless cooking - catalyst technology
- Clear icons and an easy-to-use touchscreen
- Replace your panini grill, toaster, convection oven and grill



CiBO MENU

12 Months Profit Opportunity

CLUB
sourdough
SANDWICH
£8,320

BREAKFAST
Bap
£2,964

REUBEN
Panini
£5,850

NACHOS

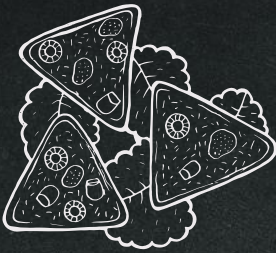

£8,580

12" PIZZA *Fresh Dough*

£12,532

 **CROISSANTS**
£2,314

To find out more about the profit a CiBO can deliver please visit

cibo-oven.com

Fast Ovens

2 YEAR UK parts and labour warranty | Export parts warranty on all Lincat products

- Cook, toast and reheat, fresh and frozen foods
- Plug and play – on a 3 pin 3kW UK plug
- Ventless cooking – catalyst technology
- Clear icons and an easy-to-use touchscreen
- Replace your panini grill, toaster, convection oven and grill

CiBO fast ovens							
MODEL	PRICE £	PRICE €	H	W	D	POWER	WT
CiBO/B	£4079	€4691	367	437	616	2.7kW	37.5
CiBO/C	£4079	€4691	367	437	616	2.7kW	37.5
CiBO/M	£4079	€4691	367	437	616	2.7kW	37.5
CiBO/S	£4079	€4691	367	437	616	2.7kW	37.5
CiBO/T	£4079	€4691	367	437	616	2.7kW	37.5
Internal usable dimensions			95	340	355		

MODEL	PRICE £	PRICE €	DESCRIPTION
A CiBO/PL	£121	€140	Plinth
A CiBO/WB	£298	€343	Wall bracket
A CiBO/SK	£114	€132	Stacking kit
A CiBO/BT	£65	€75	Baking tray
A LT01	£63	€73	Paddle
A SH136	£19.80	€22.80	Wire rack
C TFS05	£12	€14	Teflon sheet
A CiBO/USB	£29	€34	USB stick
C CiBO/TT	£74	€86	Teflon basket
A CiBO/BRT	£186	€214	Branding tray
C NSBT23	£118	€136	Non stick baking tray

Included with the oven:

- LT01 Paddle
- TF505 Teflon Sheet
- SH136 Wire Rack
- CiBO/TT Teflon Basket
- CiBO/BT Baking Tray



Plinth



Wall bracket



Stacking kit



Baking tray

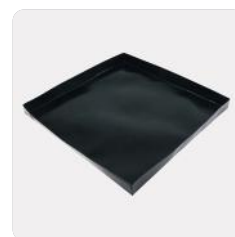

Teflon basket



Paddle



Wire rack



Teflon sheet



USB stick

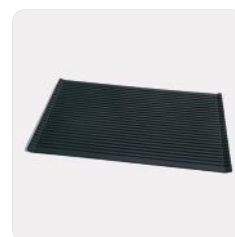

Branding tray

How does it work?



Cibo uses a patent pending combination of three different heat sources – convection, grill and a heated base.

Phased cooking programmes enable each of the three heat sources to switch on and off during the cook cycle to deliver fast results. This produces high-quality, perfectly-cooked food in 2-3 minutes.

Features

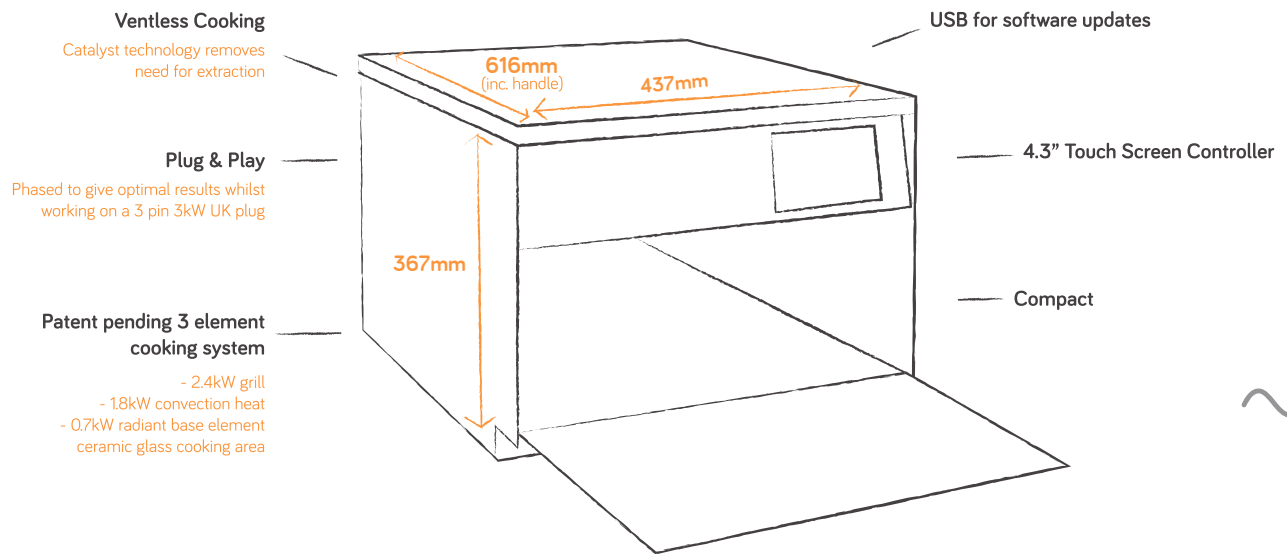

Simple to use

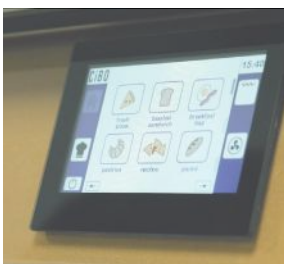

Simplicity is at the heart of Cibo.

Simple food icons make it easy to use and overcome any language barriers. Choose a dish, press play and Cibo will do the rest.

Optimising your Cibo

When it comes to creating something new with Cibo, the world is your oyster. Cibo allows you to get creative and push boundaries, and developing your own bespoke menu programmes.

This optimisation makes it easy for staff of all skill levels to use Cibo. They can create perfectly-cooked, high-quality food, time after time.

Many menu items and settings to choose from

Cibo has the space for up to 24 cook programmes, including 11 pre-programmed menu items. Colour icons are the perfect solution for outlets with extensive menus. Operators can group

together items that are cooked in the same way and assign them a specific cook programme and colour – creating a simple system for all staff and skill levels.

Opus 800



The Opus 800 series is built for power and performance.

High volume, high quality cooking is simple with the powerful Opus 800 series of 800mm deep oven ranges, boiling tops, fryers, grills, griddles, and bratt pans.

Designed to heat quickly, the Opus 800 series is made for non-stop establishments where kitchens are a constant hive of activity. The equipment can go on cooking delicious dishes all day long, from breakfast through to midnight.

The strong, durable series comes with both electric and gas models, and can be configured in a variety of ways, such as with pedestals and stands. Create a seamless, stylish look that's perfect for front of house and open kitchens.

Ideally suited for...

The heavy-duty Opus 800 series is perfect for the most demanding of kitchens. If your kitchen barely stops, then Opus 800 is the series for you.



Large chain pubs and restaurants

Is your kitchen constantly under pressure to deliver delicious dishes at high volumes? If so, you'll find what you're looking for in the Opus 800 series.



Large hospitals

If you need to cook a vast quantity of meals for patients, the Opus 800 series has the capacity to deliver time after time.



Schools

Hundreds of children waiting for their lunchtime meal is no reason to stress when you've got the heavy-duty Opus 800 series ready to go in your kitchen.



Care homes

The Opus 800 series is designed for high output - perfect for when you've got to cook lots of meals at set times for residents.

The power of the Opus 800 series means it can deliver vast quantities of quality food. It won't let you down.

Benefits at a glance

- 800mm deep
- Heavy duty
- For high output establishments cooking all day long
- Enhanced performance
- Strong and durable
- Increased capacity
- Gas and electric models
- Easy to clean



Most Opus 800 products are SUPPLIED WITH CASTORS AS STANDARD

Please contact us if you require products to be supplied with legs



Opus 800

All gas power ratings are nominal values.

Gas Oven Ranges

Gas open top hob

- 7.5kW dual concentric burners for focused heat distribution from a fast boil to a low simmer
- Individual heavy-duty single cast iron supports, built to withstand the rigours of the busiest kitchen
- Flame failure protection
- Low flue to allow use of the complete hob top
- Drip tray

Inclusive Accessories

- 2 chrome plated shelves



4 burner gas range							
MODEL	PRICE £	PRICE €	H	W	D	POWER	WT
OG8001/N	£4226	€4860	920	600	800	36.8kW	112
OG8001/P	£4226	€4860	920	600	800	33.6kW	112
OG8001/N/RHD	£4436	€5102	920	600	800	36.8kW	131
OG8001/P/RHD	£4436	€5102	920	600	800	33.6kW	131
Internal usable dimensions			405	495	530		

/RHD - right hinged door

MODEL	PRICE £	PRICE €	DESCRIPTION
A OA8901	£457	€526	Splashback/shelf

6 burner gas range							
MODEL	PRICE £	PRICE €	H	W	D	POWER	WT
OG8002/N	£4237	€4873	920	900	800	55kW	149
OG8002/P	£4237	€4873	920	900	800	50.5kW	149
Internal usable dimensions			405	715	530		

MODEL	PRICE £	PRICE €	DESCRIPTION
A OA8902	£554	€638	Splashback/shelf

6 burner gas range with drop down door							
MODEL	PRICE £	PRICE €	H	W	D	POWER	WT
OG8002/N/DD	£4475	€5147	920	900	800	55kW	172
OG8002/P/DD	£4475	€5147	920	900	800	50.5kW	172
Internal usable dimensions			405	715	530		

MODEL	PRICE £	PRICE €	DESCRIPTION
A OA8902	£554	€638	Splashback/shelf

Dual Fuel Oven Ranges

Gas open top hob

- 7.5kW dual concentric burners for focused heat distribution from a fast boil to a low simmer
- Individual heavy-duty single cast iron supports, built to withstand the rigours of the busiest kitchen
- Flame failure protection
- Low flue to allow use of the complete hob top
- Drip tray

Inclusive Accessories

- 3 chrome plated shelves

Oven

- 4kW (OD8006) and 6kW (OD8007) ovens
- Precise thermostatic control from 130°C to 250°C
- Twin fan assisted oven for uniform heat and consistent cooking results (OD8006 single fan only)
- Large capacity oven, 3 x GN1/1 (OD8006) and 6 x GN1/1 (OD8007)
- 3 shelves and 5 shelf positions maximize oven space
- Removable oven base for easy cleaning
- Double insulated doors, side and back panels for safe operation, efficiency and economy



2 YEAR UK parts and labour warranty | Export parts warranty
on all Lincat products

Key

H = Height (mm)
W = Width (mm)
D = Depth (mm)
WT = Packed Weight in kg



4 burner dual fuel range								
MODEL	PRICE £	PRICE €	H	W	D	POWER	OVEN POWER	WT
*OD8006/N	£5148	€5921	912	600	800	30kW	4kW	167
*OD8006/P	£5148	€5921	912	600	800	26.8kW	4kW	167
Internal usable dimensions			410	525	530			

MODEL	PRICE £	PRICE €	DESCRIPTION
A OA8984	£457	€526	Splashback/shelf

6 burner dual fuel range								
MODEL	PRICE £	PRICE €	H	W	D	POWER	OVEN POWER	WT
*OD8007/N	£6945	€7987	912	900	800	45kW	6kW	201
*OD8007/P	£6945	€7987	912	900	800	40.2kW	6kW	201
Internal usable dimensions			410	825	530			

MODEL	PRICE £	PRICE €	DESCRIPTION
A OA8985	£554	€638	Splashback/shelf

* Please refer to pages L90 to L91 for electricity supply requirements

Gas Solid Top Range

Gas solid top

- Powerful burner produces consistent heat gradient throughout the plate
- Flame failure protection
- 3 piece, heavy duty cast iron top with removable bull's eye
- Profiled underside of cast iron top for optimum heat circulation
- Low flue to allow use of the complete hob top

Oven

- Precise thermostatic control from 120°C to 260°C
- Large capacity oven, 4 x GN1/1
- 2 shelves and 4 shelf positions maximise oven space
- Removable oven base for easy cleaning
- Double insulated doors, side and back panels for safe operation, efficiency and economy

Inclusive Accessories

- 2 chrome plated shelves
- Bull's eye lifting poker

2
YEARUK parts
and labour
warranty
Export
parts
warranty
on all Lincat products

Electric Solid Top Range

Electric solid top

- Twin zone full width heavy-duty hot plate maximises cooking space
- Two 2.7kW and two 2kW elements produce controllable heat gradient throughout the cast iron plate - use the central areas for rapid boiling and outer areas for simmering and holding

Oven

- 6kW oven
- Precise thermostatic control from 130°C to 250°C
- Twin fan assisted oven for uniform heat and consistent cooking results
- Large capacity oven, 6 x GN1/1
- 3 shelves and 5 shelf positions maximise oven space

Inclusive Accessories

- 3 chrome plated shelves



Solid top gas range							
MODEL	PRICE £	PRICE €	H	W	D	POWER	WT
OG8005/N	£6020	€6923	900	900	800	18.5kW	173
OG8005/P	£6020	€6923	900	900	800	19kW	173
Internal usable dimensions			405	715	530		

Solid top gas range with drop down door							
MODEL	PRICE £	PRICE €	H	W	D	POWER	WT
OG8005/N/DD	£6910	€7947	900	900	800	18.5kW	173
OG8005/P/DD	£6910	€7947	900	900	800	19kW	173
Internal usable dimensions			405	715	530		

Solid top gas range							
MODEL	PRICE £	PRICE €	H	W	D	POWER	WT
*OE8015	£7656	€8805	900	900	800	15.4kW	201
Internal usable dimensions			405	825	530		

MODEL	PRICE £	PRICE €	DESCRIPTION
A OA8980	£548	€631	Splashback/shelf

MODEL	PRICE £	PRICE €	DESCRIPTION
A OA8980	£548	€631	Splashback/shelf

MODEL	PRICE £	PRICE €	DESCRIPTION
A OA8983	£554	€638	Splashback/shelf

Electric Oven Ranges

Electric hob top

- Heavy-duty cast iron 2.6kW hotplates deliver fast responsive heat
- Choice of round or square hotplates
- Fully pressed sealed hob for easy cleaning

Inclusive Accessories

- 2 chrome plated shelves

Oven

- 4kW (OE8010) and 6kW (OE8008 and OE8016) ovens
- Precise thermostatic control from 130°C to 250°C
- Twin fan assisted oven for uniform heat and consistent cooking results (OE8010 single fan only)
- Large capacity oven, 2 x GN1/1 (OE8010) and 4 x GN1/1 (OE8008 and OE8016)
- 2 shelves and 5 shelf positions maximise oven space
- Removable oven base for easy cleaning
- Double insulated doors, side and back panels for safe operation, efficiency and economy



4 hotplate (square) electric range							
MODEL	PRICE £	PRICE €	H	W	D	POWER	WT
*OE8010	£5936	€6827	925	600	800	14.4kW	109
Internal usable dimensions			405	495	530		

6 hotplate (square) electric range							
MODEL	PRICE £	PRICE €	H	W	D	POWER	WT
*OE8008	£7768	€8934	925	900	800	21.6kW	152
Internal usable dimensions			405	715	512		

6 hotplate (round) electric range							
MODEL	PRICE £	PRICE €	H	W	D	POWER	WT
*OE8016	£6655	€7654	925	900	800	21.6kW	147
Internal usable dimensions			405	715	512		

MODEL	PRICE £	PRICE €	DESCRIPTION
A OA8981	£457	€526	Splashback/shelf

MODEL	PRICE £	PRICE €	DESCRIPTION
A OA8982	£554	€638	Splashback/shelf

MODEL	PRICE £	PRICE €	DESCRIPTION
A OA8982	£554	€638	Splashback/shelf

* Please refer to pages L90 to L91 for electricity supply requirements

Opus 800

All gas power ratings are nominal values. Gas counter top equipment is supplied on 150mm high legs in compliance with CE legislation. Electric counter top equipment is supplied on height adjustable 55-70mm high legs.

Induction Range

Induction hob

- 5kW induction zones
- 270mm diameter induction cooking zones
- Automatic pan detection function cuts power when no pan is present, preventing harm to users, while saving energy
- 6mm thick high impact resistant glass ceramic surface will withstand hard knocks and is easy to clean
- Multiple internal cooling fans and overheat protection for long service life
- Easy to change filters

Inclusive Accessories

- 2 chrome plated shelves

Oven

- 4kW oven
- Precise thermostatic control from 130°C to 250°C
- Fan assisted oven for uniform heat and consistent cooking results
- Large capacity oven accommodates 2 x GN1/1 containers
- 2 shelves and 5 shelf positions maximize oven space
- Removable oven base for easy cleaning
- Double insulated doors, side and back panels for safe operation, efficiency and economy
- Reduced power options available on request



4 zone induction oven range							
MODEL	PRICE £	PRICE €	H	W	D	POWER	WT
*OE8017	£15,883	€18,266	900	900	800	24kW	153
Internal usable dimensions			420	525	510		

MODEL	PRICE £	PRICE €	DESCRIPTION
S FI41	£14	€17	Air filter

Gas Boiling Tops

- 7.5kW dual concentric burners for focused heat distribution from a fast boil to a low simmer
- Individual heavy duty single cast iron supports, built to withstand the rigours of the busiest kitchen
- Flame failure protection
- Low flue to allow use of the complete hob top
- Drip tray



2 burner gas boiling top							
MODEL	PRICE £	PRICE €	H	W	D	POWER	WT
OG8009/N	£2037	€2343	412	300	800	15kW	40
OG8009/P	£2037	€2343	412	300	800	13.6kW	40

4 burner gas boiling top							
MODEL	PRICE £	PRICE €	H	W	D	POWER	WT
OG8003/N	£2943	€3385	412	600	800	30kW	64
OG8003/P	£2943	€3385	412	600	800	27.2kW	64

4 burner gas boiling top							
MODEL	PRICE £	PRICE €	H	W	D	POWER	WT
OG8004/N	£3820	€4393	412	900	800	45kW	89
OG8004/P	£3820	€4393	412	900	800	40.8kW	89

MODEL	PRICE £	PRICE €	DESCRIPTION
OA8970	£711	€818	Pedestal with doors
OA8934	£711	€818	Floor stand

MODEL	PRICE £	PRICE €	DESCRIPTION
OA8972	£783	€901	Pedestal with doors
OA8972/C	£783	€901	Pedestal with doors and castors
OA8917	£783	€901	Floor stand
OA8917/C	£783	€901	Floor stand with castors

MODEL	PRICE £	PRICE €	DESCRIPTION
OA8973	£851	€979	Pedestal with doors
OA8973/C	£851	€979	Pedestal with doors and castors
OA8914	£851	€979	Floor stand
OA8914/C	£851	€979	Floor stand with castors

Electric Boiling Tops

- Heavy duty cast iron 2.6kW hotplates deliver fast responsive heat
- Fully pressed sealed hob for easy cleaning



4 hotplate electric boiling top							
MODEL	PRICE £	PRICE €	H	W	D	POWER	WT
*OE8012	£3436	€3952	325	600	800	10.4kW	73

6 hotplate electric boiling top							
MODEL	PRICE £	PRICE €	H	W	D	POWER	WT
*OE8011	£4490	€5164	325	900	800	15.6kW	84

MODEL	PRICE £	PRICE €	DESCRIPTION
OA8972	£783	€901	Pedestal with doors
OA8972/C	£783	€901	Pedestal with doors and castors
OA8917	£783	€901	Floor stand
OA8917/C	£783	€901	Floor stand with castors
LK11	£61	€71	Long leg kit

MODEL	PRICE £	PRICE €	DESCRIPTION
OA8973	£851	€979	Pedestal with doors
OA8973/C	£851	€979	Pedestal with doors and castors
OA8914	£851	€979	Floor stand
OA8914/C	£851	€979	Floor stand with castors
LK11	£61	€71	Long leg kit

2

UK parts
and labour
warranty
on all Lincat products

Export
parts
warranty

Product Codes

/N = natural gas /P = propane gas Btu/hr = kW x 3412

Opus 800

Induction Hobs

- 5kW induction zones
- Automatic pan detection function cuts power when no pan is present, preventing harm to users, while saving energy
- 6mm thick high impact resistant glass ceramic surface will withstand hard knocks and is easy to clean
- Multiple internal cooling fans and overheat protection for long service life
- Easy to change filter, built into the base of the unit

220mm diameter induction cooking zones



2 zone induction hob (twin)							
MODEL	PRICE £	PRICE €	H	W	D	POWER	WT
*OE8013	£6509	€7486	300	300	800	10.6kW	32

4 zone induction hob (quad)							
MODEL	PRICE £	PRICE €	H	W	D	POWER	WT
*OE8014	£12,228	€14,063	300	600	800	21.2kW	63

MODEL	PRICE £	PRICE €	DESCRIPTION
A OA8970	£711	€818	Pedestal with doors
A OA8934	£711	€818	Floor stand
S FI36	£14	€17	Air filter
A LK11	£61	€71	Long leg kit

MODEL	PRICE £	PRICE €	DESCRIPTION
A OA8972	£783	€901	Pedestal with doors
A OA8972/C	£783	€783	Pedestal with doors with castors
A OA8917	£783	€783	Floor stand
A OA8917/C	£783	€783	Floor stand with castors
S FI36	£14	€17	Air filter
A LK11	£61	€71	Long leg kit

270mm diameter induction cooking zones



2 zone induction hob (twin)							
MODEL	PRICE £	PRICE €	H	W	D	POWER	WT
*OE8018	£7036	€8092	300	400	800	10.6kW	44

4 zone induction hob (quad)							
MODEL	PRICE £	PRICE €	H	W	D	POWER	WT
*OE8019	£12,663	€14,563	300	800	800	21.2kW	77

MODEL	PRICE £	PRICE €	DESCRIPTION
A OA8971	£738	€849	Pedestal with doors
A OA8921	£738	€849	Floor stand
S FI36	£14	€17	Air filter
A LK11	£61	€71	Long leg kit

MODEL	PRICE £	PRICE €	DESCRIPTION
A OA8974	£827	€952	Pedestal with doors
A OA8974/C	£827	€952	Pedestal with doors with castors
A OA8956	£827	€952	Floor stand
A OA8956/C	£827	€952	Floor stand with castors
S FI36	£14	€17	Air filter
A LK11	£61	€71	Long leg kit

Key

H	= Height (mm)
W	= Width (mm)
D	= Depth (mm)
WT	= Packed Weight in kg

Opus 800

All gas power ratings are nominal values.

Oil Management

All Opus 800 series gas and electric fryers are available as a base model with oil drainage through the body of the fryer. A gravity filtration accessory adds in-built filtration to the fryer, and the pumped filtration option provides the ultimate in convenience.

Gravity filtration accessory

The integral gravity filtration accessory converts the base model into a fryer with two-stage gravity filtration. This extends oil life, reduces disposal costs and provides a better tasting product for longer.



Pumped filtration option (/OP)

The integral pumped filtration option enables oil to be filtered and the fryer ready for use again in less than 5 minutes. Oil can be filtered during or after service, even whilst hot, maximising oil life. This eliminates the need to lift heavy containers, reducing contact with hot oil and the chances of hazardous spillages.

This option is supplied with a hose with lance for easy discharge of oil into a waste container.

Twin tank pumped filtration (/OP2)

The /OP2 version for twin tank fryers has two oil pumps and two buckets, which is designed to remove cross contamination of the oil from either side of the fryer.

This option is supplied with 2 hoses with lance for easy discharge of oil into a waste container.



Vortech High Efficiency Gas Fryer

- 97% energy efficiency rating verified in independent BSI tests delivers substantially lower running costs and higher output
- Typical payback within 23 months
- Two stage filtration removes contaminants and particles, extending oil life by up to 75% and so reducing oil costs
- Pumped oil return enables the oil to be filtered and the fryer ready for use again in less than five minutes - safe and convenient
- Oil can be filtered during or after service even whilst hot
- Convenient electronic ignition
- Supplied with a hose with lance for easy discharge of oil into a waste container

Inclusive Accessories

- Batter plate
- Full lid
- Baskets
- Stainless steel bucket



Vortech gas fryer								
MODEL	PRICE £	PRICE €	H	W	D	POWER	OIL CAP	WT
OG8115/OP/N	£11,691	€13,445	1070	400	800	22kW	16L	108
OG8115/OP/P	£11,691	€13,445	1070	400	800	22kW	16L	108

Will accept 1 x BA82 basket

MODEL	PRICE £	PRICE €	DESCRIPTION
A BA82	£122	€141	Large fryer basket with doors
A OA8961	£293	€337	Side splashguard (left and right)
A OA8935	£295	€340	Vortech fryer batter tray and holder



Most Opus 800 products are SUPPLIED WITH CASTORS AS STANDARD

Please contact us if you require products to be supplied with legs

Key

H = Height (mm)
W = Width (mm)
D = Depth (mm)
WT = Packed Weight in kg

2
YEAR

UK parts and labour warranty

Export parts warranty

on all Lincat products

Opus 800

Gas Fryers

- Accurate thermostatic control up to 190°C for consistent results and safe operation
- High energy efficiency
- Convenient piezo ignition
- Externally fired heating gives easy access for cleaning tanks
- Gravity filtration accessory available for all base models
- /OP Pumped filtration option available on all models
- Model OG8111 features two independently controlled fryer tanks for greater versatility
- For safety and stability, 300mm and 400mm wide fryers are supplied with front legs and rear castors

Inclusive Accessories

- Batter plate
- Baskets
- Full lid
- Stainless steel bucket



Single tank gas fryer (300mm wide)								
MODEL	PRICE £	PRICE €	H	W	D	POWER	OIL CAP	WT
OG8110/N	£4390	€5049	1020	300	815	16kW	14L	83
OG8110/P	£4390	€5049	1020	300	815	16kW	14L	83
‡OG8110/OP/N	£7897	€9082	1070	300	815	16kW	14L	96
‡OG8110/OP/P	£7897	€9082	1070	300	815	16kW	14L	96

Supplied with 1 x BA165 basket

MODEL	PRICE £	PRICE €	DESCRIPTION
A OA8955	£293	€337	Side splashguard (left and right)
A OF1	£231	€266	Gravity filtration kit (OG810 only)

Single tank gas fryer (400mm wide)								
MODEL	PRICE £	PRICE €	H	W	D	POWER	OIL CAP	WT
OG8106/N	£4523	€5202	1020	400	800	23kW	16L	98
OG8106/P	£4523	€5202	1020	400	800	23kW	16L	98
‡OG8106/OP/N	£7908	€9095	1070	400	800	23kW	16L	104
‡OG8106/OP/P	£7908	€9095	1070	400	800	23kW	16L	104

Supplied with 2 x BA159 baskets

MODEL	PRICE £	PRICE €	DESCRIPTION
A BA82	£122	€141	Large fryer basket (will accept x 1)
A OA8955	£293	€337	Side splashguard (left and right)
A OF2	£264	€304	Gravity filtration kit (OG8106 only)



Single tank gas fryer (600mm wide)								
MODEL	PRICE £	PRICE €	H	W	D	POWER	OIL CAP	WT
OG8107/N	£5148	€5921	1020	600	800	30kW	25L	125
OG8107/P	£5148	€5921	1020	600	800	30kW	25L	125
‡OG8107/OP/N	£8533	€9813	1070	600	800	30kW	25L	135
‡OG8107/OP/P	£8533	€9813	1070	600	800	30kW	25L	135

Supplied with 2 x BA82 baskets

MODEL	PRICE £	PRICE €	DESCRIPTION
A BA159	£137	€158	Large fryer basket (will accept x 1)
A OA8955	£293	€337	Side splashguard (left and right)
A OF2	£264	€304	Gravity filtration kit (OG8107 only)

Twin tank gas fryer (600mm wide)								
MODEL	PRICE £	PRICE €	H	W	D	POWER	OIL CAP	WT
OG8111/N	£6556	€7540	1020	600	800	32kW	2 x 14L	142
OG8111/P	£6556	€7540	1020	600	800	32kW	2 x 14L	142
‡OG8111/OP/N	£9943	€11,435	1070	600	800	32kW	2 x 14L	151
‡OG8111/OP/P	£9943	€11,435	1070	600	800	32kW	2 x 14L	151
‡OG8111/OP2/N	£12,648	€14,546	1070	600	800	32kW	2 x 14L	157
‡OG8111/OP2/P	£12,648	€14,546	1070	600	800	32kW	2 x 14L	157

Supplied with 2 x BA165 baskets



Gas fryers with pumped filtration (/OP & /OP2) require a 1 phase connection

Product Codes

/N = natural gas /P = propane gas Btu/hr = kW x 3412

‡No electricity supply required (except with /OP and /OP2 models)

Electric Fryers

- Accurate thermostatic control up to 190°C for consistent results and safe operation
- Hinged, lift out element, with safety interlock for easy tank access and cleaning
- Models OE8105 and OE8113 feature two independently controlled fryer tanks for greater versatility
- Gravity filtration accessory available for all base models
- /OP Pumped filtration option available on all models
- For safety and stability, 300mm and 400mm wide fryers are supplied with front legs and rear castors

Inclusive Accessories

- Batter plate
- Baskets
- Full lid
- Stainless steel bucket



Single tank electric fryer (300mm wide)								
MODEL	PRICE £	PRICE €	H	W	D	POWER	OIL CAP	WT
*OE8112	£3290	€3784	1020	300	800	12kW	15L	72
*OE8112/OP	£6645	€7642	1070	300	800	12kW	15L	79

Supplied with 1 x BA82 basket

Single tank electric fryer (400mm wide)								
MODEL	PRICE £	PRICE €	H	W	D	POWER	OIL CAP	WT
*OE8114	£4175	€4802	1020	400	800	14kW	19L	81
*OE8114/OP	£7502	€8628	1070	400	800	14kW	19L	90

Supplied with 2 x BA83 baskets

Twin tank electric fryer (400mm wide)								
MODEL	PRICE £	PRICE €	H	W	D	POWER	OIL CAP	WT
*OE8105	£4723	€5432	1020	400	800	14kW	2 x 9.5L	87
*OE8105/OP	£7884	€9067	1070	400	800	14kW	2 x 9.5L	97
*OE8105/OP2	£10,582	€12,170	1070	400	800	14kW	2 x 9.5L	101

Supplied with 2 x BA83 baskets

MODEL	PRICE £	PRICE €	DESCRIPTION
A BA122	£126	€145	Small fryer basket (will accept x 2)
A OA8954	£293	€337	Side splashguard (left and right)
A OF1	£231	€266	Gravity filtration kit (OE8112 only)

MODEL	PRICE £	PRICE €	DESCRIPTION
A OA8954	£293	€337	Side splashguard (left and right)
A OF2	£264	€304	Gravity filtration kit (OE8114 only)

MODEL	PRICE £	PRICE €	DESCRIPTION
A OA8954	£293	€337	Side splashguard (left and right)
A OF2	£264	€304	Gravity filtration kit (OE8105 only)

2
YEARUK parts
and labour
warrantyExport
parts
warrantyon all Lincat
products

Single tank electric fryer (600mm wide)								
MODEL	PRICE £	PRICE €	H	W	D	POWER	OIL CAP	WT
*OE8108	£4849	€5577	1020	600	800	22kW	36.5L	109
*OE8108/OP	£8157	€9381	1070	600	800	22kW	36.5L	115

Supplied with 2 x BA82 basket

Twin tank electric fryer (600mm wide)								
MODEL	PRICE £	PRICE €	H	W	D	POWER	OIL CAP	WT
*OE8113	£5234	€6020	1020	600	800	24kW	2 x 15L	111
*OE8113/OP	£8529	€9809	1070	600	800	24kW	2 x 15L	118
*OE8113/OP2	£11,276	€12,968	1070	600	800	24kW	2 x 15L	131

Supplied with 2 x BA82 basket

MODEL	PRICE £	PRICE €	DESCRIPTION
A BA83	£135	€156	Small fryer basket (will accept x 3)
A OA8954	£293	€337	Side splashguard (left and right)
A OF2	£264	€304	Gravity filtration kit (OE8108 only)

MODEL	PRICE £	PRICE €	DESCRIPTION
A BA122	£126	€145	Small fryer basket (will accept x 4)
A OA8954	£293	€337	Side splashguard (left and right)
A OF2	£264	€304	Gravity filtration kit (OE8113 only)

Key

H = Height (mm)
W = Width (mm)
D = Depth (mm)
WT = Packed Weight in kg

Opus 800

All gas power ratings are nominal values.

Gas Salamander Grills

- Powerful, highly efficient ceramic plaque burners for reliability and rapid heat up
- Three independently controlled heat zones on the OG8302 for maximum versatility
- Four shelf positions with horizontal or angled settings
- OG8302 is GN 1/1 compatible
- Enamelled front for durability
- Flame failure protection

Inclusive Accessories

- Reversible cast aluminium branding plate, with removable fat collection container (OG8302 only)

Electric Salamander Grills

- Powerful heating elements, for reliability and rapid heat up
- Left and right independently controlled heat zones on the OE8303 for maximum versatility
- Four shelf positions with horizontal or angled settings
- OE8303 is GN 1/1 compatible
- Enamelled front for durability

Inclusive Accessories

- Reversible cast aluminium branding plate, with removable fat collection container (OE8303 only)



Gas salamander							
MODEL	PRICE £	PRICE €	H	W	D	POWER	WT
OG8301/N	£2434	€2800	450	800	438	6kW	48
OG8301/P	£2434	€2800	450	800	438	6.8kW	48

Gas salamander							
MODEL	PRICE £	PRICE €	H	W	D	POWER	WT
OG8302/N	£3855	€4434	495	900	548	8.7kW	73
OG8302/P	£3855	€4434	495	900	548	9kW	73

Electric salamander							
MODEL	PRICE £	PRICE €	H	W	D	POWER	WT
*OE8304	£2148	€2471	400	800	415	4.4kW	46

Electric salamander							
MODEL	PRICE £	PRICE €	H	W	D	POWER	WT
*OE8303	£3246	€3733	510	890	520	5.4kW	72

MODEL	PRICE £	PRICE €	DESCRIPTION
A OA8907	£742	€854	Floor stand for OG8301
A OA8912	£827	€952	Floor stand for OG8302
A OA8908	£538	€619	Bench stand for OG8301
A OA8918	£582	€670	Bench stand for OG8302
A OA8909	£244	€281	Wall bracket for OG8301
A OA8911	£301	€347	Wall bracket for OG8302
A OA8976	£252	€290	Branding plate for OG8301
A BR10	£334	€385	Additional branding plate for OG8302

Salamander floor stands cannot be supplied with castors

MODEL	PRICE £	PRICE €	DESCRIPTION
A OA8907	£742	€854	Floor stand for OE8304
A OA8912	£827	€952	Floor stand for OE8303
A OA8908	£538	€619	Bench stand for OE8304
A OA8918	£582	€670	Bench stand for OE8303
A OA8909	£244	€281	Wall bracket for OE8304
A OA8911	£301	€347	Wall bracket for OE8303
A OA8976	£252	€290	Branding plate for OE8304
A BR10	£334	€385	Additional branding plate for OE8303

Salamander floor stands cannot be supplied with castors

Electric Cook & Hold Salamander

The sophisticated Cook & Hold Salamander heats up in just eight seconds when the plate detection mechanism is activated by a plate or gastronorm pan. Once the food is cooked, the hold function will ensure food is kept warm but does not continue to cook until required for service. Once the plate is removed and the plate detection mechanism freed, the elements automatically switch off saving energy.

- Cook and hold function
- Fast heat up 'Hi-Light' elements – ready to cook in just eight seconds
- Self-balancing height adjustable grill hood for easy operation
- Three independently controlled heating zones for maximum flexibility
- Touchpad control with digital display of time and power settings
- 20 minute audible timer
- GN1/1 compatible
- Suitable for wall or bench mounting
- Suitable for single or three phase installation

2
YEAR

UK parts
and labour
warranty

Export
parts
warranty

on all Lincat products



Electric cook and hold salamander							
MODEL	PRICE £	PRICE €	H	W	D	POWER	WT
*OE8306	£4473	€5144	544	600	562	4.5kW	89

Supplied on height adjustable 25-45mm high legs

MODEL	PRICE £	PRICE €	DESCRIPTION
A BR75	£255	€294	Wall bracket

* Please refer to pages L90 to L91 for electricity supply requirements

Opus 800

All gas power ratings are nominal values. Gas counter top equipment is supplied on 150mm high legs in compliance with CE legislation.
Electric counter top equipment is supplied on height adjustable 55-70mm high legs.

Gas Griddles

- Maximised cooking area, griddle plates sit flush to the sides of the unit
- Left and right independently controlled heat zones for flexibility and economy during quiet periods
- Precise thermostatic control from 90°C - 280°C for consistent results and economical operation
- Half-ribbed plate option (/R), for attractive branding presentation marks

- Chrome plate option (/C), easy to clean and reduced heat radiation for a comfortable working environment and reduced energy costs
- Convenient piezo ignition and pilot burners for stand-by operation
- Flame failure protection

Inclusive Accessories

- Scraper (not for chrome models)



Gas griddles (mached steel)							
MODEL	PRICE £	PRICE €	H	W	D	POWER	WT
OG8201/N	£4064	€4674	532	600	800	15.5kW	93
OG8201/P	£4064	€4674	532	600	800	15.5kW	93
OG8202/N	£4630	€5325	532	900	800	23kW	124
OG8202/P	£4630	€5325	532	900	800	23kW	124

Gas griddles (chrome)							
MODEL	PRICE £	PRICE €	H	W	D	POWER	WT
OG8201/C/N	£6364	€7319	532	600	800	15.5kW	93
OG8201/C/P	£6364	€7319	532	600	800	15.5kW	93
OG8202/C/N	£7451	€8569	532	900	800	23kW	124
OG8202/C/P	£7451	€8569	532	900	800	23kW	124

Gas griddles (half-ribbed steel)							
MODEL	PRICE £	PRICE €	H	W	D	POWER	WT
OG8201/R/N	£4455	€5124	532	600	800	15.5kW	90
OG8201/R/P	£4455	€5124	532	600	800	15.5kW	90
OG8202/R/N	£5127	€5897	532	900	800	23kW	140
OG8202/R/P	£5127	€5897	532	900	800	23kW	140

MODEL	PRICE £	PRICE €	DESCRIPTION
A OA8972	£783	€901	Pedestal with doors for OG8201
A OA8972/C	£783	€901	Pedestal with doors and castors for OG8201
A OA8917	£783	€901	Floor stand for OG8201
A OA8917/C	£783	€901	Floor stand with castors for OG8201
A OA8973	£851	€979	Pedestal with doors for OG8202
A OA8973/C	£851	€979	Pedestal with doors and castors for OG8202
A OA8914	£851	€979	Floor stand for OG8202
A OA8914/C	£851	€979	Floor stand with castors for OG8202

Electric Griddles

- Maximised cooking area, griddle plates sit flush to the sides of the unit
- Left and right independently controlled heat zones for flexibility and economy during quiet periods
- Precise thermostatic control from 90°C - 300°C for consistent results and economical operation
- Half-ribbed plate option (/R), for attractive branding presentation marks

- Chrome plate option (/C), easy to clean and reduced heat radiation for a comfortable working environment and reduced energy costs

Inclusive Accessories

- Scraper (not for chrome models)



Electric griddles (mached steel)							
MODEL	PRICE £	PRICE €	H	W	D	POWER	WT
*OE8205	£2888	€3322	428	600	800	8kW	93
*OE8206	£3421	€3935	428	900	800	12kW	128

Electric griddles (chrome)							
MODEL	PRICE £	PRICE €	H	W	D	POWER	WT
*OE8205/C	£5146	€5918	428	600	800	8kW	95
*OE8206/C	£6187	€7116	428	900	800	12kW	134

Electric griddles (half-ribbed steel)							
MODEL	PRICE £	PRICE €	H	W	D	POWER	WT
*OE8205/R	£3236	€3722	428	600	800	8kW	92
*OE8206/R	£3863	€4443	428	900	800	12kW	124

MODEL	PRICE £	PRICE €	DESCRIPTION
A OA8972	£783	€901	Pedestal with doors for OE8205
A OA8972/C	£783	€901	Pedestal with doors and castors for OE8205
A OA8917	£783	€901	Floor stand for OE8205
A OA8917/C	£783	€901	Floor stand with castors for OE8205
A OA8973	£851	€979	Pedestal with doors for OE8206
A OA8973/C	£851	€979	Pedestal with doors and castors for OE8206
A OA8914	£851	€979	Floor stand for OE8206
A OA8914/C	£851	€979	Floor stand with castors for OE8206

Electric Clam Griddles

Opus 800 clam griddles cook food up to three times as quickly as a standard griddle. Double griddle plates heat both sides of the food simultaneously, delivering fast, even and repeatable results

- Precise thermostatic temperature control for consistent results and economical operation
- Independently controlled cooking zones for greater flexibility and economy during quieter periods

- Digital timer on each clam plate ensures repeatable results
- Ribbed plate option (/R), for attractive branding presentation marks

Inclusive Accessories

- Scraper
- PTFE non-stick sheets

Key

H	=	Height (mm)
W	=	Width (mm)
D	=	Depth (mm)
WT	=	Packed Weight in kg



Electric clam griddles (flat upper plate)							
MODEL	PRICE £	PRICE €	H	W	D	POWER	WT
*OE8211	£9156	€10,530	542	400	800	8.6kW	95
*OE8210	£14,448	€16,616	542	800	800	17.2kW	192

Electric clam griddles (ribbed upper plate)							
MODEL	PRICE £	PRICE €	H	W	D	POWER	WT
*OE8211/R	£9215	€10,598	542	400	800	8.6kW	94
*OE8210/R	£14,500	€16,675	542	800	800	17.2kW	167

Electric clam griddles (1 x flat and 1 x ribbed upper plate)							
MODEL	PRICE £	PRICE €	H	W	D	POWER	WT
*OE8210/FR	£14,558	€16,742	542	800	800	17.2kW	170

MODEL	PRICE £	PRICE €	DESCRIPTION
A OA8960	£59	€68	Plate height adjuster (per plate)
A TFS01	£33	€38	Teflon sheet top plate
S TFS02	£22	€26	Teflon sheet hangers (1 pair)
S TFS03	£32	€37	Teflon sheet base plate 800mm wide (1 sheet)
S TFS04	£19	€22	Teflon sheet base plate 400mm wide (1 sheet)
A OA8971	£738	€849	Pedestal with doors for OE8211
A OA8921	£738	€849	Floor stand for OE8211
A OA8974	£827	€952	Pedestal with doors for OE8210
A OA8974/C	£827	€952	Pedestal with doors and castors for OE8210
A OA8956	£827	€952	Floor stand for OE8210
A OA8956/C	£827	€952	Floor stand with castors for OE8210
A OA8988	£76	€88	Clam adjustment bars 17mm

* Please refer to pages L90 to L91 for electricity supply requirements

Opus 800

All gas power ratings are nominal values. Gas counter top equipment is supplied on 150mm high legs in compliance with CE legislation. Electric counter top equipment is supplied on height adjustable 55-70mm high legs.

Gas Chargrills

- Powerful, highly efficient infra-red ceramic plaque burners for fast cooking and significant energy efficiency
- Independently controlled multiple heat zones (3 in OG8401, 5 in OG8402, 7 in OG8403) for maximum versatility
- Flame failure protection
- Heavy-duty cast iron branding grids with reversible design, for uninterrupted cooking and self cleaning at maximum power
- Unique design of radiants, deliver the ideal amount of flaring for that delicious chargrilled taste, without the mess of lava rock or charcoal
- Heavy duty radiant caps (consumable items) protect burners

Inclusive Accessories

- Branding grid scraper
- Cleaning spatula



Gas chargrill (600mm wide)							
MODEL	PRICE £	PRICE €	H	W	D	POWER	WT
OG8401/N	£4360	€5014	653	600	806	13.8kW	92
OG8401/P	£4360	€5014	653	600	806	12.6kW	92

Gas chargrill (900mm wide)							
MODEL	PRICE £	PRICE €	H	W	D	POWER	WT
OG8402/N	£5651	€6499	653	900	806	23kW	133
OG8402/P	£5651	€6499	653	900	806	23kW	133

Gas chargrill (1200mm wide)							
MODEL	PRICE £	PRICE €	H	W	D	POWER	WT
OG8403/N	£7205	€8286	653	1200	806	32.2kW	173
OG8403/P	£7205	€8286	653	1200	806	29.4kW	173

MODEL	PRICE £	PRICE €	DESCRIPTION
A OA8950	£783	€901	Floor stand for OG8401
A OA8950/C	£783	€901	Floor stand with castors for OG8401
A OA8989	£582	€670	Holding shelf for OG8401

MODEL	PRICE £	PRICE €	DESCRIPTION
A OA8951	£851	€979	Floor stand for OG8402
A OA8951/C	£851	€979	Floor stand with castors for OG8402
A OA8990	£783	€901	Holding shelf for OG8402

MODEL	PRICE £	PRICE €	DESCRIPTION
A OA8952	£1029	€1184	Floor stand for OG8403
A OA8989	£582	€670	Holding shelf for OG8403

SYNERGY™ grill technology

Lincat is delighted to be able to offer the revolutionary Synergy Grill technology as a suited solution within our Opus 800 Series.

Pioneering, award-winning technology Synergy Grill has revolutionised the catering industry. Combining **high power with low energy consumption**, Synergy Grills enable you to **prepare food faster at less than half the energy costs**. Fat atomising technology means there's no fat tray to clean and best of all, it creates seriously succulent food.

- Award winning Synergy Grill technology in an Opus 800 series chassis
- Suites with equipment in the Opus 800 series
- Patented award-winning Synergy Grill technology designed around its gas burner system, working at incredibly hot temperatures yet uses an average of 59% less gas than a standard grill
- Gently smokes the food giving you incredible flavour whilst giving clear contrasting bar-marks
- Quickest grill on the market to clean, the fat is atomised on ceramic base plates, once cold, you can simply vacuum out the dust that's left
- No fat means no fat tray to clean, fat atomising technology means there's no fat tray to clean and best of all, it creates seriously succulent food
- The simplest grill on the market to operate, with no thermocouples to replace and operated by a simple rocker switch
- Safety is paramount, one of the safest units to operate



Synergy Grill							
MODEL	PRICE £	PRICE €	H	W	D	POWER	WT
OG8410/N	£7400	€8510	900	600	800	5.7kW	106
OG8410/P	£7400	€8510	900	600	800	5.7kW	106
OG8411/N	£10,100	€11,615	900	900	800	11.4kW	151
OG8411/P	£10,100	€11,615	900	900	800	11.4kW	151

MODEL	PRICE £	PRICE €	DESCRIPTION
A OA8991	£783	€901	Floor Stand for OG8410
A OA8991/C	£783	€901	Floor Stand for OG8410
A OA8992	£851	€979	Floor Stand for OG8411
A OA8992/C	£851	€979	Floor Stand for OG8411

Product Codes

/N = natural gas /P = propane gas Btu/hr = kW x 3412

Price includes grill on 150mm legs, slow cook shelf, resting shelf and garnish rail

* Please refer to pages L90 to L91 for electricity supply requirements

Electric counter top equipment is supplied on height adjustable 55-70mm high legs.

Electric Chargrills

- Removable, durable, segmented cast iron grids impart attractive branding marks to food
- Independently controlled multiple heat zones (3 in OE8405, and 6 in OE8406) for maximum versatility • Controlled flaring gives that distinctive chargrilled flavour
- Hinging, interlocked elements and integral water bath makes cleaning easier
- Water bath provides humidity, keeping food succulent and reducing shrinkage

- Plumbed to water supply for quick and easy filling of water bath with alternative manual-fill facility
- High temperature safety cut-out for protection if water bath runs dry

Inclusive Accessories

- Grid cleaning tool
- Branding iron lifting rod



Electric chargrill (600mm wide)							
MODEL	PRICE £	PRICE €	H	W	D	POWER	WT
*OE8405	£3611	€4153	415	600	817	8.4kW	69

Electric chargrill (900mm wide)							
MODEL	PRICE £	PRICE €	H	W	D	POWER	WT
*OE8406	£4964	€5709	415	900	817	12.4kW	73

MODEL	PRICE £	PRICE €	DESCRIPTION
A OA8972	£783	€901	Pedestal with doors
A OA8972/C	£783	€901	Pedestal with doors and castors
A OA8917	£783	€901	Floor stand
A OA8917/C	£783	€901	Floor stand with castors
A OA8986	£713	€820	Keep warm shelf
A OA8987	£187	€216	Condiment holder
A OA8959	£78	€90	Tool holder accessory

MODEL	PRICE £	PRICE €	DESCRIPTION
A OA8973	£851	€979	Pedestal with doors
A OA8973/C	£851	€979	Pedestal with doors and castors
A OA8914	£851	€979	Floor stand
A OA8914/C	£851	€979	Floor stand with castors
A OA8959	£78	€90	Tool holder accessory
			Suitable accessory for all Opus 800 products

Electric Direct Cook Chargrills

- Create perfectly cooked, expertly branded burgers and steaks
- As food is cooked directly on the elements, there's no need for separate branding bars or grids
- Powerful elements are designed for rapid heat-up and a consistent temperature across the whole cooking surface
- Independently-controlled elements on the OE8414 mean one side can be switched off during quieter service periods to save energy

- After service, the unit can be turned on full power for 15 minutes to burn off fat and debris. After this, any remaining debris can be removed using the tool supplied
- Fully removable tank liner for easy cleaning.



Electric chargrill (600mm wide)							
MODEL	PRICE £	PRICE €	H	W	D	POWER	WT
*OE8413	£4530	€5210	592	600	800	8.4kW	69

Electric chargrill (600mm wide)							
MODEL	PRICE £	PRICE €	H	W	D	POWER	WT
*OE8414	£6356	€7310	592	900	800	13.4kW	90

MODEL	PRICE £	PRICE €	DESCRIPTION
A OA9010	£783	€901	Floor stand
A OAOA9010/C	£783	€901	Floor stand with castors
A OA8989	£582	€670	Keep warm shelf
A OA9002	£255	€294	Condiment holder
A OA9008	£11	€13	Scraper

MODEL	PRICE £	PRICE €	DESCRIPTION
A OA9011	£773	€889	Floor stand
A OA9011/C	£773	€889	Floor stand with castors
A OA8990	£783	€901	Keep warm shelf
A OA9003	£271	€312	Condiment holder
A OA9008	£11	€13	Scraper

* Please refer to pages L90 to L91 for electricity supply requirements

Opus 800

All gas power ratings are nominal values.

Electric Pasta Boiler

- Two position water setting: fast fill, or trickle fill for maintaining water level while cooking
- Boil dry protection
- Starch removal system keeps water fresh
- Direct overflow connection and water replenishment
- Direct connection to water supply and waste
- Units are supplied without pasta baskets, choice of optional high quality pasta baskets for convenience and flexibility
- Can be used as a pasta boiler, steamer or bain marie, saving valuable space
- For safety and stability this product is supplied with front legs and rear castors



2

YEAR

UK parts
and labour
warranty

Export
parts
warranty

on all Lincat
products

Electric pasta boiler						
MODEL	PRICE £	PRICE €	H	W	D	POWER WT
*OE8701	£3981	€4579	1020	400	800	6kW 67

Price does not include basket

Pasta baskets

MODEL	PRICE £	PRICE €	DESCRIPTION	NO. REQUIRED
A OA8922	£259	€298	Large pasta basket	1
A OA8924	£189	€218	Half pasta basket	2
A OA8925	£140	€161	Quarter pasta basket	4

Gastronorm containers (150mm deep) and lids for operation as a bain marie

MODEL	PRICE £	PRICE €	DESCRIPTION	NO. REQUIRED
A OA8926	£242	€279	GN 1/1 container	1
A OA8927	£147	€170	GN 1/2 container	2
A OA8928	£148	€171	GN 1/3 container	3

Perforated gastronorm containers (140mm deep) and lids for operation as a steamer

MODEL	PRICE £	PRICE €	DESCRIPTION	NO. REQUIRED
A OA8931	£297	€342	GN 1/1 perforated container	1
A OA8932	£204	€235	GN 1/2 perforated container	2

Opus 800

Electric counter top equipment is supplied on height adjustable 55-70mm high legs.

Electric Bain Marie

- Compatible with standard GN 1/1 containers
- Optional gastronorm packs enable you to tailor the unit to your requirements
- Robust front mounted tap for easy drainage
- Unique, easy-to-clean flush fitting plate element
- Boil dry protection feature prevents element from overheating and failing
- Accurate thermostatic control maintains food at a constant safe temperature



Electric bain marie							
MODEL	PRICE £	PRICE €	H	W	D	POWER	WT
OE8601	£1725	€1984	300	400	800	1.8kW	25

MODEL	PRICE £	PRICE €	DESCRIPTION
A OA8926	£242	€279	GN 1/1 container (150mm deep) and lids (1 required)
A OA8927	£147	€170	GN 1/2 container (150mm deep) and lids (2 required)
A OA8928	£148	€171	GN 1/3 container (150mm deep) and lids (3 required)
A OA8971	£738	€849	Pedestal with doors
A OA8921	£738	€849	Floor stand
A LK11	£61	€71	Long leg kit

Electric Chip Scuttle

- Heated from above and below to keep chips and other deep-fried products in perfect condition
- Removable perforated fat drain plate helps to keep deep-fried products fresh and crisp
- Overhead heat lamp enhances presentation with an attractive warm glow
- Removable chip container is quick and easy to clean

Inclusive Accessories

- 1/1 GN container with perforated fat drain plate



Electric chip scuttle							
MODEL	PRICE £	PRICE €	H	W	D	POWER	WT
OE8109	£1929	€2219	825	400	800	1.5kW	48

MODEL	PRICE £	PRICE €	DESCRIPTION
A OA8971	£738	€849	Pedestal with doors
A OA8921	£738	€849	Floor stand
A LK11	£61	€71	Long leg kit

Worktops

- Provides useful workspace
- Designed to suite with Opus 800 equipment
- Can be mounted on a floor stand or pedestal with doors



Worktops							
MODEL	PRICE £	PRICE €	H	W	D	WT	
OA8919	£687	€791	300	300	800	17	
OA8938	£721	€830	300	400	800	22	
OA8936	£735	€846	300	600	800	26	
OA8939	£764	€879	300	800	800	33	
OA8940	£788	€907	300	900	800	36	

* Please refer to pages L90 to L91 for electricity supply requirements

Opus 800

Electric counter top equipment is supplied on height adjustable 55-70mm high legs.

Pedestals with Doors and Floor Stands

Pedestals with doors

- Suitable for Opus 800 series counter top models**
- 300mm, 400mm, 600mm, 800mm and 900mm widths available
- Cupboard with side hinged doors

2
YEAR

UK parts
and labour
warranty

Export
parts
warranty

on all Lincat products

Floor stands

- Suitable for Opus 800 series counter top models**
- 300mm, 400mm, 600mm, 800mm and 900mm widths available



Also available with castors



Pedestals

MODEL	PRICE £	PRICE €	DESCRIPTION
A OA8970	£711	€818	Pedestal with doors for units 300mm wide
A OA8971	£738	€849	Pedestal with doors for units 400mm wide
A OA8972	£783	€901	Pedestal with doors for units 600mm wide
A OA8972/C	£783	€901	Pedestal with doors and castors for units 600mm wide
A OA8974	£827	€952	Pedestal with doors for units 800mm wide
A OA8974/C	£827	€952	Pedestal with doors and castors for units 800mm wide
A OA8973	£851	€979	Pedestal with doors for units 900mm wide
A OA8973/C	£851	€979	Pedestal with doors and castors for units 900mm wide

Floor stands

MODEL	PRICE £	PRICE €	DESCRIPTION
A OA8934	£711	€818	Floor stand for units 300mm wide
A OA8921	£738	€849	Floor stand for units 400mm wide
A OA8917	£783	€901	Floor stand for units 600mm wide
A OA8917/C	£783	€901	Floor stand with castors for units 600mm wide
A OA8956	£827	€952	Floor stand for units 800mm wide
A OA8956/C	£827	€952	Floor stand with castors for units 800mm wide
A OA8914	£851	€979	Floor stand for units 900mm wide
A OA8914/C	£851	€979	Floor stand with castors for units 900mm wide

CONVECTOR



Convactor Convection Oven: fast, efficient and effective

Able to roast, braise, bake and reheat, a Convactor convection oven is a powerful addition to any commercial kitchen. Ideal for roasts, casseroles, bread, cakes and pastry, it can produce supremely even results even when fully loaded, thanks to its bi-directional, two-speed fan and optimised airflow.

With a range of sizes and power ratings to suit any application, Convactor provides the capacity, control and power you need.

Ideally suited for...

A modern, smart design that looks great both front of house and in the kitchen, with a range of sizes and power ratings to suit any application. Places such as:



Bakeries

Whether you're starting from scratch, or from par-baked or pre-proved products, produce uniform results, even when full, so all of your bakes look the same every time.



Restaurants

Convactor is a great choice for roasting and braising, with two speed fan perfect for switching to slow speed, to tenderise meat at the end of the cooking cycle.



Pubs

The Convactor range is able to roast, braise, bake and reheat. Ideal for when you need consistently even results from a fully loaded oven.

Benefits at a glance

- Uniform results, every time, even when full
- Two-speed bi-directional fan
- Oven cavity optimised for airflow
- Flashing oven lamps when cook cycle ends
- Roast, braise, bake and reheat
- Manual+ and Touch models available
- Intuitive easy to use controls

Putting you in control for perfect results every time

Convect convection ovens put you in control. They give you the power to produce perfect results every time, with two control panel options, **Manual+** and **Touch**.



Manual+ provides the best of both worlds, the simplicity of mechanical temperature control and the cooking benefits afforded by two-speed electronic fan control.

Even in the busiest, noisiest kitchen the Convector's electronically controlled buzzer and flashing oven lamps will ensure that you hear and see that it has reached the end of its cooking cycle.

Touch control's 4.3" touchscreen menu is intuitive and provides the wider functionality and greater control that only a touchscreen can deliver. Cook programs are easy to set up and simple to use. Up to four stages can be created with an icon assigned to each of the 24 programs.



MANUAL+ CONTROL

Easy-to-use knob-driven control, mechanical temperature control, electronic fan control.



TEMPERATURE CONTROL

Mechanical thermostat 60°C to 260°C.

COUNT DOWN TIMER

120-minute timer with electronically-controlled buzzer. Oven lamps flash when the cook cycle has finished until the door is opened.

EVEN HEAT DISTRIBUTION

Electronically controlled two-speed, bi-directional fan.

TWO FAN SPEEDS

Standard for general use and slow for delicate items such as meringue, choux pastry, flans and quiches.

TOUCH CONTROL

Touchscreen control with easy-to-use icon-driven menu selections.



EASY-VIEW TRAFFIC LIGHT STATUS

Great for busy and noisy kitchens, ColourCue shows you the status of the oven at a glance: red - action is required such as unload; amber - the oven is pre heating or cooking; green - the oven is ready.

PHASED COOKING

Four-stage cooking for perfect results - set temperature, time, fan speed and humidity injection for each stage.

PROGRAM MODE

24 programs with up to four stages, which you can adjust individually. Icons and names can be assigned to each program to make it even easier to use, especially for untrained staff.

MANUAL MODE

Simple and easy to set the time and temperature required, then manually control humidity injection and fan speed during the cook cycle.

SHELF TIMER MODE

Four individual nine-hour timers allow you to track different products in program and manual mode.

TEMPERATURE CONTROL

Precise electronic temperature control from 30°C to 260°C.

COUNT DOWN TIMER

Nine-hour on-screen timer. An electronic buzzer sounds and the oven lamps flash when the cook cycle has finished until the door is opened or the alert is cancelled on the touchscreen.

HUMIDITY LEVELS

Five levels of humidity injection on C0100 and C0200 models

EVEN HEAT DISTRIBUTION

Electronically controlled two-speed, bi-directional fan.

TWO FAN SPEEDS

Standard for general use and slow for delicate items such as meringue or choux pastry.

USB

USB port for copying programs, ideal for operations with multiple sites. Future updates can also be easily managed.

The Range

We offer a range of convection ovens to suit any application and provide the capacity, control and power you need.



Model	C0133M	C0133T	C0223M	C0223T
List Price	£2418 / €2781	£3202 / €3683	£2677 / €3079	£3553 / €4086
GN Capacity	3 x GN2/3	3 x GN2/3	2 x GN1/1	2 x GN1/1
Sheet Capacity	400 x 300 Baking Sheets 460 x 330 Baking Sheets	400 x 300 Baking Sheets 460 x 330 Baking Sheets	600 x 400 Baking Sheets 660 x 460 Baking Sheets	600 x 400 Baking Sheets 660 x 460 Baking Sheets
Capacity Litres	53	53	96	96
Height (External) mm	645	645	645	645
Width (External) mm	610	610	810	810
Depth (External) mm	750	750	850	850
Height (Internal) mm	308	308	308	308
Width (Internal) mm	490	490	690	690
Depth (Internal) mm	370	370	470	470
Oven Rating kW	2.8	2.8	2.8	2.8
Weight kg	71	72	91	92

Accessories

	C0100/FS	C0100/FS	C0200/FS	C0200/FS
Floor stand 6 runners	C0100/FS	C0100/FS	C0200/FS	C0200/FS
List Price	£1019 / €1172	£1019 / €1172	£1019 / €1172	£1019 / €1172
Low floor stand and stacking kit	C0100/LFSK	C0100/LFSK	C0200/LFSK	C0200/LFSK
List Price	£1019 / €1172	£1019 / €1172	£1019 / €1172	£1019 / €1172

Water Treatment Units

It is recommended that a water treatment unit is installed with all Convector Touch models.

A water treatment unit will filter chemicals from the incoming water, including calcium helping to prevent the build up of limescale within the unit and ensuring steam is generated from purified water.

MODEL	PRICE £	PRICE €	DESCRIPTION
A ACIK04	£292	€336	Filter Kit
C FC23	£144.85	€166.60	Filter Cartridge





CO235M	CO235T	CO343M	CO343T
£2852 / €3280	£3726 / €4285	£2443 / €2810	£2730 / €3140
3 x GN1/1	3 x GN1/1	4 x GN1/1	4 x GN1/1
600 x 400 Baking Sheets 660 x 460 Baking Sheets	600 x 400 Baking Sheets 660 x 460 Baking Sheets	400 x 300 Baking Sheets 460 x 330 Baking Sheets	400 x 300 Baking Sheets 460 x 330 Baking Sheets
96	96	72	72
645	645	600	600
810	810	660	660
850	850	740	740
308	308	398	398
690	690	330	330
470	470	550	550
4.6	4.6	2.8	2.8
93	94	84	84

CO200/FS	CO200/FS	CO300/FS	CO300/FS
£1019 / €1172	£1019 / €1172	£1019 / €1172	£1019 / €1172
CO200/LFSK	CO200/LFSK	CO300/LFSK	CO300/LFSK
£1019 / €1172	£1019 / €1172	£1019 / €1172	£1019 / €1172



2 YEAR
UK parts and labour warranty
Export parts warranty
on all Lincat products

* Please refer to pages L90 to L91 for electricity supply requirements

Technical Details and Accessories

Convector convection ovens have a modern, smart design that looks great both front of house and in the kitchen. However, it is the detail which makes all the difference, together with ease of use and the quality and consistency of the food it can produce.

1 OPTIMISED OVEN CAVITY

The optimised geometry of the oven cavity and side deflectors ensure that airflow is optimised across the shelves.

2 TWO SPEED, BI-DIRECTIONAL FAN SYSTEM

The powerful 190mm diameter bi-directional stainless-steel fan ensures that heat is distributed evenly throughout the cabinet, to deliver consistent results even with full loads. The standard fan speed is ideal for general use, the slow for delicate items such as meringue, choux pastry, flans and quiches.

3 DOUBLE GLASS DOOR

Double glass doors ensure that the outer door stays cool and is safe to touch. The inner glass is easily removable for cleaning, so you can always have a clear view of what's cooking.

4 OVEN CONSTRUCTION

100% stainless steel construction. The oven cabinets of Touch models, which are equipped with five levels of humidity injection, are constructed from 304-grade stainless steel for durability.

5 OVEN CABINET SEAL

The new plug-in continuous door seal is robust and seamless, which makes cleaning and replacement quick and easy without the need for tools.

6 RACKING SYSTEM

Oven racks are anti-tilt. Easy-to-release screws allow the side racks to be removed quickly for cleaning.

7 TRAY SPACING

Optimised tray spacing provides the flexibility required to use baking sheets or gastronorm dishes.

8 HALOGEN LAMPS

Offset lamp heights and energy efficient, brighter white light dual halogen lamps provide optimum illumination for both the cabinet and each individual shelf. Perfect for busy, noisy kitchens, the halogen lamps flash when the cook cycle has finished and continue to do so until the door is opened.

9 COMPACT FOOTPRINT

The Convector series has been designed to take up the minimum of counter or floor space, whilst still taking standard sizes of gastronorm dishes and euro baking sheets.

10 STACKING KIT

In kitchens where space is at a premium, two Convector ovens can be stacked, one on top of the other, using a stacking kit. This not only increases output potential but also provides the flexibility to cook products which require different temperatures, times or humidity.

11 STANDS

Stands are made from high-quality, stainless steel and provide robust, secure support for your Convector oven.

12 NON-SLIP FEET

Non-slip feet not only ensure that the oven stays in position and resists movement, but also reduce noise and vibration during operation.

blu^o

KEEPING IT COOL

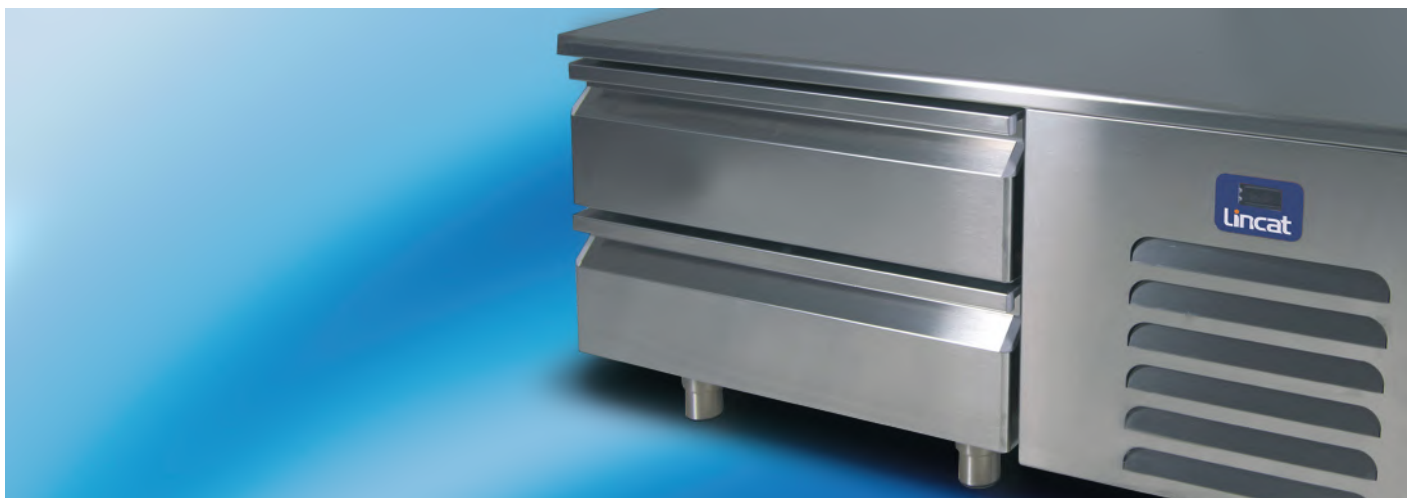

In busy kitchens where speed is crucial, caterers need quick and easy access to food at the point of cooking, Blu° refrigerated chef bases provide the ideal solution.

Our Blu° chef bases, brought to you in conjunction with our market leading sister company Desmon, Blu° bases allow easy access to stored, chilled food at the point of cooking.

Designed to accommodate heavy-duty Opus 800 series equipment such as chargrills, griddles and induction hobs, the unit has self-closing, heavy-duty drawers capable of holding 1/1 GN 100mm-deep containers, providing convenient bulk storage for meat and fish.

The Blu° chef bases are powered by a three-pin plug, therefore requiring no installation. For ease of cleaning, the units have removable drawers, rounded interior corners and removable rubber magnetic door gaskets. They are supplied on castors, making it simple to pull the unit out for a deep clean. As with all Lincat products, the Blu° chef bases come with a two-year warranty.

Ideally suited for...

Blu° chef bases are perfect for the most demanding of kitchens allowing easy access to stored, chilled food at the point of cooking.



Large chain pubs and restaurants

Is your kitchen constantly under pressure to deliver delicious dishes at high volumes? If so, you'll find Blu° chef bases speed up operations.



High Volume Kitchens

If you need to cook a vast quantity of meals, Blu° chef bases will improve the efficiency in your kitchen.

Benefits at a glance

- Designed to accommodate heavy equipment, including Opus 800 Series chargrills, griddles and hobs
- Drawers hold 1/1 GN 100mm deep containers
- Allows bulk storage and easy access to food at point of cooking
- Ideal for meat and fish
- Adjustable thermostat -2° to +8°C
- Self-closing heavy duty drawers
- Supplied on castors as standard

Chef Bases

- Three widths available – 800mm, 900mm and 1200mm
- Designed to accommodate heavy equipment including Opus 800 Series chargrills, griddles and hobs
- Drawers hold 1/1 GN 100mm deep container/s
- Allows bulk storage and easy access to food at point of cooking
- Ideal for meat and fish
- Adjustable digital thermostat -2°C to +8°C
- Self-closing heavy duty drawers
- Energy grade D
- Supplied on castors as standard



 Chef bases									
MODEL	PRICE £	PRICE €	H	W	D	NO. OF DRAWERS	1/1GN CAPACITY	POWER	WT
BD20032	£4280	€4922	615	838	826	2	2	0.6kW	140
BD20036	£4452	€5120	614	916	826	2	2	0.6kW	144
BD20048	£5069	€5830	614	1220	826	2	4	0.6kW	174





Phoenix offers performance and power without the frills, at a cost-effective price point

Robust and durable, the medium duty Phoenix series includes both gas and electric models, and has been designed to cope with the day-to-day demands of the busiest of kitchens.

The series is ideal for the value-conscious buyer who doesn't want to sacrifice quality and performance.

Ideally suited for...

The Phoenix series is ideal for anyone who needs power which packs a punch, while keeping costs to a minimum. They include:



Care homes

The Phoenix series comes with the power and capacity to deliver quality meals at set times in a care home environment.



Schools

Looking for a cost-effective solution for delivering high-volume school meals? The Phoenix series provides just that, with the perfect combination of power and performance.



Smaller pubs and restaurants

Robust enough to cope in busy kitchens, the Phoenix series will keep up with the demands that you place on it.

The Phoenix series provides power and performance without having to break the bank.

Benefits at a glance

- Medium duty
- Cost-effective
- Robust
- Performance guaranteed
- Powerful
- Gas and electric models
- Easy to clean



Bratt Pans

Turn up the volume! Solve bulk cooking needs even at high temperatures. Perfect for bulk cooking in a variety of methods - allows users to braise, shallow fry or boil a variety of food products in large quantities.

Gas Bratt Pan



- Large 80 litre capacity
- Temperature control flexible from 45°C to 295°C - maximum flexibility to meet different cooking needs
- Handwheel controlled manual tilting for a smooth tilt
- Large pouring spout for easy emptying of the pan, reducing mess
- Incoloy alloy corrosion resistant elements
- AISI 304 grade stainless steel for uniform heat distribution, perfect for high temperature cooking
- Robust 12mm thick base
- Easy clean stainless steel design
- Also supplied with LPG jets for conversion on site

Gas Bratt Pan							
MODEL	PRICE £	PRICE €	H	W	D	POWER	WT
PHGBP80/N	£8294	€9539	970	800	900	20kW	180

MODEL	PRICE £	PRICE €	DESCRIPTION
A CA01	£647	€745	Control Kit (4)

2
YEAR

 UK parts
and labour
warranty

 Export
parts
warranty

on all Lincat products

Electric Bratt Pan

- Large 80 litre capacity
- Temperature control flexible from 45°C to 295°C - maximum flexibility to meet different cooking needs
- Handwheel controlled manual tilting for a smooth tilt
- Large pouring spout for easy emptying of the pan, reducing mess
- High thermal efficiency stainless steel tubular burners
- AISI 304 grade stainless steel for uniform heat distribution, perfect for high temperature cooking
- Robust 12mm thick base
- Easy clean stainless steel design



Electric Bratt Pan							
MODEL	PRICE £	PRICE €	H	W	D	POWER	WT
PHEBP80	£8743	€10,055	970	800	900	10kW	180

MODEL	PRICE £	PRICE €	DESCRIPTION
A CA01	£647	€745	Control Kit (4)

‡ Zones can be boosted to 3kW for up to 10 minutes while the others will be reduced.
 †/On PHER01/SPH - 6 x 1.5kW zones and 4kW oven

Gas Oven Range

- High quality, excellent performance, value for money
- Powerful 6kW burners - the pan will heat up quicker, speeding up processes such as boiling and sautéing, achieving a caramelised colour faster
- Fully pressed hob - simpler and quicker to clean
- Twin heavy-duty cast iron supports, built to withstand the rigours of the busiest kitchen
- Low flue, hob top accommodates larger pans
- Flame failure protection
- Powerful 10kW oven - the oven will heat up faster and recover more quickly when loaded
- Large 4 x GN1/1 capacity oven enabling four different foods to be cooked simultaneously
- 2 shelves and 5 shelf positions maximise oven space
- Piezo ignition to oven for simple operation

- Double insulated doors and side panels for safe operation, efficiency and economy
- Robust and durable stainless steel design
- Castors supplied as standard, not as a chargeable extra



6 burner gas oven range							
MODEL	PRICE £	PRICE €	H	W	D	POWER	WT
PHGR01/N	£2768	€3184	900	900	800	46kW	145
PHGR01/P	£2768	€3184	900	900	800	45.5kW	145
Internal usable dimensions			405	715	540		

MODEL	PRICE £	PRICE €	DESCRIPTION
A OA8902	£554	€638	Splashback/shelf

Dual Fuel Oven Range

- High quality, excellent performance, value for money
- Powerful 6kW burners - the pan will heat up quicker, speeding up processes such as boiling and sautéing, achieving a caramelised colour faster
- Fully pressed hob - simpler and quicker to clean
- Twin heavy-duty cast iron supports, built to withstand the rigours of the busiest kitchen
- Low flue, hob top accommodates larger pans

- Flame failure protection
- Powerful 6kW twin fan assisted oven for more even cooking
- Large 4 x GN1/1 capacity oven enabling four different foods to be cooked simultaneously
- 2 shelves and 5 shelf positions maximise oven space
- Double insulated doors and side panels for safe operation, efficiency and economy
- Robust and durable stainless steel design
- Castors supplied as standard, not as a chargeable extra



6 burner dual fuel oven range							
MODEL	PRICE £	PRICE €	H	W	D	POWER	WT
*PHDR01/N	£5055	£5814	900	900	800	45kW	145
*PHDR01/P	£5055	£5814	900	900	800	40.2kW	145
Internal usable dimensions			400	715	530		

MODEL	PRICE £	PRICE €	DESCRIPTION
A OA8902	£554	€638	Splashback/shelf

2
YEAR

 UK parts
and labour
warranty

 Export
parts
warranty

on all Lincat products

Induction Oven Ranges

- High quality, excellent performance, value for money
- Six 1.85kW zones (PHER01), four 1.85kW zones (PHER02). When you need intense heat to get you cooking fast zones can be boosted to 3kW for up to 10 minutes. Power to the other zones will drop during the boost period
- Incredible efficiency, automatically cutting power when no pan is present, reducing running costs and providing a more comfortable kitchen environment
- Easy to clean, heavy duty 6mm thick high impact resistant glass ceramic surface
- Large 6 x GN1/1 capacity (PHER01), 3 x GN1/1 capacity (PHER02) oven capacity enabling different foods to be cooked simultaneously
- Powerful 6kW twin fan assisted oven (PHER01) and 3kW single fan assisted oven (PHER02) for even cooking
- Highly insulated oven reducing heat loss and ensuring a more consistent temperature
- Robust and durable stainless steel design
- PHER01 available in single or three phase
- Heavy duty castors supplied as standard, not as a chargeable extra



4 zone induction oven range								
MODEL	PRICE £	PRICE €	H	W	D	PHASE	POWER	WT
*PHER02	£5702	€6558	900	600	805	1 or 3	11.4kW	103
Internal usable dimensions			405	495	530			



6 zone induction oven range								
MODEL	PRICE £	PRICE €	H	W	D	PHASE	POWER	WT
*PHER01	£8101	€9317	923	900	817	3	17.1kW	145
*PHER01/SPH	£8101	€9317	923	900	817	1	13kW	145
Internal usable dimensions			440	725	512			



Counter Top Induction Hob

NEW!

- For where you need power in a small footprint
- Compact sleek design
- Two cooking zones
- High efficiency - delivers almost twice the cooking power of a similarly rated gas hob
- Functional and attractive profile, perfect for front of house theatre-style cooking
- When you need intense heat to get you cooking fast, zones can be boosted to 3kW for up to 10 minutes. Power to other zones will drop during the boost period
- Easy to clean, heavy duty 6mm thick high impact resistant glass



Counter Top Induction Hob							
MODEL	PRICE £	PRICE €	H	W	D	POWER	WT
*PHEH01	£2413	€2775	146	350	705	3.7kW	12

Electric Adjustable Salamander Grill

- Fast heat up 'Hi-Light' elements - ready to cook in just 8 seconds
- Height adjustable grill hood reduces heat loss to surrounding area
- Three cook zones - only turn on the area you need
- Energy saving
- GN 1/1 compatible
- 15 minute timer



Electric Salamander Grill							
MODEL	PRICE £	PRICE €	H	W	D	POWER	WT
*PHEAS01	£3648	€4196	544	600	545	4.5kW	69

MODEL	PRICE £	PRICE €	DESCRIPTION
A BR75	£255	€294	Wall bracket

* Please refer to pages L90 to L91 for electricity supply requirements

SILVERLINK 600



Configure your cooking space with the custom-build Silverlink 600 range

The Silverlink 600 series of 600mm deep modular cooking equipment is designed for flexibility, enabling you to configure your cooking space just the way you like it.

The range includes countertop, base units, and freestanding versions of a wide variety of kitchen equipment, including oven ranges, boiling tops, ovens, pasta boilers, bain maries, fryers, chip scuttles, grills and griddles

The medium-duty Silverlink 600 range is perfect for shift service output, such as those establishments serving lunch and dinner.

Ideally suited for...

The Silverlink 600 series is suitable for a variety of locations where flexibility is appreciated, including the following:



Care homes

The medium-duty series is aimed at locations with shift service output. This makes it perfect for care homes with set meal patterns.



Larger café bars

With every piece of equipment you could hope to find in a kitchen, your café bar will be able to provide a range of delicious dishes.



Village halls and community centres

Make the most of the modular flexibility to configure your food preparation area your way.



Small to medium pubs and restaurants

Ideal for pubs and restaurants with shift service operations looking for flexible solutions in their kitchen.

Modular cooking equipment designed for flexibility, enabling you to configure your cooking space just the way you like it.

Benefits at a glance

- 600mm deep
- Medium duty
- Modular flexibility
- Free standing and counter top units
- Ideal for establishments serving on a shift basis (lunch and dinner)
- Gas and electric models
- Easy to clean

SILVERLINK 600

All gas power ratings are nominal values. All Silverlink 600 counter top units when mounted on optional floor stands or pedestals provide a uniform nominal hob height of 900mm.

Gas Oven Ranges

- Fully pressed and sealed hob tops for easy cleaning
- Robust, easy-clean vitreous enamelled cast iron pan supports
- Low level flue maximises working area and enables you to use large stock pots
- Large capacity oven with a stainless steel interior for easy cleaning
- Oven and hob burners with automatic flame failure device for added safety



4 burner gas range (legs at rear)								
MODEL	PRICE £	PRICE €	H	W	D	POWER	WT	
SLR6/N	£2789	€3208	935	956	600	600	23.8kW	80
SLR6/P	£2789	€3208	935	956	600	600	23.8kW	80
Internal usable dimensions			400	485	342			

6 burner gas range (legs at rear)								
MODEL	PRICE £	PRICE €	H	W	D	POWER	WT	
SLR9/N	£3233	€3718	935	956	900	600	35.5kW	106
SLR9/P	£3233	€3718	935	956	900	600	35.5kW	106
Internal usable dimensions			400	725	342			

4 burner gas range (castors at rear)								
MODEL	PRICE £	PRICE €	H	W	D	POWER	WT	
SLR6C/N	£2789	€3208	956	600	600	23.8kW	80	
SLR6C/P	£2789	€3208	956	600	600	23.8kW	80	
Internal usable dimensions			360	480	342			

6 burner gas range (castors at rear)								
MODEL	PRICE £	PRICE €	H	W	D	POWER	WT	
SLR9C/N	£3233	€3718	956	900	600	35.5kW	106	
SLR9C/P	£3233	€3718	956	900	600	35.5kW	106	
Internal usable dimensions			400	725	342			

Splashback and plate shelf

MODEL	PRICE £	PRICE €	DESCRIPTION	H
A SLR6/SB	£298	€343	For model SLR6	450

Splashbacks should not be used when ranges are fitted with castors

Splashback and plate shelf

MODEL	PRICE £	PRICE €	DESCRIPTION	H
A SLR9/SB	£314	€362	For model SLR9	450

Splashbacks should not be used when ranges are fitted with castors

Electric Oven Range

- Compact 600mm deep footprint - perfect for care homes as well as smaller pubs and restaurants
- Six hotplates 3 x 2.0kW, 3 x 1.5kW (ESLR9C), four hotplates 2 x 2.0kW, 2 x 1.5kW (ESLR6C) with six-position control knob for each plate - higher power for sautéing at the front, lower power to the rear ideal for simmering
- Automatic power reduction, if the pan boils dry or is removed, prolonging hotplate life
- Easy clean fully pressed and sealed hob
- Powerful 6kW twin assisted oven (ESLR9C) and 4kW fan assisted oven (ESLR6C, ESLR9C/SPH) for uniform heat distribution and consistent cooking
- To suit install requirements the ESLR6C can be wired as either single or three phase and the ESLR9C is available in single or three phase
- Double insulated doors, side and back panels providing safer operation, greater efficiency and economy
- Castors at rear to enable unit to be pulled out for deeper cleans



4 plate electric range							
MODEL	PRICE £	PRICE €	H	W	D	POWER	WT
*ESLR6C	£2713	€3120	932	600	670	11kW	73

6 plate electric range (castors at rear)								
MODEL	PRICE £	PRICE €	H	W	D	POWER	WT	
*ESLR9C	£3372	€3878	932	900	670	16.5kW	110	
*ESLR9C/SPH	£3372	€3878	932	900	670	13kW	110	
Internal usable dimensions			428	725	342			

670mm deep including fan housing

Key

- H = Height (mm)
- W = Width (mm)
- D = Depth (mm)
- WT = Packed Weight in kg

Electric Ovens

- Stainless steel interior with radiused corners and removable side shelf supports for easy cleaning
- Able to support a suitably sized Silverlink 600 counter-top unit
- Side opening doors, with robust hinges and ball catch, to give safe, easy access
- Fan-assisted models give superior heat distribution with a rapid cool down feature
- Compatible with SLI42



Electric ovens								
MODEL	PRICE £	PRICE €	H	W	D	POWER	WT	
V6	£1705	€1961	650 - 674	600	623	3kW	57	
Internal usable dimensions			420	470	335			
V6/F	£1940	€2231	650 - 674	600	623	3kW	58	
Internal usable dimensions			420	470	335			

V6/F - fan assisted

Electric ovens with glass doors								
MODEL	PRICE £	PRICE €	H	W	D	POWER	WT	
V6/D	£1832	€2107	650 - 674	600	623	3kW	57	
Internal usable dimensions			420	470	335			
V6/F/D	£2102	€2418	650 - 674	600	623	3kW	58	
Internal usable dimensions			420	470	335			

V6/F - fan assisted

Large electric ovens								
MODEL	PRICE £	PRICE €	H	W	D	POWER	WT	
V7	£2316	€2664	650 - 674	750	600	3kW	66	
Internal usable dimensions			430	558	390			
*V7/4	£2424	€2788	650 - 674	750	600	4kW	60	
Internal usable dimensions			430	558	335			

V7 & V7/4 - fan assisted

MODEL	PRICE £	PRICE €	DESCRIPTION
A V6/T	£137	€158	Top for V6 series ovens

See page L56 for stands for V6 and V7 ovens

MODEL	PRICE £	PRICE €	DESCRIPTION
A V7/T	£147	€170	Top for V7 series ovens

* Please refer to pages L90 to L91 for electricity supply requirements

SILVERLINK 600

All gas power ratings are nominal values. All Silverlink 600 counter top units when mounted on optional floor stands or pedestals provide a uniform nominal hob height of 900mm.

Electric Boiling Tops

- Fully pressed and sealed hob tops for easy cleaning
- Automatic power reduction, if pan boils dry or is removed - prolonging hotplate life
- Six-position switches control each plate
- 180mm / 7" sealed hotplates



2 plate boiling top							
MODEL	PRICE £	PRICE €	H	W	D	POWER	WT
HT3	£539	€620	290	300	600	3kW	12

4 plate boiling top							
MODEL	PRICE £	PRICE €	H	W	D	POWER	WT
*HT6	£798	€918	290	600	620	7kW	21

4 plate boiling top							
MODEL	PRICE £	PRICE €	H	W	D	POWER	WT
*HT7	£944	€1086	290	750	620	7kW	23

Gas Boiling Tops

- Powerful gas burners with flame failure device for added safety
- Fully pressed and sealed hob tops for easy cleaning
- Robust, easy-to-clean vitreous enamelled cast iron pan supports
- Low level flue maximises working area and enables you to use large stock pots

Product Codes

/N = natural gas /P = propane gas Btu/hr = kW x 3412



2 burner boiling top							
MODEL	PRICE £	PRICE €	H	W	D	POWER	WT
HT3/N	£1028	€1183	306	300	626	9kW	15
HT3/P	£1028	€1183	306	300	626	9kW	15

4 burner boiling top							
MODEL	PRICE £	PRICE €	H	W	D	POWER	WT
*HT6/N	£1599	€1839	306	600	626	18kW	26
*HT6/P	£1599	€1839	306	600	626	18kW	26

6 burner boiling top							
MODEL	PRICE £	PRICE €	H	W	D	POWER	WT
HT9/N	£2078	€2390	306	900	626	27kW	37
HT9/P	£2078	€2390	306	900	626	27kW	37

Induction Hobs

- High power – almost twice the cooking power of a similarly rated gas hob
- Boost function on multi-zone models delivers power when it's most needed
- 6mm thick high impact resistant glass ceramic surface will withstand hard knocks and is easy to clean
- Suites perfectly with other Silverlink 600 products to create a professional cookline
- Easy to use rotary controls complete with LED display of power level
- Pan detection function cuts power when no pan is present, preventing harm to users and utensils, while saving energy
- Automatic heat up function switches to a preset power level after full power heat up
- Easy to change filter, built into the base of the unit
- Powerful internal cooling fan and overheat protection for long service life
- These units are not suitable for mounting on Silverlink 600 heated pedestals
- Compatible with V6 ovens

2 YEAR UK parts and labour warranty | Export parts warranty
on all Lincat products



1 zone induction hob							
MODEL	PRICE £	PRICE €	H	W	D	POWER	WT
SLI3	£1619	€1862	290	450	600	3kW	22

1 zone induction hob							
MODEL	PRICE £	PRICE €	H	W	D	POWER	WT
SLI3W	£2195	€2525	290	450	600	2.4kW	20

2 zone induction hob							
MODEL	PRICE £	PRICE €	H	W	D	POWER	WT
SLI21	£1568	€1804	290	450	600	3kW	22

4 zone induction hob							
MODEL	PRICE £	PRICE €	H	W	D	POWER	WT
SLI42	£2774	€3191	290	600	600	2 x 3kW	31

SILVERLINK 600

All gas power ratings are nominal values. All Silverlink 600 counter top units when mounted on optional floor stands or pedestals provide a uniform nominal hob height of 900mm.

Electric Counter Top Fryers

- Front mounted controls ensure safe working practice
- Hinging element with safety cut-out provides easy access to tank for cleaning
- High quality grade 304 stainless steel fryer tanks, fully welded to hobs for added strength and a smooth, easy clean seamless finish
- Thermostatic control with fail-safe top temperature cut out maintains accurate oil temperature and ensures safe operation
- Heavy duty double nickel plated spun wire baskets, batter plates and stainless steel lids supplied as standard



Single tank fryers with 1 basket									
MODEL	PRICE £	PRICE €	H	W	D	POWER	OIL CAP	WT	
DF33	£866	€996	330	300	632	3kW	7.5L	17	
*DF36	£951	€1094	330	300	632	6kW	9L	18	
*DF39	£1029	€1184	330	300	632	9kW	9L	18	

Alternative half size DF basket

MODEL	PRICE £	PRICE €
A BA96	£94	€109

Single tank fryers with 2 baskets									
MODEL	PRICE £	PRICE €	H	W	D	POWER	OIL CAP	WT	
*DF46	£1163	€1338	330	450	632	6kW	15L	22	
*DF49	£1201	€1382	330	450	632	9kW	15L	23	

Doughnut fryer kit to convert Silverlink 600 counter-top fryers

MODEL	PRICE £	PRICE €	DESCRIPTION
A DC03	£216	€249	For models DF46/49



Twin tank fryers with 2 baskets									
MODEL	PRICE £	PRICE €	H	W	D	POWER	OIL CAP	WT	
DF66	£1455	€1674	330	600	632	2x3kW	2x7.5L	26	
*DF612	£1736	€1997	330	600	632	2x6kW	2x9L	31	
*DF618	£1805	€2076	330	600	632	2x9kW	2x9L	33	

Model DF66 supplied with two cables & plugs for easy installation

Single tank fryer with 3 baskets									
MODEL	PRICE £	PRICE €	H	W	D	POWER	OIL CAP	WT	
*DF66/ST	£1279	€1471	330	600	632	6kW	20L	28	

Gas Counter Top Fryers

- Thermostatic control ensures accurate oil temperature control and consistently perfect results
- Safety features include flame failure device and top temperature cut-out to prevent overheating of oil
- Deep cool zone collects cooking debris - this gives cleaner cooking results and prolongs oil life, saving you money
- Convenient pilot flame operation with piezo ignition
- Heavy duty double nickel plated spun wire baskets, batter plates and stainless steel lids supplied as standard
- For very shallow frying - oil depth approximately 30mm



Single tank fryers with 2 baskets									
MODEL	PRICE £	PRICE €	H	W	D	POWER	OIL CAP	WT	
DF4/N	£2093	€2407	415	450	654	11.3kW	8L	43	
DF4/P	£2093	€2407	415	450	654	10.5kW	8L	43	

Doughnut fryer kit for model DF4

MODEL	PRICE £	PRICE €
A DC01	£216	€249

Key

H = Height (mm)
W = Width (mm)
D = Depth (mm)
WT = Packed Weight in kg

SILVERLINK 600

All gas power ratings are nominal values. All Silverlink 600 counter top units when mounted on optional floor stands or pedestals provide a uniform nominal hob height of 900mm.

Electric Free Standing Fryers

- Front mounted controls ensure safe working practice
- Hinging element with safety cut-out provides easy access to tank for cleaning
- High quality grade 304 stainless steel fryer tanks, fully welded to hobs for added strength and a smooth, easy clean seamless finish
- Thermostatic control with fail-safe top temperature cut out maintains accurate oil temperature and ensures safe operation
- Heavy duty double nickel plated spun wire baskets, batter plates and stainless steel lids supplied as standard



Single tank electric fryer (300mm wide)								
MODEL	PRICE £	PRICE €	H	W	D	POWER	OIL CAP	WT
*J6	£1247	€1435	970 - 980	300	632	6kW	9L	34
*J9	£1375	€1582	970 - 980	300	632	9kW	9L	35

Twin tank electric fryer (600mm wide)								
MODEL	PRICE £	PRICE €	H	W	D	POWER	OIL CAP	WT
*J12	£2162	€2487	970 - 980	600	632	2x6kW	2x9L	54
*J18	£2291	€2635	970 - 980	600	632	2x9kW	2x9L	55

MODEL	PRICE £	PRICE €	DESCRIPTION
A BA96	£94	€109	Alternative half size basket for models J6/J9/J12/J18
S TA28	£105	€120.75	2 Gallon Bucket for J Fryers
S ST10	£37.25	€42.85	Strainer for J fryers

Gas Free Standing Fryers

- Thermostatic control ensures accurate oil temperature control and consistently perfect results
- Safety features include flame failure device and top temperature cut-out to prevent overheating of oil
- Deep cool zone collects cooking debris - this gives cleaner cooking results and prolongs oil life, saving you money
- Convenient pilot flame operation with piezo ignition
- Heavy duty double nickel plated spun wire baskets, batter plates and stainless steel lids supplied as standard



Single tank gas fryer (300mm wide)								
MODEL	PRICE £	PRICE €	H	W	D	POWER	OIL CAP	WT
J5/N	£2444	€2811	1060 - 1100	300	690	12kW	12L	52
J5/P	£2444	€2811	1060 - 1100	300	690	11.3kW	12L	52

Twin tank gas fryer (600mm wide)								
MODEL	PRICE £	PRICE €	H	W	D	POWER	OIL CAP	WT
J10/N	£4001	€4602	1060 - 1100	600	690	24kW	2x12L	87
J10/P	£4001	€4602	1060 - 1100	600	690	22.6kW	2x12L	87

Electric Chip Scuttles

- Heated from below
- Removable tank and drain plate for easy cleaning
- Drain plate keeps contents crisp and fresh
- Easy access and better heat retention via hinged lid



Chip scuttle							
MODEL	PRICE £	PRICE €	H	W	D	POWER	WT
CS4	£683	€786	290	450	600	0.5kW	19
CS6	£812	€934	290	600	600	0.75kW	23

Electric Chip Scuttle with Overhead Gantry

- Heated from above and below to maintain even temperature of food
- Overhead heat lamp imparts a warm glow for attractive presentation
- Removable 1/1 GN size chip container for ease of cleaning
- Drain plate keeps contents crisp and fresh



Chip scuttle with overhead gantry							
MODEL	PRICE £	PRICE €	H	W	D	POWER	WT
CS4/G	£1043	€1200	645	450	600	1kW	23

2 YEAR

UK parts and labour warranty

Export parts warranty

on all Lincat products

SILVERLINK 600

All gas power ratings are nominal values.

Electric Salamander Grill

- Even heat distribution - for perfect grilling
- Easy to clean stainless steel interior
- Five grill shelf positions
- Crumb tray and toasting grid included as standard



Electric salamander grill							
MODEL	PRICE £	PRICE €	H	W	D	POWER	WT
GR3	£683	€786	314	600	350	2.8kW	22

Accessories for GR3

MODEL	PRICE £	PRICE €	DESCRIPTION	H
A BR15	£65	€75	Wall brackets	N/A
A ABP03	£334	€385	Single-sided alloy branding plate & drip tray	N/A
A GR3/WS	£208	€240	Wall shelf	N/A
A GR3/BS	£314	€362	Bench stand	350
A GR3/FS	£549	€632	Floor stand	1230

Electric Adjustable Salamander Grills

- Ideal for grilling and gratination
- Smooth action and easy-lift grill hood
- Height markings and an audible timer to ensure consistent results
- Removable fat collection tray and chromed toasting rack included as standard
- 1/1 GN compatible



Electric adjustable salamander grill							
MODEL	PRICE £	PRICE €	H	W	D	POWER	WT
AS3	£1956	€2250	500	600	472	2.8kW	59
*AS4	£2088	€2402	500	600	472	4.5kW	59

MODEL	PRICE £	PRICE €	DESCRIPTION
A BR51	£95	€110	Wall mounting brackets

Gas Salamander Grills

- Powerful ceramic plaque burners
- Vitreous enamelled interior and hood for easy cleaning
- Cool to the touch handles
- Model GR3N/P supplied with crumb tray and toasting grid as standard
- Model GR7N/P supplied with a double sided alloy branding plate and fat collection tray as standard



Gas salamander grill							
MODEL	PRICE £	PRICE €	H	W	D	POWER	WT
GR3/N	£1482	€1705	408	600	423	5kW	24
GR3/P	£1482	€1705	408	600	423	5kW	24

Accessories for GR3/N and GR3/P

MODEL	PRICE £	PRICE €	DESCRIPTION	H
A ABP03	£334	€385	Single-sided alloy branding plate & drip tray	N/A
A GR3/WS	£208	€240	Wall shelf	N/A
A GR3/BS	£314	€362	Bench stand	350
A GR3/FS	£549	€632	Floor stand	1230



Gas salamander grill							
MODEL	PRICE £	PRICE €	H	W	D	POWER	WT
GR7/N	£2178	€2505	405	750	423	6.5kW	44
GR7/P	£2178	€2505	405	750	423	6.5kW	44

Accessories for GR7/N and GR7/P

MODEL	PRICE £	PRICE €	DESCRIPTION	H
A BR39	£304	€350	Additional double-sided alloy branding plate	N/A
A GR7/WS	£247	€285	Wall shelf	N/A
A GR7/BS	£356	€410	Bench stand	350
A GR7/FS	£628	€723	Floor stand	1230

* Please refer to pages L90 to L91 for electricity supply requirements

SILVERLINK 600

All gas power ratings are nominal values. All Silverlink 600 counter top units when mounted on optional floor stands or pedestals provide a uniform nominal hob height of 900mm.

Electric Griddles

- Solid 12mm thick machined steel plate ensures even heat distribution and excellent heat retention
- Fully-welded plates eliminate dirt traps
- Thermostatically controlled for consistent performance
- Models with extra power (/E) available



Machine steel plate griddles							
MODEL	PRICE £	PRICE €	H	W	D	POWER	WT
GS3	£768	€884	330	300	600	2kW	24
GS3/E	£858	€987	330	300	600	2.5kW	25
GS4	£904	€1040	330	450	600	2.7kW	42
GS4/E	£983	€1131	330	450	600	3.7kW	43
GS6	£1034	€1190	330	600	600	3kW	51
*GS6S	£1088	€1252	330	600	620	4.5kW	53
*‡GS6/T	£1134	€1305	330	600	620	4kW	55
*‡GS6/T/E	£1196	€1376	330	600	620	5.6kW	55
*‡GS7	£1247	€1435	330	750	620	6kW	69
*‡GS7/E	£1302	€1498	330	750	620	7kW	67
*‡GS9	£1493	€1717	330	900	620	8.6kW	81

‡ Dual zone

Hard chrome plate griddles							
MODEL	PRICE £	PRICE €	H	W	D	POWER	WT
GS3/C	£1736	€1997	330	300	600	2kW	24
GS4/C	£2025	€2329	330	450	600	2.7kW	43
GS6/C	£2330	€2680	330	600	600	3kW	56
*‡GS6C/T	£2545	€2927	330	600	620	4kW	54
*‡GS7/C	£2789	€3208	330	750	620	6kW	68

‡ Dual zone

Half-ribbed griddles							
MODEL	PRICE £	PRICE €	H	W	D	POWER	WT
*‡GS6/TR	£1293	€1487	330	600	620	4kW	53
*‡GS6/TR/E	£1360	€1564	330	600	620	5.6kW	53
*‡GS7/R	£1416	€1629	330	750	620	6kW	69

‡ Dual zone

Fully-ribbed griddle							
MODEL	PRICE £	PRICE €	H	W	D	POWER	WT
*‡GS6/TFR	£1513	€1740	330	600	620	4kW	54

‡ Dual zone

Griddle splashbacks

MODEL	PRICE £	PRICE €	DESCRIPTION
A SB3	£112	€129	For GS3 griddles
A SB4	£125	€144	For GS4 griddles
A SB6	£127	€147	For GS6 griddles
A SB7	£137	€158	For GS7 griddles
A SB9	£141	€163	For GS9 griddles

Note: All splashbacks are 115mm high

Key

H = Height (mm)
W = Width (mm)
D = Depth (mm)
WT = Packed Weight in kg

Gas Griddles

- Solid 12mm thick machined steel plate ensures even heat distribution and excellent heat retention
- Fully-welded plates eliminate dirt traps
- High and low heat settings for controlled cooking
- Piezo ignition and flame failure device for convenient and safe operation



Machine steel plate griddles							
MODEL	PRICE £	PRICE €	H	W	D	POWER	WT
GS4/N	£1522	€1751	415	450	650	5.4kW	49
GS4/P	£1522	€1751	415	450	650	5.5kW	49
‡GS7/N	£2162	€2487	415	750	650	7.5kW	70
‡GS7/P	£2162	€2487	415	750	650	8kW	70

‡ Dual zone

Griddle splashbacks

MODEL	PRICE £	PRICE €	DESCRIPTION
A SB4	£125	€144	For GS4 griddles
A SB7	£137	€158	For GS7 griddles

Half-ribbed griddles							
MODEL	PRICE £	PRICE €	H	W	D	POWER	WT
‡GS7R/N	£2316	€2664	415	750	650	7.5kW	70
‡GS7R/P	£2316	€2664	415	750	650	8kW	70

‡ Dual zone

Product Codes

/N = natural gas /P = propane gas Btu/hr = kW x 3412

SILVERLINK 600

All gas power ratings are nominal values. All Silverlink 600 counter top units when mounted on optional floor stands or pedestals provide a uniform nominal hob height of 900mm.

Gas Chargrills

- Heat transfer radiants eliminate the need for messy lava rock
- Removable branding grids, heat transfer radiants, fat collection drawer and debris collection tray for easy cleaning
- Adjustable cooking grid and variable heat control for maximum controllability
- Heat retaining cooking grids produces clean, sharp branding marks to enhance food presentation
- Twin heat zones



MODEL	PRICE £	PRICE €	H	W	D	POWER	WT
CG4/N	£1639	€1885	414	450	652	16.4kW	36
CG4/P	£1639	€1885	414	450	652	17.6kW	36

MODEL	PRICE £	PRICE €	H	W	D	POWER	WT
CG6/N	£2137	€2458	414	600	652	16.4kW	48
CG6/P	£2137	€2458	414	600	652	17.6kW	48

Electric Chargrills

- High heat retention of cast iron grids means there is no waiting for the grill to recover to cooking temperature
- Hinging interlocked elements and integral water bath make cleaning easier
- Integral splashguard with water funnel enables refilling of tank without cooling the cooking grid
- Water bath provides humidity, keeping food succulent and reducing shrinkage
- High temperature safety cut out for protection if water bath runs dry
- ECG9/WT features water connection for ease of use



MODEL	PRICE £	PRICE €	H	W	D	POWER	WT
*ECG6	£1985	€2283	385	600	620	8kW	41
*ECG9	£3217	€3700	385	900	620	13.3kW	67
*ECG9/WT	£3741	€4303	385	900	620	13.3kW	67

Electric Pasta Boilers

- Front mounted controls ensure safe working practice
- Hinging element with safety cut out provides easy access to tank for cleaning
- Front drain taps for fast, easy drainage of water
- Thermostatic control maintains accurate water temperature
- Corrosion-resistant stainless steel tanks and elements for long service life



MODEL	PRICE £	PRICE €	H	W	D	POWER	WT
PB33	£972	€1118	330	300	600	3kW	15

Price does not include basket

MODEL	PRICE £	PRICE €	H	W	D	POWER	WT
PB66	£1650	€1898	330	600	600	2x3kW	27

Price does not include basket
Supplied with two cables & plugs for easy installation

Pasta Baskets

MODEL	PRICE £	PRICE €	W	PB33 NO. REQUIRED
A BA112	£171	€197	202	1
A BA114	£164	€189	101	2
A BA115+ BB116 (each)	£136 (each)	€157 (each)	101	2 of each

Pasta Baskets

MODEL	PRICE £	PRICE €	W	PB33 NO. REQUIRED
A BA112	£171	€197	202	1
A BA114	£164	€189	101	2
A BA115+ BB116 (each)	£136 (each)	€157 (each)	101	4 of each

PB33



1 x BA112



2 x BA114



2 x BA115
2 x BA116

PB66



2 x BA112



4 x BA114



4 x BA115
4 x BA116

Key

H = Height (mm)
W = Width (mm)
D = Depth (mm)
WT = Packed Weight in kg

2 YEAR

UK parts
and labour
warranty

Export
parts
warranty

on all Lincat
products

Product Codes

/N = natural gas /P = propane gas Btu/hr = kW x 3412

SILVERLINK 600

All gas power ratings are nominal values. All Silverlink 600 counter top units when mounted on optional floor stands or pedestals provide a uniform nominal hob height of 900mm.

Electric Bains Marie (Round Pots)

- Perfect for safely holding sauces, gravy and pre-cooked foods for up to two hours at serving temperature
- Adjustable heat control
- 8 pint (4.5 litre) stainless steel pots included



Dry heat bains marie							
MODEL	PRICE £	PRICE €	H	W	D	POWER	WT
BS3	£561	€646	325	300	600	0.5kW	15

Dry heat bains marie							
MODEL	PRICE £	PRICE €	H	W	D	POWER	WT
BS4	£722	€831	325	450	600	0.75kW	18

Dry heat bains marie							
MODEL	PRICE £	PRICE €	H	W	D	POWER	WT
BS7	£876	€1008	325	750	600	1kW	28

Wet heat bains marie							
MODEL	PRICE £	PRICE €	H	W	D	POWER	WT
BS3W	£713	€820	325	300	600	1kW	16

Wet heat bains marie							
MODEL	PRICE £	PRICE €	H	W	D	POWER	WT
BS4W	£858	€987	325	450	600	1kW	19

Wet heat bains marie							
MODEL	PRICE £	PRICE €	H	W	D	POWER	WT
BS7W	£1095	€1260	325	750	600	2kW	29

Key

- H = Height (mm)
- W = Width (mm)
- D = Depth (mm)
- WT = Packed Weight in kg

Electric Bains Marie (Gastronorm Dishes)

- Perfect for safely holding sauces, gravy and pre-cooked foods for up to two hours at serving temperature
- Adjustable heat control
- Available as base units or with a choice of 150mm deep gastronorm dishes



Dry heat bains marie							
MODEL	PRICE £	PRICE €	H	W	D	POWER	WT
BM3	£516	€594	290	300	600	0.5kW	13
BM3A	£642	€739	290	300	600	0.5kW	15

Dry heat bains marie							
MODEL	PRICE £	PRICE €	H	W	D	POWER	WT
BM4	£622	€716	290	450	600	0.75kW	15
BM4A	£744	€856	290	450	600	0.75kW	18
BM4B	£744	€856	290	450	600	0.75kW	18
BM4C	£713	€820	290	450	600	0.75kW	18
BM4D	£744	€856	290	450	600	0.75kW	18
BM4E	£744	€856	290	450	600	0.75kW	18

Dry heat bains marie							
MODEL	PRICE £	PRICE €	H	W	D	POWER	WT
BM6	£691	€795	290	600	600	0.75kW	17
BM6A	£876	€1008	290	600	600	0.75kW	22
BM6B	£836	€962	290	600	600	0.75kW	22
BM6C	£912	€1049	290	600	600	0.75kW	22

Dry heat bains marie							
MODEL	PRICE £	PRICE €	H	W	D	POWER	WT
BM7	£843	€970	290	750	600	1kW	23
BM7A	£1088	€1252	290	750	600	1kW	30
BM7B	£1080	€1242	290	750	600	1kW	29
BM7C	£1140	€1311	290	750	600	1kW	30
BM7X	£836	€962	290	750	600	1kW	22
BM7XA	£983	€1131	290	750	600	1kW	28
BM7XB	£1029	€1184	290	750	600	1kW	27
BM7XC	£1088	€1252	290	750	600	1kW	28



Wet heat bains marie							
MODEL	PRICE £	PRICE €	H	W	D	POWER	WT
BM3W	£645	€742	290	300	600	1kW	14
BM3AW	£791	€910	290	300	600	1kW	15

Wet heat bains marie							
MODEL	PRICE £	PRICE €	H	W	D	POWER	WT
BM4W	£763	€878	290	450	600	1kW	16
BM4AW	£889	€1023	290	450	600	1kW	19
BM4BW	£897	€1032	290	450	600	1kW	19
BM4CW	£858	€987	290	450	600	1kW	19
BM4DW	£889	€1023	290	450	600	1kW	19
BM4EW	£897	€1032	290	450	600	1kW	19

Wet heat bains marie							
MODEL	PRICE £	PRICE €	H	W	D	POWER	WT
BM6W	£836	€962	290	600	600	2kW	19
BM6AW	£1029	€1184	290	600	600	2kW	24
BM6BW	£996	€1146	290	600	600	2kW	24
BM6CW	£1066	€1226	290	600	600	2kW	24

Wet heat bains marie							
MODEL	PRICE £	PRICE €	H	W	D	POWER	WT
BM7W	£983	€1131	290	750	600	2kW	23
BM7AW	£1263	€1453	290	750	600	2kW	30
BM7BW	£1222	€1406	290	750	600	2kW	29
BM7CW	£1316	€1514	290	750	600	2kW	29
BM7XW	£989	€1138	290	750	600	2kW	22
BM7XAW	£1150	€1323	290	750	600	2kW	28
BM7XBW	£1187	€1366	290	750	600	2kW	28
BM7XCW	£1222	€1406	290	750	600	2kW	28

Bains Marie Gastronorm configurations

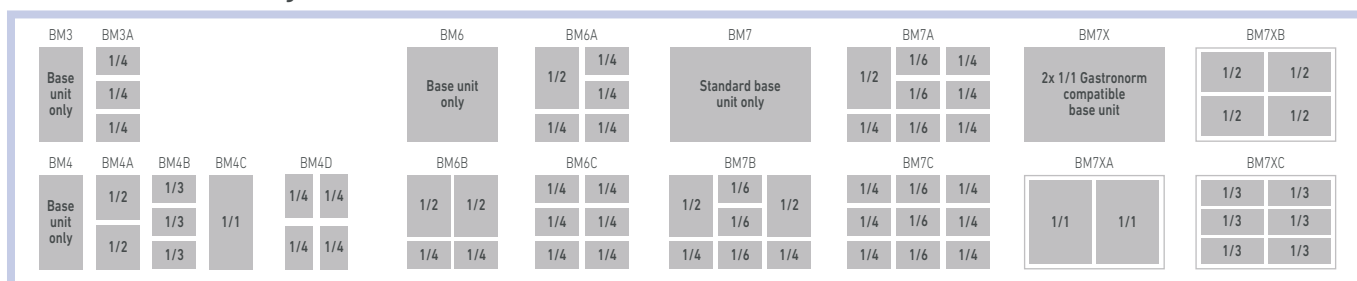

SILVERLINK 600

All Silverlink 600 counter top units when mounted on optional floor stands or pedestals provide a uniform nominal hob height of 900mm.

Work Tops

- Designed to match Silverlink 600 appliances
- Provides useful work space
- Models with drawers provide handy additional storage space



Work tops						
MODEL	PRICE £	PRICE €	H	W	D	WT
WT3	£217	€250	290	300	600	8
WT4	£241	€278	290	450	600	10
WT6	£252	€290	290	600	600	13
WT7	£288	€332	290	750	600	16

Work tops with drawers						
MODEL	PRICE £	PRICE €	H	W	D	WT
WT3D	£400	€460	290	300	600	12
WT4D	£412	€474	290	450	600	14
WT6D	£460	€529	290	600	600	18

Stands

- Designed to support Silverlink 600 electric or gas counter-top units
- Sturdy, robust stainless steel construction with fully welded joints
- Multiple counter-top units may be supported on a single base
- Adjustable legs provide stability on uneven floors
- No dirt traps means quick, easy cleaning
- Stands SLS6V and SLS7V for use with V6 and V7 series ovens



Stands						
MODEL	PRICE £	PRICE €	H	W	D	WT
A SLS3	£431	€496	650 - 662	300	567	14
A SLS4	£452	€520	650 - 662	450	567	16
A SLS6	£514	€592	650 - 662	600	567	16
A SLS7	£606	€679	650 - 662	750	567	19
A SLS9	£693	€797	650 - 662	900	567	29

Stands for V Ovens						
MODEL	PRICE £	PRICE €	H	W	D	WT
A SLS6V	£524	€603	650 - 662	600	567	17
A SLS7V	£607	€699	650 - 662	750	567	19

Suitable for use with gas products

Pedestals

- Designed to support Silverlink 600 electric or gas counter-top units
- Adjustable shelf provides flexibility
- Adjustable for perfect alignment on uneven floors
- Heated models feature thermostatic control - ideal as plate warmers
- CC, HC and HCL models feature doors which fit left or right handed for flexibility in kitchen planning



Ambient open-top pedestals without doors						
MODEL	PRICE £	PRICE €	H	W	D	WT
A CN3	£392	€451	650 - 660	300	600	16
A CN4	£407	€469	650 - 660	450	600	20
A CN6	£465	€535	650 - 660	600	600	24
A CN7	£524	€603	650 - 660	750	600	31

Additional shelves for pedestals			
MODEL	PRICE £	PRICE €	FOR UNIT WIDTHS
A PSH3	£47	€55	300mm
A PSH4	£56	€65	450mm
A PSH6	£64	€74	600mm
A PSH7	£74	€86	750mm

Ambient open-top pedestals with doors						
MODEL	PRICE £	PRICE €	H	W	D	WT
A CC3	£492	€566	650 - 660	300	600	18
A CC4	£506	€582	650 - 660	450	600	23
A CC6	£562	€647	650 - 660	600	600	29
A CC7	£647	€745	650 - 660	750	600	37

Additional shelves for pedestals			
MODEL	PRICE £	PRICE €	FOR UNIT WIDTHS
A PSH3	£47	€55	300mm
A PSH4	£56	€65	450mm
A PSH6	£64	€74	600mm
A PSH7	£74	€86	750mm

Not suitable for use with gas products

Not suitable for use with gas products



2

YEAR

UK parts and labour warranty

Export parts warranty

on all Lincat products



Heated open-top pedestals with doors						
MODEL	PRICE £	PRICE €	H	W	D	POWER WT
A HC3	£621	€715	650 - 660	300	600	0.25kW 17
A HC4	£654	€753	650 - 660	450	600	0.5kW 25
A HC6	£679	€781	650 - 660	600	600	0.5kW 32
A HC7	£775	€892	650 - 660	750	600	0.5kW 37

Not suitable for use with gas products

Heated pedestals with legs and doors						
MODEL	PRICE £	PRICE €	H	W	D	POWER WT
A HCL3	£686	€789	650 - 668	300	600	0.25kW 24
A HCL4	£716	€824	650 - 668	450	600	0.5kW 27
A HCL6	£775	€892	650 - 668	600	600	0.5kW 34
A HCL7	£823	€947	650 - 668	750	600	0.75kW 46
A HCL9	£903	€1039	650 - 668	900	600	1kW 53

Not suitable for use with gas products

Additional shelves for pedestals			
MODEL	PRICE £	PRICE €	FOR UNIT WIDTHS
A PSH3	£47	€55	300mm
A PSH4	£56	€65	450mm
A PSH6	£64	€74	600mm
A PSH7	£74	€86	750mm

Additional shelves for pedestals			
MODEL	PRICE £	PRICE €	FOR UNIT WIDTHS
A PSH3	£47	€55	300mm
A PSH4	£56	€65	450mm
A PSH6	£64	€74	600mm
A PSH7	£74	€86	750mm
A PSH9	£91	€105	900mm

LYNX400



Produce perfect plates of food in no time with the Lynx 400 plug in and play series.

The electric Lynx 400 series is designed to be portable. The units are compact, but what they lack in size they more than make up for in quality.

There's no complicated set up process with the Lynx 400 series. They're ready to go immediately, which means you only have to think about the range of delicious dishes you're going to create.

Made in the UK, the series is sturdy and built to last. Whatever the product - fryers, griddles, pasta boilers or pizza ovens - you can rely on them not to let you down.

Ideally suited for...

The products within the Lynx 400 series are highly portable and compact, making them perfect for cafés and pubs as well as event catering.



Cafés

The series is great if you're looking to offer customers light meals and snacks, such as toasted sandwiches and fries.



Pubs

Space saving, the range is perfect for crispy chips, delicious pasta and perfect pizzas, among other great dishes.

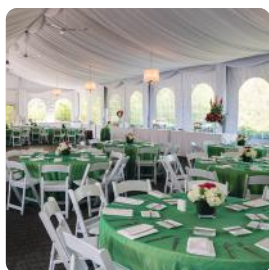

Events

If you cater at events, you'll love the portability of the Lynx 400 series. What's more, the products are designed to plug in and play, so there's no set up times to worry about.

The Lynx 400 range is full of compact, quality products that are designed to plug in and play.

Benefits at a glance

- Typically 400mm deep
- Plug in and play
- Portable
- Robust
- Quality - made in the UK
- Easy to clean

LYNX⁴⁰⁰

Convection Ovens

- Compact footprint, starting at 40.5cm wide there is a convection oven for even the smallest of outlets
- Direct placement of gastronorms and trays on racks maximises oven space
- LCOS and LCOT supplied with 2 shelves, LCOXL supplied with 3 shelves
- Powerful fan assisted cooking for uniform cooking and consistent results
- Powerful 2.5kW oven for rapid heat up
- Simple dial controls with 60 minute timer
- Side opening door with double glass viewing panel delivering energy efficiency and safe cool touch door
- 13 Amp plug for easy plug and play operation
- User replaceable inner door glass, light bulb and door seal so maintenance is fuss free
- 2 years on site parts and labour warranty, in the event of an issue we will send an engineer to site, minimising downtime and inconvenience for the end user

**LCO Slim (LCOS)**

Accommodates 4 x 1/2 gastronorms

- Heat up time 0 - 200°C - 7 mins, 50 secs
- Output from 24 frozen croissants per hour
- Output from 30 demi baguettes per hour

**LCO Tall (LCOT)**

Accommodates 4 x 2/3 gastronorms

- Heat up time 0 - 200°C - 10 mins, 40 secs
- Output from 32 frozen croissants per hour
- Output from 48 demi baguettes per hour

**LCO XL (LCOXL)**

Accommodates 4 x 1/1 gastronorms

- Heat up time 0 - 200°C - 15 min, 45 secs
- Output from 48 frozen croissants per hour
- Output from 60 demi baguettes per hour

Convection Ovens							
MODEL	PRICE £	PRICE €	H	W	D	POWER	WT
LCOS	£988	€1137	520	405	570	2.5kW	34
LCOT	£1016	€1169	520	495	570	2.5kW	38
LCOXL	£1316	€1514	605	670	570	2.5kW	60

	MODEL	PRICE £	PRICE €	DESCRIPTION
A	SH140	£34.05	€39.20	Additional LCOS Shelf
A	SH139	£36.40	€41.90	Additional LCOT Shelf
A	SH141	£56.35	€64.85	Additional LCOXL Shelf



- Fan assisted for uniform heat and consistent cooking results
- Double-glazed glass door and internal light for safe, energy-efficient operation
- Two removable chromed rod shelves
- Stainless steel interior for easy cleaning
- User-replaceable inner door glass, light bulb and door seal - avoids costly service calls for routine maintenance

Counter-top convection oven							
MODEL	PRICE £	PRICE €	H	W	D	POWER	WT
LCO	£1028	€1183	371	555	488	2.5kW	30

2
YEARUK parts
and labour
warrantyExport
parts
warranty

on all Lincat products



Pizza Deck Oven

- Compact footprint, only 53cm wide
- Small unit, large capacity, deliver up to 14" pizzas
- Firebrick base to produce high-quality, crisp pizzas with authentic taste
- Make a style statement, available in black, red and stainless steel
- Temperature display gauge for easy monitoring
- Independently controlled top and bottom elements
- 18 minute timer
- Maximum temperature 400°C

- Easy plug and play operation - 13A plug
- Easy clean stainless steel design
- Heat up time 0 - 400°C - 39 minutes
- Cook time 14" pizza - 2 minutes, 30 seconds*
- Output per hour - 24 x 14" pizza*

*Based on a fresh dough pizza. Total cooking time: 2 minutes 50 seconds, with 30 seconds allowed for loading and unloading. Temperature of 350°C.



LDPO/B



LDPO/S



LDPO/R

Pizza deck ovens							
MODEL	PRICE £	PRICE €	H	W	D	POWER	WT
LDPO/S	£1144	€1316	300	530	558	2.2kW	41
LDPO/B	£1144	€1316	300	530	558	2.2kW	41
LDPO/R	£1144	€1316	300	530	558	2.2kW	41

MODEL	PRICE £	PRICE €	DESCRIPTION
A LT01	£63	€73	Loading Tool

Pizza Oven

- Upper and lower elements for effective cooking of pizzas
- Thermostatic control for perfect cooking results
- Mechanical ring timer for precise cooking
- Wire shelf with safety stop
- Powerful - temperature up to 300°C for rapid cooking and crisp bases



Pizza oven							
MODEL	PRICE £	PRICE €	H	W	D	POWER	WT
LPO	£721	€830	184	545	499	1.5kW	23

Griddle

- Compact, low-profile design
- Excellent even heat allows you to use the whole plate
- One piece cast iron griddle plate with integral splashguard
- Fast heat up from cold
- Thermostatic control for accurate repeatable results



Griddles							
MODEL	PRICE £	PRICE €	H	W	D	POWER	WT
LGR	£506	€582	163	315	400	2kW	13
LGR2	£638	€734	163	615	400	3kW	23

Key

- H = Height (mm)
- W = Width (mm)
- D = Depth (mm)
- WT = Packed Weight in kg

2 YEAR UK parts and labour warranty | Export parts warranty
on all Lincat products



Contact / Panini Grills

- Enamelled cast iron plates give excellent heat retention and are easy to clean
- Fast heat up from cold
- Thermostatic control for accurate repeatable results
- Compact, low-profile design
- Twin models supplied with two cables and plugs for easy installation



Single contact grill (smooth upper & lower plates)							
MODEL	PRICE £	PRICE €	H	W	D	POWER	WT
LCG	£801	€922	182	293	400	2.25kW	21

Single ribbed grill (ribbed upper & smooth lower plates)							
MODEL	PRICE £	PRICE €	H	W	D	POWER	WT
LRG	£801	€922	182	293	400	2.25kW	22

Twin contact grill (smooth upper & lower plates)							
MODEL	PRICE £	PRICE €	H	W	D	POWER	WT
LCG2	£1398	€1608	182	623	400	4.5kW	41

Twin ribbed grill (ribbed upper & smooth lower plates)							
MODEL	PRICE £	PRICE €	H	W	D	POWER	WT
LRG2	£1398	€1608	182	623	400	4.5kW	43

Single panini grill (ribbed upper & lower plates)							
MODEL	PRICE £	PRICE €	H	W	D	POWER	WT
LPG	£801	€922	182	293	400	2.25kW	23

Omelette spacer			
MODEL	PRICE £	PRICE €	
A OS2	£59	€68	

Twin panini grill (ribbed upper & lower plates)							
MODEL	PRICE £	PRICE €	H	W	D	POWER	WT
LPG2	£1398	€1608	182	623	400	4.5kW	45

Omelette spacer			
MODEL	PRICE £	PRICE €	
A OS2	£59	€68	

High Powered Contact / Panini Grills

- Large capacity
- Ideal for front-of-house use
- Seals in juices and flavour for succulent results - and minimal shrinkage
- Cast aluminium plates and mica heating elements for extremely even heat and precise control
- PTFE base non-stick coating for ease of cleaning



Pasta Boiler

- Lift out control panel and element for easy cleaning
- Corrosion-resistant elements for long service life
- High quality grade 304 stainless steel tanks and basket support plate
- Interlock for added safety (the power is cut if the control head is not in place)
- Boil dry protection for prolonged element life
- Supplied with a perforated basket as standard (optional half size inserts available)



Heavy duty contact grill (smooth upper & lower plates)							
MODEL	PRICE £	PRICE €	H	W	D	POWER	WT
GG1	£1625	€1869	276	395	356	3kW	25

Heavy duty panini grill (ribbed upper & smooth lower plates)							
MODEL	PRICE £	PRICE €	H	W	D	POWER	WT
GG1P	£1625	€1869	276	395	356	3kW	25

Pasta boiler							
MODEL	PRICE £	PRICE €	H	W	D	POWER	WT
LPB	£657	€756	315	270	417	3kW	10

Heavy duty ribbed grill (ribbed upper & lower plates)							
MODEL	PRICE £	PRICE €	H	W	D	POWER	WT
GG1R	£1625	€1869	276	395	356	3kW	25

Accessories for LPB							
MODEL	PRICE £	PRICE €	DESCRIPTION				
A BA158	£64	€74	Half size basket insert (requires two per basket)				

Sandwich spacer			
MODEL	PRICE £	PRICE €	
A SS1	£45	€52	

Omelette spacer			
MODEL	PRICE £	PRICE €	
A OS1	£55	€64	

2 YEAR UK parts and labour warranty | Export parts warranty on all Lincat products

Salamander Grill

- Ideal for grilling a wide variety of food products, including meat
- Powerful and robust tubular sheathed element
- Even heat provides maximum output
- Supplied with a toasting rack and grill pan - with stay-cool handles
- Durable vitreous enamelled fascia for easy cleaning



Salamander grill							
MODEL	PRICE £	PRICE €	H	W	D	POWER	WT
LGT	£539	€620	322	553	320	3kW	17

Brackets for LGT

MODEL	PRICE £	PRICE €
A BR15	£65	€75

Infra-red Grills

- Rapid heat up - save energy by switching on just when you need to use it
- Durable vitreous enamel fascia for easy cleaning
- Accurate electrical timer for precise cooking control
- Six clip-in, user-changeable quartz infra-red elements give a warm attractive glow (great for front of house situations)
- Model LPC offers variable heat control of lower elements
- Model LSC offers variable heat control of both upper and lower elements



Pizzachef infra-red grill with rod shelf							
MODEL	PRICE £	PRICE €	H	W	D	POWER	WT
LPC	£592	€681	325	552	302	3kW	14



Superchef infra-red grill with rod shelf & spillage pan							
MODEL	PRICE £	PRICE €	H	W	D	POWER	WT
LSC	£611	€703	325	552	302	3kW	18

MODEL	PRICE £	PRICE €	DESCRIPTION
A BR15	£65	€75	Wall brackets
C T010	£114.25	€131.40	Toasting bags (Pack of 1000)

MODEL	PRICE £	PRICE €	DESCRIPTION
A BR15	£65	€75	Wall brackets
C T010	£114.25	€131.40	Toasting bags (Pack of 1000)

Fryers

- Removable control head and elements for easy cleaning
- Thermostatic control with fail-safe top temperature cut-out
- Removable stainless steel tank and batter plate for easy cleaning
- Batter plate, stainless steel lid and nickel plated basket supplied as standard
- Twin tank LDF2 model supplied with two cables and plugs for easy installation



Slimline standby fryer							
MODEL	PRICE £	PRICE €	H	W	D	POWER	OIL CAP WT
LSF	£423	€487	315	184	417	2.5kW	2.5L 8



Single tank general purpose fryer							
MODEL	PRICE £	PRICE €	H	W	D	POWER	OIL CAP WT
LDF	£439	€505	315	270	417	3kW	4L 13



Twin tank general purpose fryer							
MODEL	PRICE £	PRICE €	H	W	D	POWER	OIL CAP WT
LDF2	£842	€969	315	540	417	2x3kW	2x4L 18



Fish fryer							
MODEL	PRICE £	PRICE €	H	W	D	POWER	OIL CAP WT
LFF	£577	€664	315	360	417	3kW	5L 12

Chip Scuttle

- Holds chips and other cooked products at perfect serving temperature
- Perforated drain plate gives easy access and helps to keep chips crisp
- Easy to clean - removable drain plate and interior
- Adjustable temperature control



Chip Scuttle							
MODEL	PRICE £	PRICE €	H	W	D	POWER	WT
LCS	£399	€459	232	285	400	0.25kW	9

Boiling Tops

- Compact, low-profile design
- 180 mm / 7" sealed hotplates for easy cleaning
- Variable heat control
- Automatic power reduction, if pan boils dry or is removed - prolonging hotplate life



Single plate boiling top							
MODEL	PRICE £	PRICE €	H	W	D	POWER	WT
LBR	£302	€348	120	285	400	2kW	7



Twin plate boiling top							
MODEL	PRICE £	PRICE €	H	W	D	POWER	WT
LBR2	£423	€487	120	565	400	3kW	12

LYNX⁴⁰⁰

Bains Marie (Gastronorm Dishes)

- Perfect for holding sauces, soups, gravy and pre-cooked foods for up to 2 hours at serving temperature
- Adjustable heat control gives added versatility
- Wet heat models may be operated either wet or dry
- Supplied with 100mm deep stainless steel 1/4 GN "Super Pan II" containers with lids

Key

H = Height (mm)
W = Width (mm)
D = Depth (mm)
WT = Packed Weight in kg



⚡ Bain marie - 2 x 1/4 GN (dry heat)								
MODEL	PRICE £	PRICE €	H	W	D	POWER	WT	
LBM	£379	€436	196	285	400	0.25kW	8	

⚡ Bain marie - 4 x 1/4 GN (dry heat)								
MODEL	PRICE £	PRICE €	H	W	D	POWER	WT	
LBM2	£561	€646	196	565	400	0.5kW	15	

⚡ Bain marie - 6 x 1/4 GN (dry heat)								
MODEL	PRICE £	PRICE €	H	W	D	POWER	WT	
LBM3	£654	€753	196	850	400	0.75kW	22	

⚡ Bain marie - 2 x 1/4 GN (wet heat)								
MODEL	PRICE £	PRICE €	H	W	D	POWER	WT	
LBMW	£439	€505	196	285	400	0.25kW	10	

⚡ Bain marie - 4 x 1/4 GN (wet heat)								
MODEL	PRICE £	PRICE €	H	W	D	POWER	WT	
LBM2W	£645	€742	196	565	400	0.5kW	17	

⚡ Bain marie - 6 x 1/4 GN (wet heat)								
MODEL	PRICE £	PRICE €	H	W	D	POWER	WT	
LBM3W	£791	€910	196	850	400	0.75kW	26	

Bains Marie (Round Pots)

- Perfect for holding sauces, soups, gravy and pre-cooked foods for up to 2 hours at serving temperature
- Adjustable heat control gives added versatility
- Wet heat models may be operated either wet or dry
- 8 pint (4.5 litres) stainless steel round pots and lids included as standard



⚡ Bain marie - 1 round pot (dry heat)								
MODEL	PRICE £	PRICE €	H	W	D	POWER	WT	
LRB	£307	€354	240	285	400	0.25kW	8	

⚡ Bain marie - 2 round pots (dry heat)								
MODEL	PRICE £	PRICE €	H	W	D	POWER	WT	
LRB2	£485	€558	240	565	400	0.5kW	14	

⚡ Bain marie - 3 round pots (dry heat)								
MODEL	PRICE £	PRICE €	H	W	D	POWER	WT	
LRB3	£577	€664	240	850	400	0.75kW	21	

⚡ Bain marie - 1 round pot (wet heat)								
MODEL	PRICE £	PRICE €	H	W	D	POWER	WT	
LRBW	£370	€426	240	285	400	0.25kW	9	

⚡ Bain marie - 2 round pots (wet heat)								
MODEL	PRICE £	PRICE €	H	W	D	POWER	WT	
LRB2W	£569	€655	240	565	400	0.5kW	17	

⚡ Bain marie - 3 round pots (wet heat)								
MODEL	PRICE £	PRICE €	H	W	D	POWER	WT	
LRB3W	£707	€814	240	850	400	0.75kW	23	

Lincat Specialist



Whatever your kitchen needs, you'll find a solution with the Lincat range of specialist, built-for-purpose products.

The Lincat range of products are built for specific applications, so if you have a particular need for your kitchen, you're sure to find the right product for you.

The range includes pizza ovens, convection ovens, toasters and induction hobs, among others. Each product within the range is made with care, delivering great results time after time.

Ideally suited for...

Given the variety of products within the Lincat range, there are a range of establishments that could benefit from their specific functions, including:



Cafés

Are you looking for products to produce sumptuous snacks for your café? The Lincat range includes pizza ovens to recreate the authentic Italian taste.



Bakery

Looking to produce delicious evenly baked breads and cakes. You'll find the the perfect solution with the Lincat convection oven range.

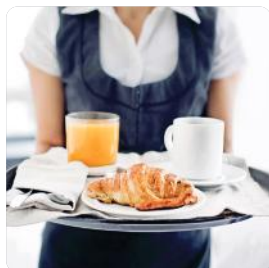

Hotels

The Lincat range offers conveyor toasters capable of making over 300 slices of perfectly crunchy toast, through to food warming drawers to keep your dishes at the optimum temperature.



Events

The Lincat Table Top Induction Hobs feature a lightweight and portable plug in design to offer the ultimate versatility.

Looking for a specific solution for your kitchen? You're sure to find it with the Lincat range of built-for-purpose products.

Benefits at a glance

- Specific functionality
- Designed-for-purpose
- Front and back of house applications

Convection Ovens

- Efficient air circulation, with twin fans for fast and even cooking
- Robust stainless steel construction
- Cook and hold facility
- Accepts 1/1 GN containers for convenient operation
- Water injection facility gives a professional finish to breads and pastries

- Double-glazed door for energy efficiency
- Stackable to make best use of limited space
- Higher powered model ECO9 has larger oven and offers faster heat up and recovery times



Counter-top convection oven							
MODEL	PRICE £	PRICE €	H	W	D	POWER	WT
ECO8	£2735	€3146	575	787	644	3kW	84
Internal dimensions			430	600	504		

(765mm deep with water supply connected)

Floor stand for model ECO8

MODEL	PRICE £	PRICE €	H	W	D
A ECO8/FS	£912	€1049	930	787	589

Holds 12 x 1/1GN containers

Low level floor stand for use with ECO8

MODEL	PRICE £	PRICE €	H	W	D
A ECO8/LFS	£697	€802	410	787	589

Holds 4 x 1/1GN containers

Kit for stacking 2 x ECO8

MODEL	PRICE £	PRICE €	DESCRIPTION	H
A ECO8/SK	£310	€357	ECO8 Stacking kit	60

2

YEAR

UK parts and labour warranty

Export parts warranty

on all Lincat products

Counter-top convection oven							
MODEL	PRICE £	PRICE €	H	W	D	POWER	WT
*ECO9	£4351	€5004	652	766	840	7.5kW	101
Internal dimensions			510	480	700		

(845mm deep with water supply connected)

Floor stand for model ECO9

MODEL	PRICE £	PRICE €	H	W	D
A ECO9/FS	£952	€1095	930	766	757

Holds 12 x 1/1GN containers

Baking tray compatible floor stand for model ECO9

MODEL	PRICE £	PRICE €	H	W	D
A ECO9/FSBT	£966	€1111	930	766	757

Low level floor stand for use with ECO9

MODEL	PRICE £	PRICE €	H	W	D
A ECO9/LFS	£820	€943	410	766	757

Holds 4 x 1/1GN containers

Kit for stacking 2 x ECO9

MODEL	PRICE £	PRICE €	DESCRIPTION	H
A ECO9/SK	£342	€394	ECO9 Stacking kit	60

Induction Hobs

- Single and twin cooking zones for high output
- High efficiency - delivers almost twice the cooking power of a similarly rated gas hob
- Functional and attractive profile is perfect for front of house theatre style cooking
- 6mm thick high impact resistant glass ceramic surface to withstand hard knocks



Induction hob								
MODEL	PRICE £	PRICE €	H	W	D	ZONES	POWER	WT
IH3	£1486	€1709	115	400	654	1	2.4kW	15
IH21	£1501	€1727	115	350	654	2	3kW	15
IH42	£2696	€3101	115	600	654	4	2 x 3kW	28

Key

H = Height (mm)
 W = Width (mm)
 D = Depth (mm)
 WT = Packed Weight in kg

Food Warming Drawers

- Pre-set thermostat keeps food at constant temperature
- Humidity facility keeps contents moist for extended periods
- Full insulation ensures energy efficiency and safe, cool surfaces and controls
- Large removable drawers for ease of cleaning
- Smooth action stainless steel runners



Food warming drawers							
MODEL	PRICE £	PRICE €	H	W	D	POWER	WT
FWDG	£2409	€2771	490	620	578	1.5kW	63

Premium Range Pizza Ovens

- Thermostatic control up to 480°C with temperature display gauge
- Internal illumination and toughened safety glass viewing window
- Double-glazed door construction for energy efficiency
- Firebrick base for crisp, even cooking of pizza base
- 20 minute audible timer
- Separate controls for top and base of oven compartment
- Twin deck models have independent controls for each deck



Single deck pizza ovens							
MODEL	PRICE £	PRICE €	H	W	D	POWER	WT
PO425	£2033	€2338	365	886	825	3kW	71
Internal dimensions			160	550	535		
*PO430	£2258	€2597	365	966	925	4.2kW	101
Internal dimensions			160	630	640		
*PO630	£2788	€3207	365	1286	925	7.2kW	134
Internal dimensions			160	950	640		

Twin deck pizza ovens							
MODEL	PRICE £	PRICE €	H	W	D	POWER	WT
*PO425-2	£3507	€4034	665	886	825	6kW	114
Internal dimensions			2 x 160	2 x 550	2 x 535		
*PO430-2	£3976	€4573	665	966	925	8.4kW	155
Internal dimensions			2 x 160	2 x 630	2 x 640		
*PO630-2	£4967	€5713	665	1286	925	14.4kW	212
Internal dimensions			2 x 160	2 x 950	2 x 640		

Stacking kits for single deck pizza ovens

MODEL	PRICE £	PRICE €	DESCRIPTION
A PO425/SK	£234	€270	Stacking kit for PO425
A PO430/SK	£254	€293	Stacking kit for PO430
A PO630/SK	£310	€357	Stacking kit for PO630

Floor stands for pizza ovens (self assembly)

MODEL	PRICE £	PRICE €	DESCRIPTION	H	W	D
A PO425/FS	£564	€649	Floor stand for PO425 and PO425-2	900	886	902
A PO430/FS	£618	€711	Floor stand for PO430 and PO430-2	900	966	1002
A PO630/FS	£713	€820	Floor stand for PO630 and PO630-2	900	1286	1002

Standard Range Pizza Ovens

- Single piece firebrick base for crisp base cooking, perfect for all types of pizza
- Separate heat controls for top and base of the compartment
- Fully insulated doors for energy efficiency and safe operation
- Capacity of 4 x 9" (22cm) or 2 x 12" (30cm) pizzas per deck
- Thermostatic control up to 400°C



Single deck pizza ovens							
MODEL	PRICE £	PRICE €	H	W	D	POWER	WT
PO49X	£1472	€1693	320	810	720	2.9kW	69
Internal dimensions			130	550	545		
PO69X	£1830	€2105	320	1010	720	2.9kW	71
Internal dimensions			175	750	545		

Twin deck pizza ovens							
MODEL	PRICE £	PRICE €	H	W	D	POWER	WT
*PO89X	£2486	€2859	565	810	720	5.7kW	93
Internal dimensions			175	550	540		

Floor stands for pizza ovens

MODEL	PRICE £	PRICE €	DESCRIPTION	H	W	D
A POF5	£670	€771	Floor stand for PO49X	1150	810	670
A PO69X/FS	£836	€962	Floor stand for PO69X	1150	1010	670

Floor stands for pizza ovens

MODEL	PRICE £	PRICE €	DESCRIPTION	H	W	D
A POF5	£670	€771	Floor stand for PO89X	1150	810	670

Lincat Specialist

Wall Benches & Centre Tables

- High quality 304 grade stainless steel work surfaces for hygiene and corrosion resistance
- Quick and simple to assemble
- Undershelves for maximum storage space
- Sound deadening design
- Adjustable feet creating level working surface
- Supplied flat-packed for safe and economic transportation



Sink Units

- Double sink
- Sound deadening pads under bowls and drainer
- Tap location - accepts mixer taps (not supplied)
- 38mm waste outlet, plug, chain and overflow
- 250mm deep bowls



Hand Wash Basin

- Constructed from easy to clean stainless steel
- Tap location - accepts 12mm pillar taps (not supplied)
- Waste outlet, plug, chain and overflow
- 105mm deep bowl



Centre tables						
MODEL	PRICE £	PRICE €	H	W	D	WT
L6506CT	£505	€581	900	600	650	24
L6509CT	£565	€650	900	900	650	28
L6512CT	£621	€715	900	1200	650	32
L6515CT	£697	€802	900	1500	650	35
L6518CT	£774	€891	900	1800	650	42

Wall benches 600 series						
MODEL	PRICE £	PRICE €	H	W	D	WT
L6009WB	£565	€650	960	900	600	27
L6012WB	£631	€726	960	1200	600	31
L6015WB	£707	€814	960	1500	600	34
L6018WB	£774	€891	960	1800	600	42

Single sink units						
MODEL	PRICE £	PRICE €	H	W	D	WT
L881 L/H	£1412	€1624	900	1000	600	31
L881 R/H	£1412	€1624	900	1000	600	31

Hand wash basin						
MODEL	PRICE £	PRICE €	H	W	D	WT
HWB1	£253	€291	105	400	350	5

Wall benches 650 series						
MODEL	PRICE £	PRICE €	H	W	D	WT
L6506WB	£538	€619	960	600	650	24
L6509WB	£605	€696	960	900	650	28
L6512WB	£655	€754	960	1200	650	32
L6515WB	£732	€842	960	1500	650	35
L6518WB	£816	€939	960	1800	650	42

Double sink units						
MODEL	PRICE £	PRICE €	H	W	D	WT
L884 L/H	£2230	€2565	900	1500	600	42
L884 R/H	£2230	€2565	900	1500	600	42

Taps

MODEL	PRICE £	PRICE €	DESCRIPTION
A TA49	£127	€147	Pillar taps (pair)

LH - Left hand drainer
RH - Right hand drainer

Taps

MODEL	PRICE £	PRICE €	DESCRIPTION
A TA64	£193	€222	Mixer taps

Key

- H = Height (mm)
- W = Width (mm)
- D = Depth (mm)
- WT = Packed Weight in kg

Wall Cupboards

- Stainless steel construction, durable and easy to clean
- Large capacity and a range of sizes
- Additional shelves available



Wall cupboards						
MODEL	PRICE £	PRICE €	H	W	D	WT
WL4	£649	€747	600	450	300	18
WL6	£732	€842	600	600	300	21
WL7	£816	€939	600	750	300	23
WL9	£883	€1016	600	900	300	30

Additional shelves for cupboards

MODEL	PRICE £	PRICE €	W	D
A WLS4	£28	€33	450	300
A WLS6	£32	€37	600	300
A WLS7	£32	€37	750	300
A WLS9	£35	€41	900	300

Wall Shelves

- Stainless steel construction, durable and easy to clean



Wall shelves

MODEL	PRICE £	PRICE €	W	D
SSH9	£181	€209	900	300
SSH12	£196	€226	1200	300
SSH15	£208	€240	1500	300
SSH18	£247	€285	1800	300

2 YEAR

UK parts and labour warranty

Export parts warranty

on all Lincat products

Slot Toasters

- Unique scissor lifting mechanism helps avoid jamming
- Extra deep toasting slots to accommodate larger slices of bread
- Select fewer slots in periods of low demand for energy efficiency
- High quality components and accurate timer control for reliability
- Removable crumb tray makes cleaning quick and easy



⚡ 4 slot toaster							
MODEL	PRICE £	PRICE €	H	W	D	POWER	WT
LT4X	£328	€378	245	392	220	2.3kW	8



⚡ 6 slot toaster							
MODEL	PRICE £	PRICE €	H	W	D	POWER	WT
LT6X	£409	€471	245	482	220	3kW	11

Conveyor Toaster

- High output from compact unit – ideal for breakfast buffets
- Conveyor speed and upper and lower elements are adjustable for versatile control of browning
- Individually controlled elements for one sided toasting of teacakes, burger buns and other products
- Toasts two slices of bread side-by-side to maximise output



⚡ Conveyor toaster							
MODEL	PRICE £	PRICE €	H	W	D	POWER	WT
CT1	£1356	€1560	398	410	668	2.4kW	23

MODEL	PRICE £	PRICE €	DESCRIPTION
A CT1/CC	£32	€37	Lockable cover for control panel

Fume Filtration Units

- Powerful centrifugal fans draw cooking fumes through a three part filtration system
- Cleansed air is expelled at top rear of unit
- Hinged top panel gives easy access for cleaning and filter maintenance
- Overheat protection system cuts power to fans in the event of a cooking appliance fire
- Note: these units are not designed to extract smoke and are unsuitable for use with gas appliances



Fume filtration unit							
MODEL	PRICE £	PRICE €	H	W	D	POWER	WT
L3	£2299	€2644	560	924	620	0.35kW	41

Suitable for cooking equipment up to 9 kW total consumption

Fume filtration unit							
MODEL	PRICE £	PRICE €	H	W	D	POWER	WT
L4	£2878	€3310	560	1304	620	0.45kW	54

Suitable for cooking equipment up to 14 kW total consumption

Replacement filter components are available; please contact our spare parts sales desk for prices

PANTHER



The flexible Panther Hot Cupboards and Holding Bins keep food in perfect condition.

The Panther range of robust Hot Cupboards includes both static and mobile models, meaning that whether you're looking to transport food, form a servery, or a kitchen pass, you'll find the perfect solution for your needs.

The hygienic cupboards are built for ultimate flexibility. They come in different length options and you can also configure the unit to your exact requirements – by selecting a plain top or bain's marie top as well as adding items such as tray slides, gantries and sneeze screens.

Ideally suited for...

The different sizes available and the ability to modify the hot cupboards means that you're sure to find the right one for your establishment. They might include:



Care homes

The smaller 670 model (670mm wide) is made to fit through narrow doorways, making this model perfect for care homes where plated meals are transported from the kitchen to the residents.



Large restaurants

The larger 800 model (800mm wide) has the capacity to hold and transport high volumes of food. It's perfect for carveries.



Schools

The larger 800 model (800mm wide) is ideal for moving prepared dishes to different locations in the perfect condition. Great for school lunchtimes.



Small pubs and restaurants

The static light duty hot cupboard is designed for establishments where space is at a premium or where budgets are tight.

Hold and transport your meals in the perfect condition with Panther. Perfect food stays perfect.

Benefits at a glance

Static or mobile hot cupboards

- Configurable
- Bains marie or plain top models
- 670mm and 800mm deep
- Fan assisted

Static light duty hot cupboards and Hot holding bins - compact and cost effective

- Robust
- Hygienic

PANTHER

Hot Hold Bins

Keep food warm and in perfect serving condition whilst reducing queues and waste.

- Reduces waste – safely hold food for over 1 hour without shrinkage, or loss of flavour or texture
- Flexible – use with 2 x 1/1GN, 4 x 2/4GN or a combination of these! Additional dividers required for 2/4GN.
- Intuitive digital controls
- Adjustable temperature for each bin
- Independently controlled upper and lower bins, switch off one bin during quieter periods to save energy
- Easy-access open design speeds up service



Unit is supplied without pans

Hot hold bins							
MODEL	PRICE £	PRICE €	H	W	D	POWER	WT
HHB12100	£4090	€4704	375	450	640	1.8kW	34

Accessories

MODEL	PRICE £	PRICE €	DESCRIPTION
A BLA1/1	£48	€56	GN1/1 Slider Cover
A BLA2/4	£48	€56	GN2/4 Slider Cover
A DVD01	£106	€122	Divider for using 2 x GN2/4
A H-PAN01	£119	€137	GN1/1 Food Pan
A H-PAN02	£67	€78	GN1/1 Drain Shelf
A H-PAN04	£87	€101	GN2/4 Long Half Food Pan
A H-PAN05	£36	€42	GN2/4 Long Half Drain Shelf

2 YEAR

UK parts and labour warranty

Export parts warranty

on all Lincat products

PANTHER

Electricity supply requirements for Panther Hot Cupboards depend on configurations (base models + options), please contact our sales office for guidance.

670 Series Hot Cupboards with Plain Top

- Available as static or mobile versions at no additional cost
- Fully 1/1GN compatible hot cupboard
- Fan assisted hot cupboard gives even heat distribution and lower energy usage
- Supplied with two heavy duty multi-section chrome plated rod shelves
- Four shelf positions
- Accurate digital electronic control of the hot cupboard temperature



Standard plain top models								
MODEL	PRICE £	PRICE €	H	W	D	POWER	WT	
P6P2	£1968	€2264	900	980	670	1.5kW	96	
Internal dimensions			432	795	512			
P6P3	£2329	€2679	900	1205	670	1.5kW	104	
Internal dimensions			432	1020	512			
P6P4	£2654	€3053	900	1530	670	2.5kW	124	
Internal dimensions			432	1345	512			
P6P5	£2961	€3406	900	1855	670	2.5kW	150	
Internal dimensions			432	1670	512			

670 Series Hot Cupboards with Bain Marie Top

- Units available to take 2, 3, 4, or 5 x 1/1 GN containers up to 150mm deep, various combinations available
- Thermostatically controlled bain marie top
- Wet or dry heat operation
- Drain tap located inside hot cupboard allows fast and easy draining
- Plus all the benefits of the plain top models



Standard bain marie models								
MODEL	PRICE £	PRICE €	H	W	D	POWER	1/1GN SIZE	WT
P6B2	£2620	€3013	912	980	672	2.6kW	2	101
Internal dimensions			432	795	512			
P6B3	£3013	€3465	912	1205	672	2.8kW	3	111
Internal dimensions			432	1020	512			
*P6B4	£3444	€3961	912	1530	672	4.9kW	4	137
Internal dimensions			432	1345	512			
*P6B5	£3805	€4376	912	1855	672	5.2kW	5	161
Internal dimensions			432	1670	512			

Panther 670 Series hot cupboards are supplied as mobile models with heavy duty castors and one push bar. Please specify legs in lieu of castors and push bar if you require static models at no additional cost.

800 Series Hot Cupboards with Plain Top

- Available as static or mobile versions at no additional cost
- Fully 1/1GN compatible hot cupboard
- Fan assisted hot cupboard gives even heat distribution and lower energy usage
- Supplied with two heavy duty multi-section chrome plated rod shelves
- Four shelf positions
- Accurate digital electronic control of the hot cupboard temperature
- Optional pass through models with removable sliding doors to both sides



800 Series Hot Cupboards with Bain Marie Top

- Units available to take 3, 4, 5 or 6 x 1/1 GN containers up to 150mm deep, various combinations available
- Thermostatically controlled bain marie top
- Wet or dry heat operation
- Drain tap located inside hot cupboard allows fast and easy draining
- Plus all the benefits of the plain top models



Standard plain top models								
MODEL	PRICE £	PRICE €	H	W	D	POWER	WT	
P8P3	£2620	€3013	900	1205	850	1.5kW	133	
Internal dimensions			432	1020	512			
P8P4	£3023	€3477	900	1530	850	2.5kW	166	
Internal dimensions			432	1345	512			
P8P5	£3383	€3891	900	1855	850	2.5kW	201	
Internal dimensions			432	1670	512			
P8P6	£3751	€4314	900	2180	850	2.5kW	213	
Internal dimensions			432	1995	512			

Pass-through plain top models								
MODEL	PRICE £	PRICE €	H	W	D	POWER	WT	
P8P3PT	£3147	€3620	900	1205	850	1.5kW	133	
Internal dimensions			432	1020	512			
P8P4PT	£3607	€4149	900	1530	850	2.5kW	168	
Internal dimensions			432	1345	512			
P8P5PT	£4013	€4615	900	1855	850	2.5kW	201	
Internal dimensions			432	1670	512			
P8P6PT	£4425	€5089	900	2180	850	2.5kW	213	
Internal dimensions			432	1995	512			

Standard bain marie models								
MODEL	PRICE £	PRICE €	H	W	D	POWER	1/1GN SIZE	WT
P8B3	£3337	€3838	912	1205	850	2.8kW	3	118
Internal dimensions			432	1020	512			
*P8B4	£3851	€4429	912	1530	850	4.9kW	4	135
Internal dimensions			432	1345	512			
*P8B5	£4255	€4894	912	1855	850	5.2kW	5	166
Internal dimensions			432	1670	512			
*P8B6	£4669	€5370	912	2180	850	5.2kW	6	197
Internal dimensions			432	1995	512			

Pass-through bain marie models								
MODEL	PRICE £	PRICE €	H	W	D	POWER	1/1GN SIZE	WT
P8B3PT	£3869	€4450	912	1205	850	2.8kW	3	118
Internal dimensions			432	1020	512			
*P8B4PT	£4438	€5104	912	1530	850	4.9kW	4	135
Internal dimensions			432	1345	512			
*P8B5PT	£4887	€5621	912	1855	850	5.2kW	5	166
Internal dimensions			432	1670	512			
*P8B6PT	£5344	€6146	912	2180	850	5.2kW	6	197
Internal dimensions			432	1995	512			

Panther 800 Series hot cupboards are supplied as mobile models with heavy duty castors and one push bar. Please specify legs in lieu of castors and push bar if you require static models at no additional cost.

* Please refer to pages L90 to L91 for electricity supply requirements

PANTHER

Electricity supply requirements for Panther Hot Cupboards depend on configurations (base models + options), please contact our sales office for guidance.

Overshelves

- Heated (with quartz lamps) or ambient models
- Single, double and triple tiered models
- Panther overshelves are factory fitted options and are not available for separate purchase



Single-tier ambient overshelves

MODEL	PRICE £	PRICE €	FOR MODELS*	H	W	D	POWER	WT
A PS2A1	£664	€764	P6B2/P6P2	325	900	320	N/A	8
A PS3A1	£680	€782	P6B3/P6P3/P8B3/P8P3	325	1125	320	N/A	10
A PS4A1	£699	€804	P6B4/P6P4/P8B4/P8P4	325	1450	320	N/A	12
A PS5A1	£721	€830	P6B5/P6P5/P8B5/P8P5	325	1775	320	N/A	14
A PS6A1	£738	€849	P8B6/P8P6	325	2100	320	N/A	17



Two-tier ambient overshelves

MODEL	PRICE £	PRICE €	FOR MODELS*	H	W	D	POWER	WT
A PS2A2	£1060	€1219	P6B2/P6P2	615	900	320	N/A	13
A PS3A2	£1089	€1253	P6B3/P6P3/P8B3/P8P3	615	1125	320	N/A	18
A PS4A2	£1114	€1282	P6B4/P6P4/P8B4/P8P4	615	1450	320	N/A	22
A PS5A2	£1144	€1316	P6B5/P6P5/P8B5/P8P5	615	1775	320	N/A	26
A PS6A2	£1175	€1352	P8B6/P8P6	615	2100	320	N/A	31



Three-tier ambient overshelves

MODEL	PRICE £	PRICE €	FOR MODELS*	H	W	D	POWER	WT
A PS2A3	£1489	€1713	P6B2/P6P2	905	900	320	N/A	19
A PS3A3	£1526	€1755	P6B3/P6P3/P8B3/P8P3	905	1125	320	N/A	25
A PS4A3	£1566	€1801	P6B4/P6P4/P8B4/P8P4	905	1450	320	N/A	32
A PS5A3	£1603	€1844	P6B5/P6P5/P8B5/P8P5	905	1775	320	N/A	39
A PS6A3	£1641	€1888	P8B6/P8P6	905	2100	320	N/A	45

Single-tier heated overshelves

MODEL	PRICE £	PRICE €	FOR MODELS*	H	W	D	POWER	WT
A PS2H1	£1114	€1282	P6B2/P6P2	325	900	320	0.4kW	10
A PS3H1	£1288	€1482	P6B3/P6P3/P8B3/P8P3	325	1125	320	0.6kW	13
A PS4H1	£1458	€1677	P6B4/P6P4/P8B4/P8P4	325	1450	320	0.8kW	17
A PS5H1	£1603	€1844	P6B5/P6P5/P8B5/P8P5	325	1775	320	1kW	20
A PS6H1	£1771	€2037	P8B6/P8P6	325	2100	320	1.2kW	23

Two-tier heated overshelves

MODEL	PRICE £	PRICE €	FOR MODELS*	H	W	D	POWER	WT
A PS2H2	£1895	€2180	P6B2/P6P2	615	900	320	0.8kW	18
A PS3H2	£2198	€2528	P6B3/P6P3/P8B3/P8P3	615	1125	320	1.2kW	24
A PS4H2	£2513	€2890	P6B4/P6P4/P8B4/P8P4	615	1450	320	1.6kW	31
A PS5H2	£2836	€3262	P6B5/P6P5/P8B5/P8P5	615	1775	320	2kW	37
A PS6H2	£3170	€3646	P8B6/P8P6	615	2100	320	2.4kW	44

Three-tier heated overshelves

MODEL	PRICE £	PRICE €	FOR MODELS*	H	W	D	POWER	WT
A PS2H3	£2665	€3065	P6B2/P6P2	905	900	320	1.2kW	23
A PS3H3	£3131	€3601	P6B3/P6P3/P8B3/P8P3	905	1125	320	1.8kW	32
A PS4H3	£3596	€4136	P6B4/P6P4/P8B4/P8P4	905	1450	320	2.4kW	41
A PS5H3	£4090	€4704	P6B5/P6P5/P8B5/P8P5	905	1775	320	3kW	55
A PS6H3	£4581	€5269	P8B6/P8P6	905	2100	320	3.6kW	65

*Overshelves and gantries may also be specified with the equivalent sized pass-through models

Gantries

- Heated (with quartz lamps) or ambient models
- Stylish curved glass sneeze screen
- Panther gantries are factory fitted options and are not available for separate purchase

Ambient Gantries

MODEL	PRICE £	PRICE €	FOR MODELS*	H	W	D	POWER	WT
A PG2A	£824	€948	P6B2/P6P2	520	900	460	N/A	14
A PG3A	£903	€1039	P6B3/P6P3/P8B3/P8P3	520	1125	460	N/A	17
A PG4A	£965	€1110	P6B4/P6P4/P8B4/P8P4	520	1450	460	N/A	21
A PG5A	£1042	€1199	P6B5/P6P5/P8B5/P8P5	520	1775	460	N/A	25

Heated Gantries

MODEL	PRICE £	PRICE €	FOR MODELS*	H	W	D	POWER	WT
A PG2H	£1099	€1264	P6B2/P6P2	520	900	460	0.4kW	14
A PG3H	£1195	€1375	P6B3/P6P3/P8B3/P8P3	520	1125	460	0.6kW	17
A PG4H	£1288	€1482	P6B4/P6P4/P8B4/P8P4	520	1450	460	0.8kW	21
A PG5H	£1383	€1591	P6B5/P6P5/P8B5/P8P5	520	1775	460	1kW	25

Key

H = Height (mm)
W = Width (mm)
D = Depth (mm)
WT = Packed Weight in kg



2 YEAR

UK parts and labour warranty

Export parts warranty

on all Lincat products

670 Series hot cupboards with factory fitted options and all 800 Series products are built to order. Please contact our sales desk for delivery times.

PANTHER

Electricity supply requirements for Panther Hot Cupboards depend on configurations (base models + options), please contact our sales office for guidance.

800 and 670 Series Gastronorm Packs

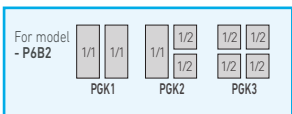

Gastronorm pack configurations are grouped and colour coded to the corresponding model codes. Choose your preferred gastronorm configuration and order the packs as shown in the schematic.

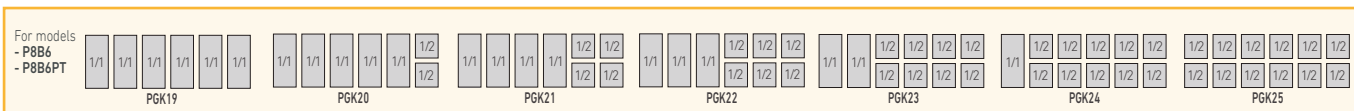
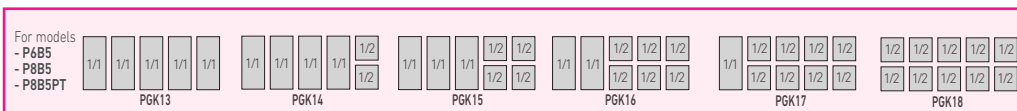
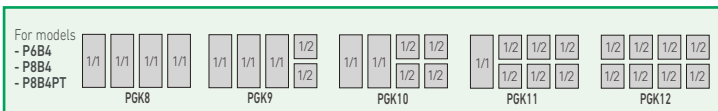
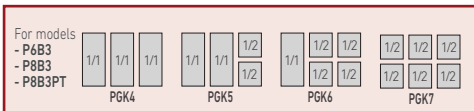

MODEL	PRICE £	PRICE €	DESCRIPTION	1/1GN	1/2 GN
A PGK1	£216	€249	GN Pack 1	2	0
A PGK2	£243	€280	GN Pack 2	1	2
A PGK3	£271	€312	GN Pack 3	0	4
A PGK4	£320	€368	GN Pack 4	3	0
A PGK5	£347	€400	GN Pack 5	2	2
A PGK6	£374	€431	GN Pack 6	1	4
A PGK7	£405	€466	GN Pack 7	0	6
A PGK8	£424	€488	GN Pack 8	4	0
A PGK9	£452	€520	GN Pack 9	3	2
A PGK10	£482	€555	GN Pack 10	2	4
A PGK11	£509	€586	GN Pack 11	1	6
A PGK12	£538	€619	GN Pack 12	0	8
A PGK13	£527	€607	GN Pack 13	5	0
A PGK14	£554	€638	GN Pack 14	4	2
A PGK15	£584	€672	GN Pack 15	3	4
A PGK16	£609	€701	GN Pack 16	2	6
A PGK17	£639	€735	GN Pack 17	1	8
A PGK18	£668	€769	GN Pack 18	0	10
A PGK19	£631	€726	GN Pack 19	6	0
A PGK20	£664	€764	GN Pack 20	5	2
A PGK21	£692	€796	GN Pack 21	4	4
A PGK22	£713	€820	GN Pack 22	3	6
A PGK23	£748	€861	GN Pack 23	2	8
A PGK24	£775	€892	GN Pack 24	1	10
A PGK25	£798	€918	GN Pack 25	0	12

Prices are valid only when purchased with a Panther hot cupboard

All gastronorm containers are 150mm deep

Accessories and Options

800 and 670 Series Accessories

MODEL	PRICE £	PRICE €	DESCRIPTION	Compatible with 800 Series								Compatible with 670 Series										
				P8B3	P8B4	P8B5	P8B6	P8P3	P8P4	P8P5	P8P6	P6B2	P6B3	P6B4	P6B5	P6P2	P6P3	P6P4	P6P5			
A PTS2	£336	€387	Tray slide																			
A PTS3	£369	€425	Tray slide	•																		
A PTS4	£395	€455	Tray slide		•																	
A PTS5	£424	€488	Tray slide			•																
A PTS6	£453	€521	Tray slide				•															
A PDL	£232	€267	Door locks	•	•	•	•	•	•	•	•	•	•	•	•	•	•	•	•	•	•	•
A PCG	£243	€280	Corner bumpers (set of four)	•	•	•	•	•	•	•	•	•	•	•	•	•	•	•	•	•	•	•
A PPB6	£100	€115	Additional push bar																			
A PPB8	£122	€141	Additional push bar	•	•	•	•	•	•	•	•	•	•	•	•	•	•	•	•	•	•	•
A CP16	£294	€339	1/1GN carvery pad insert	•	•	•	•															
A PHTC	£571	€657	1/1GN ceramic panel insert	•	•	•	•															
A PHTG	£571	€657	1/1GN glass panel insert	•	•	•	•															

Accessories and Options

Key

- H = Height (mm)
- W = Width (mm)
- D = Depth (mm)
- WT = Packed Weight in kg

2 YEAR

UK parts and labour warranty

Export parts warranty

on all Lincat products

All optional accessories are also available for 800 Series pass-through models with the exception of tray slides

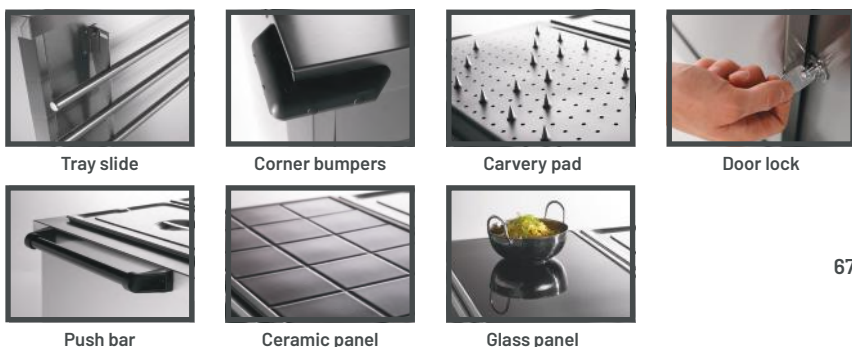

670 Series hot cupboards with factory fitted options and all 800 Series products are built to order. Please contact our sales desk for delivery times.

PANTHER

Electricity supply requirements for Panther Hot Cupboards depend on configurations (base models + options), please contact our sales office for guidance.

SuperPass Series Hot Cupboards

- Fully 1/1 GN compatible hot cupboard, 6 x 1/1 GN in P10SP6PT and 4 x 1/1 GN in the P8SP4PT
- Incorporates a Carter Hoffman Crisp 'N Hold, 2 x 1/1GN bains marie and 2 x water tanks, suitable for boiling vegetables, pasta etc.
- Thermostatically controlled bains marie
- Accurate digital electronic control of water tanks
- Individual drain tap for each water tank at the rear
- Pass through hot cupboard
- Fan assisted hot cupboard for even heat distribution
- Accurate digital electronic control of the hot cupboard temperature
- Three tier heated gantries for pass
- Castors as standard



SuperPass							
MODEL	PRICE £	PRICE €	H	W	D	POWER	WT
*P8SP4PT	£21,461	€24,681	1908	1880	900	11.62kW	230
Internal dimensions			405	1400	490		

2

YEAR
UK parts and labour warranty
Export parts warranty
on all Lincat products

SuperPass							
MODEL	PRICE £	PRICE €	H	W	D	POWER	WT
*P10SP6PT	£26,794	€30,814	1908	2273	1000	15.52kW	270
Internal dimensions			405	2000	825		

Light Duty Series Hot Cupboards

- Fully insulated for enhanced energy-efficiency
- Adjustable thermostatic control to meet food safety regulations**
- Compact, space saving design
- Ideal for food holding and for use as a plate warmer
- ** Excludes PLH45/XP - electronic temperature control preset to 85°C to maintain food temperature



Hot cupboard							
MODEL	PRICE £	PRICE €	H	W	D	POWER	WT
PLH36	£944	€1086	900	360	600	0.75kW	41
Internal dimensions			700	315	530		

Hot cupboard							
MODEL	PRICE £	PRICE €	H	W	D	POWER	WT
PLH45	£989	€1138	900	450	600	0.75kW	47
PLH45/XP	£1001	€1152	900	450	600	1.5kW	45
Internal dimensions			700	405	530		

Hot cupboard							
MODEL	PRICE £	PRICE €	H	W	D	POWER	WT
PLH60	£1187	€1366	900	600	600	1.5kW	60
Internal dimensions			700	555	530		

Hot cupboard							
MODEL	PRICE £	PRICE €	H	W	D	POWER	WT
PLH90	£1416	€1629	900	900	600	2kW	81
Internal dimensions			700	855	530		

* Please refer to pages L90 to L91 for electricity supply requirements



Quality hot water is on tap 24/7 with the FilterFlow range of water boilers.

Easy to use and cheap to run, the reliable FilterFlow range of water boilers offer high output from a minimal footprint.

Whatever your output requirements, you'll find a boiler to cater to your needs. FilterFlow boilers are connected to the main water supply, meaning there's always a steady supply of piping hot water.

Do your employees have to wait in a queue to make a cup of tea at break times? Do you sometimes struggle to deal with a rush of customers asking for teas and coffees all at once? With FilterFlow, these scenarios cease to be a problem.

Ideally suited for...

FilterFlow boilers can provide solutions for a variety of applications where a steady flow of high quality hot water is a must. Places such as:

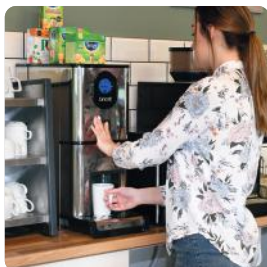

Offices and staff rooms

Break times can be busy times in offices. Especially when everyone wants a cup of tea at the same time. The FilterFlow water boilers efficiently provide hot water on tap, making the whole process much quicker.



Cafés

Do you often get that moment when there's a rush of customers descending on your café at the same time, all in the mood for a relaxing cup of tea or coffee? Serve them quickly and efficiently with the FilterFlow water boiler range.

A reliable supply of quality filtered hot water whenever you need it. There's no need to wait with the FilterFlow range.

Benefits at a glance

- High quality boiling water 24/7
- High output from narrow footprint
- Easy to use
- Cheap to run
- Connected to the mains water supply

Find your new water boiler

With our chart, it's easy to identify the right new boiler to match your needs.

FX Counter Top Automatic Fill Water Boilers

MODEL	EB3FX	EB3FX/PB	EB3FX/WAVE	EB3FX/HC/PB	EB3FX/TT	EB3FX/TALL	EB4FX	EB6FX	EB6TFX
PAGE	L79	L79	L78	L80	L79	L80	L79	L79	L79
Feature	The original Lincat boiler with touchscreen control - variable temp, ECO mode, descale sensor, descale programme and on/off timer	Push button operation ideal for front of house applications	Covid secure, fully touch free operation	Where hot and chilled water is required	Twin taps for twin temperature output, for more than one operator at a time	For operators who only have a three pin plug socket but who experience a high influx of customers in bursts, such as garden centres and farm shops who welcome coach and leisure venues and stadia with intermissions	For high volume requirements	For higher volume requirements	For higher volume requirements with more than one operator at a time
Rapid draw off cups	55	55	55	25 HOT & 60 COLD	45	85	55	90	90
Rapid draw off litres	11	11	11	5 HOT & 12 COLD	2 x 4.5	17	11	18	18
Hourly output cups	155	155	155	140 HOT & 60 COLD	125	155	225	300	300
Hourly output litres	31	31	31	28 HOT & 12 COLD	25	31	45	60	60
Outlet	Tap	Push Button	Wave	Push Button	Twin Tap	Tap	Tap	Tap	Twin Tap
Power Supply									
Installation	UK 13A Plug	UK 13A Plug	UK 13A Plug	UK 13A Plug	UK 13A Plug	UK 13A Plug	1 phase	1 phase	1 phase
Total Power kW	3	3	3	3	3	3	4.5	6	6
Dimensions									
H x W x D mm	596 x 250 x 525	596 x 250 x 525	596 x 250 x 525	596 x 250 x 525	596 x 250 x 525	685 x 250 x 525	596 x 250 x 525	685 x 250 x 525	685 x 250 x 525

Wall Mounted Automatic Fill Water Boilers

MODEL	M3F	WMB3F	M5F	WMB5F	WMB5FX/PB	M7F	WMB7F	M10F
PAGE	L82	L81	L82	L81	L81	L82	L81	L82
Feature	A robust, British-engineered quality water boiler for where high performance is required on a three pin plug and at a competitive price.	With a sleek glass finish, these boilers are ideal for front of house, office kitchens or staff rooms.	A robust, British-engineered quality water boiler for where high performance is required on a three pin plug and at a competitive price.	With a sleek glass finish, these boilers are ideal for front of house, office kitchens or staff rooms.	The WMB5FX/PB offers the benefits of the FX's improved performance, greater efficiencies and convenient touch screen operation in a sleek glass wall mounted design.	A robust, British-engineered quality water boiler for where high performance and higher volume output is required on a 3 pin plug and at a competitive price.	With a sleek glass finish, these boilers are ideal for front of house, larger office kitchens or staff rooms.	A robust, British-engineered quality water boiler for where high performance and higher volume output is required on a 3 pin plug and at a competitive price.
Rapid draw off cups	18	18	28	28	28	38	38	50
Rapid draw off litres	3.5	3.5	5.5	5.5	5.5	7.5	7.5	10
Hourly output cups	140	140	140	140	156	140	140	140
Hourly output litres	28	28	28	28	28	28	28	28
Outlet	Tap	Tap	Tap	Tap	Push Button	Tap	Tap	Tap
Power Supply	UK 13A Plug	1 phase	UK 13A Plug	1 phase	1 phase	UK 13A Plug	1 phase	UK 13A Plug
Total Power kW	3	3	3	3	2.5	3	3	3
Dimensions								
H x W x D mm	398 x 300 x 203	413 x 300 x 184	448 x 340 x 203	462 x 340 x 184	464 x 353 x 218	563 x 340 x 203	462 x 340 x 224	580 x 340 x 296



The 'Zero Contact' Water Boiler Tap Adaptor

A simple low cost solution which will help to protect employees and visitors in the fight against Covid-19. Easily dispense water by pushing back a paddle with the back of a cup, removing all hand contact with the boiler.

- Removes hand contact with boiler – simply push back the paddle with your cup
- Reduces common touch points
- Adapter easily fits over the tap of all models in the EBFX series, and the legacy EB range
- No installation or tools required, simply slip the adaptor over the tap
- Hygienic stainless steel construction – easy to wipe clean
- Fits all Lincat FilterFlow FX Automatic Water Boilers with a tap, plus all legacy EB Automatic Water Boilers



EB Legacy



MODEL	PRICE £	PRICE €	DESCRIPTION
A EBHF01	£114	€132	Hands free water boiler tap adaptor



We are all so aware of potential cross infection and avoiding common touch points, such as taps, are a challenge most of us now face on a daily basis. Any building which has a number of people using its facilities needs a safe and reliable source of hot water for drinks.



Automatic Fill 'Wave' Water Boiler

Dispense water with just the wave of your hand. The FilterFlow Automatic Fill Electric Wave Water Boiler with a built in smart sensor enables fully automatic and touch-free operation to avoid cross infection.

- Ideal for front of house and self service
- Narrow 250mm footprint saves valuable counter space without compromising capacity or performance
- Built-in water filtration system improves water quality and reduces scale build-up. High volume, easy change FilterFlow cartridge
- Easily operated from a large, colour touchscreen display. Menu navigation is quick and easy with the temperature and timer simple to adjust
- Eco setting reduces the volume of boiling water by 50% for quieter periods. The intelligent predictive eco setting learns usage patterns and switches between eco and standard mode to deliver the required hot water output in the most economical way
- 7-day timer allows the boiler to be programmed to switch off overnight or at weekends to conserve energy



FilterFlow automatic fill wave water boiler						
MODEL	PRICE £	PRICE €	H	W	D	POWER WT
EB3FX/WAVE	£1267	€1458	596	250	525	3kW 18
Rapid draw off (hot)						11 litres
Output per hour (hot)						31 litres
						155 cups

MODEL	PRICE £	PRICE €	DESCRIPTION
A BR55	£90	€104	Wall mounting kit
C DP10	£21.45	€24.70	Descaler powder
C FC04	£65.30	€75.10	Replacement filter

2 YEAR

UK parts and labour warranty

Export parts warranty

on all Lincat products



FilterFlow Automatic Water Boilers (Tap Dispense)

- High quality boiling water on tap 24 hours a day
- Built-in water filtration system
- High volume, easy change FilterFlow cartridge
- Large, colour touchscreen display
- Narrow 250mm footprint
- Eco setting reduces the volume of boiling water by 50%
- Intelligent predictive eco setting learns usage patterns and adjusts water volume
- 7-day timer
- Adjustable water temperature from 70°C - 98°C
- Enhanced diagnostics
- Self descale programme to reduce the build-up of scale
- Twin tap version - ideal for the busiest periods



FilterFlow automatic water boiler							
MODEL	PRICE £	PRICE €	H	W	D	POWER	WT
EB3FX	£930	€1070	596	250	525	3kW	16
Rapid draw off			11 litres		55 cups		
Output per hour			31 litres		155 cups		

FilterFlow automatic water boiler							
MODEL	PRICE £	PRICE €	H	W	D	POWER	WT
*EB4FX	£1125	€1294	596	250	525	4.5kW	15
Rapid draw off			11 litres		55 cups		
Output per hour			45 litres		155 cups		

FilterFlow automatic water boiler							
MODEL	PRICE £	PRICE €	H	W	D	POWER	WT
*EB6FX	£1216	€1399	685	250	525	6kW	19
Rapid draw off			18 litres		90 cups		
Output per hour			60 litres		300 cups		

FilterFlow automatic water boiler (twin tap)							
MODEL	PRICE £	PRICE €	H	W	D	POWER	WT
*EB6TFX	£1314	€1512	685	250	525	6kW	19
Rapid draw off			18 litres		90 cups		
Output per hour			60 litres		300 cups		

	MODEL	PRICE £	PRICE €	DESCRIPTION
A	BR55	£90	€104	For models EB3FX and EB4FX
A	BR56	£99	€114	For models EB6FX and EB6TFX
C	FC04	£65.30	€75.10	Filter Cartridge
C	DP10	£21.45	€24.70	Descaler powder

FilterFlow Automatic Water Boiler (Push-Button)

- Convenient push button operation
- Ideal for front of house and self service operations
- Lockable mode prevents water being dispensed without the input of a PIN code - perfect for schools, prisons, care homes and settings with vulnerable individuals
- Plus all the features of the EB3FX

FilterFlow Twin Temperature Automatic Water Boiler (Tap Dispense)

- Tanks can be set to different temperatures - ideal for brewing black teas at 98°C and green teas at 71°C
- High quality boiling water on tap 24 hours a day
- Large colour touchscreen display
- Built-in water filtration system improves water quality and reduces scale build-up
- High volume, easy change FilterFlow cartridge
- Narrow 250mm footprint
- 7-day timer
- Adjustable water temperature - from 70°C - 98°C, ideal for all types of beverage
- Enhanced diagnostics
- Self descale programme to reduce the build-up of scale

FilterFlow large capacity automatic water boiler							
MODEL	PRICE £	PRICE €	H	W	D	POWER	WT
EB3FX/PB	£1173	€1349	596	250	525	3kW	18
Rapid draw off			11 litres		55 cups		
Output per hour			31 litres		155 cups		

	MODEL	PRICE £	PRICE €	DESCRIPTION
A	BR55	£90	€104	Wall mounting kit
C	FC04	£65.30	€75.10	Filter Cartridge
C	DP10	£21.45	€24.70	Descaler powder



FilterFlow large capacity automatic water boiler							
MODEL	PRICE £	PRICE €	H	W	D	POWER	WT
EB3FX/TT	£1327	€1527	596	250	525	3kW	20
Rapid draw off			2 x 4.5 litres		45 cups		
Output per hour			25 litres		125 cups		

	MODEL	PRICE £	PRICE €	DESCRIPTION
A	BR55	£90	€104	Wall mounting kit
C	FC04	£65.30	€75.10	Filter Cartridge
C	DP10	£21.45	€24.70	Descaler powder



* Please refer to pages L90 to L91 for electricity supply requirements



FilterFlow Automatic Water Boiler and Chiller (Push-Button)

- Convenient push button operation, ideal for front of house and self service applications
- Filtered chilled and hot water on tap 24 hours a day
- Space saving and economic - no need for a separate boiler and chiller
- Narrow 250mm footprint saves valuable counter space without compromising capacity or performance
- Built-in water filtration system improves water quality and reduces scale build-up
- High volume, easy change FilterFlow cartridge
- Easily operated from a large, colour touchscreen display. Menu navigation is quick and easy with the temperature and timer simple to adjust
- Enhanced diagnostics identify possible causes. The on screen diagnostic information will enable the engineer to identify the parts needed and repair your water boiler at first visit



FilterFlow automatic water boiler (Hot & Cold)						
MODEL	PRICE £	PRICE €	H	W	D	POWER WT
EB3FX/HC/PB	£2435	€2801	596	250	570	3kW 32
Rapid draw off (hot)					5 litres	25 cups
Rapid draw off (cold)					12 litres	60 cups
Output per hour (hot)					28 litres	140 cups
Output per hour (cold)					12 litres	60 cups

2

YEAR

UK parts and labour warranty
Export parts warranty
on all Lincat products

MODEL	PRICE £	PRICE €	DESCRIPTION
A BR57	£91	€105	Wall mounting kit
C FC04	£65.30	€75.10	Filter Cartridge
C DP10	£21.45	€24.70	Descaler powder



FilterFlow Automatic Water High Capacity Boiler (Tap Dispense)

- For high volume requirements, with rapid draw off of 17 litres
- Ideal for operators that experience a high influx of customers in a short space of time, such as sports stadia, leisure venues, garden centres and farm shops that welcome coach trips
- UK 3 pin plug, removing the need for hard wiring, which means operators can simply plug in and switch on
- All the other great features of our popular EB3FX

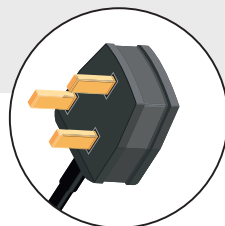

FilterFlow large capacity automatic water boiler						
MODEL	PRICE £	PRICE €	H	W	D	POWER WT
EB3FX/TALL	£1158	€1332	685	250	525	3kW 18.5
Rapid draw off (hot)					17 litres	85 cups
Output per hour (hot)					31 litres	155 cups

MODEL	PRICE £	PRICE €	DESCRIPTION
C FC04	£65.30	€75.10	Filter Cartridge
C DP10	£21.45	€24.70	Descaler powder
S BR56	£99	€114	Wall Bracket

2

YEAR

UK parts and labour warranty
Export parts warranty
on all Lincat products



Wall Mounted, Automatic Water Boilers with Tap Dispense

Introducing the WMB5F (5 litre) and the WMB7F (7 litre) wall mounted automatic water boilers based on our popular 3 litre WMB3F. With a sleek glass finish available in black or white, these boilers are ideal for front of house, office kitchens or staff rooms.

- Exceptionally compact and perfect for locations with limited space
- High quality boiling water on tap 24 hours a day
- Built-in water filtration system improves water quality and reduces scale build-up
- Dispense temperature can be reduced to 70°C perfect for delicate specialty teas
- High volume, easy change FilterFlow cartridge
- Extra room underneath for larger cups, teapots, jugs and airpots to be filled
- Advanced diagnostics with LCD panel showing boiler status
- Cool-to-touch 6mm thick toughened glass fascia to withstand hard knocks
- Require hard wiring to the mains



WMB3F FilterFlow wall mounted automatic water boiler

MODEL	PRICE £	PRICE €	GLASS	H	W	D	POWER	WT
*WMB3F/B	£892	€1026	Black	413	300	185	3kW	11
*WMB3F/W	£892	€1026	White	413	300	185	3kW	11
Rapid draw off			3.5 litres			18 cups		
Output per hour			28 litres			140 cups		

WMB5F FilterFlow wall mounted automatic water boiler

MODEL	PRICE £	PRICE €	GLASS	H	W	D	POWER	WT
*WMB5F/B	£962	€1107	Black	462	340	184	3kW	11
*WMB5F/W	£962	€1107	White	462	340	184	3kW	11
Rapid draw off			5.5 litres			28 cups		
Output per hour			28 litres			140 cups		

WMB7F FilterFlow wall mounted automatic water boiler

MODEL	PRICE £	PRICE €	GLASS	H	W	D	POWER	WT
*WMB7F/B	£1032	€1187	Black	462	340	224	3kW	12
*WMB7F/W	£1032	€1187	White	462	340	224	3kW	12
Rapid draw off			7.5 litres			38 cups		
Output per hour			28 litres			140 cups		

Accessories

MODEL	PRICE £	PRICE €	DESCRIPTION
C FC02	£65.30	€75.10	Filter Cartridge
C DP10	£21.45	€24.70	Descaler powder
S DR72	£229	€264	Drip tray for WMB3F & WMB5F

Accessories

MODEL	PRICE £	PRICE €	DESCRIPTION
C FC02	£65.30	€75.10	Filter Cartridge
C DP10	£21.45	€24.70	Descaler powder
S DR98	£246	€283	Drip tray for WMB7F

Wall Mounted Automatic Boiler with Touch Screen Control and Push Button Dispense

Based on our popular FX Counter Top Automatic Fill Water Boiler series, the WMB5FX/PB offers the benefits of the FX's improved performance, greater efficiencies and convenient touch screen operation in a sleek glass wall mounted design.

- Ideal for self-service and front of house applications
- Easily operated from a large, colour touch-screen display
- High quality boiling water on tap 24 hours a day
- Built-in water filtration system improves water quality and reduces scale build up
- High volume, easy change FilterFlow cartridge
- Adjustable water temperature from 70°- 98°C, ideal for all types of beverage
- Precise electronic temperature control system
- Enhanced multi-level diagnostics
- Easy to clean toughened glass fascia
- Boiler operation can be timed to switch off overnight



WMB5FX/PB Wall Mounted Automatic Boiler with Touch Screen Control and Push Button Dispense

MODEL	PRICE £	PRICE €	H	W	D	POWER	WT
WMB5FX/PB/B	£1354	€1558	464	353	218	2.8kW	14
Rapid draw off			5.5 litres			28 cups	
Output per hour			28 litres			156 cups	

Accessories

MODEL	PRICE £	PRICE €	DESCRIPTION
C FC04	£65.30	€75.10	Filter Cartridge
C DP10	£21.45	€24.70	Descaler powder
S DR97	£246	€283	Drip tray



Wall Mounted Automatic Water Boilers

The M3F, M5F, M7F and M10F provide a **robust, quality water boiler** with a range of features at a **competitive price!**

- Available in 3, 5.5, 8 and 10-litre sizes
- Connected to mains water supply to deliver instant, continuous, high-quality boiling water
- Wall mounted, compact design
- Easy installation – UK 3 pin plug and three screws
- Built-in water filtration system, complete with FilterFlow's popular high-volume easy to change cartridge
- Adjustable water temperature from 70°C - 96°C
- Precise electronic temperature control system
- LCD information panel
- Enhanced multi-level diagnostics
- Easy clean stainless steel finish



Automatic fill wall mounted water boilers									
MODEL	PRICE £	PRICE €	H	W	D	RAPID DRAW OFF	OUTPUT PER HOUR	POWER	WT
M3F	£718	€826	398	300	269	3.5L / 18 cups	28L / 140 cups	3kW	12
M5F	£730	€840	448	340	269	5.5L / 28 cups	28L / 140 cups	3kW	13
M7F	£777	€894	563	340	269	8L / 38 cups	28L / 140 cups	3kW	15
M10F	£952	€1095	580	340	296	10L / 50 cups	28L / 140 cups	3kW	15

MODEL	PRICE £	PRICE €	DESCRIPTION
C FC04	£65.30	€75.10	Filter Cartridge
C DP10	£21.45	€24.70	Descaler powder
A DR94	£246	€283	Drip tray - M3F
A DR95	£246	€283	Drip tray - M5F and M7F
A DR96	£225	€259	Drip tray - M10F

SEAL



Tempt customers to spend more with Seal displays and merchandisers.

You can rely on the Seal displays, merchandisers, cabinets and showcases to hold food in optimum conditions – at all times.

The sleek and elegant designs entice customers to spend more as you can tempt them with your already prepared meals and snacks.

Whether you're looking for a front of house or back of house solution, and whatever the type of food, from hot meats, pizzas and pies, to cold sandwiches and yoghurts, you'll find the perfect model for you in the Seal range.

Ideally suited for...

The Seal range is ideal for anyone who needs a method for holding food at the right temperature while tempting customers to spend more at the same time.



School and college canteens

Keep student meals and snacks in the optimum condition and encourage additional sales.



Hotels

Perfect for showcasing and holding foods during breakfast as well as for other meals.



Sporting venues

Entice customers before, during and after the game with clear and well-designed displays of appetizing food.



Cafés

Keep baked goods and other foods in the perfect condition while tempting your customers to make additional purchases at the checkout.

The Seal range combines the functional - keeping food at the optimum temperature - with an attractive design that can entice customers to make additional purchases.

Benefits at a glance

- Showcase your food and increase sales
- Ambient, refrigerated and heated merchandisers and displays
- Keep food in optimum condition
- Front and back service option
- Reliable
- Sturdy
- Hygienic

SEAL



GRAB & GO!

GRAB & GO!

GRAB & GO!

GRAB & GO!

Hot Air Displays

HAD40 and HAD50

The perfect way to display hot food and generate grab & go sales. The convected hot air system ensures food is not only safe but also kept in prime condition at just the right temperature.



- Maintains the ideal holding temperature of 65°C – 70°C, ideal for all sorts of pre-cooked hot foods, including pizzas, pies and sausage rolls
- Compact 400 and 500mm wide design for where counter space is at a premium
- Food is displayed on four 'easy to remove' tilted shelves within the two compartments
- Hot air curtain at the front minimises heat loss
- Electronic temperature control to within +/-1°C
- Secondary safety limit thermostat
- Stainless steel point of sale holders
- Lighting providing a bright interior with user replaceable light bulb
- Easy clean stainless steel external finish
- Easy clean stainless interior
- Toughened glass sides and front deflectors
- Non-slip feet

Hot air displays							
MODEL	PRICE £	PRICE €	H	W	D	POWER	WT
HAD40	£2474	€2846	845	400	585	2.2kW	49
HAD50	£2518	€2896	845	500	585	2.2kW	57

MODEL	PRICE £	PRICE €	DESCRIPTION
A PSH40	£278	€320	Pizza Shelf insert for HAD40 - set of 4
A PSH50	£278	€320	Pizza Shelf insert for HAD50 - set of 4

GRAB & GO!

GRAB & GO!

GRAB & GO!

GRAB & GO!

Upright Heated Merchandisers

Pie Cabinets

- Robust stainless steel construction
- Minimum food holding temperature of 72°C
- Thermostatic control up to 95°C
- Humidity feature keeps food in perfect condition
- User-replaceable light bulbs



- Stylish, rounded and compact design
- Minimum food holding temperature of 72°C
- Thermostatic control up to 95°C
- Robust stainless steel construction
- Three chrome-plated rod shelves in LPW model and four in LPW/LR model
- Additionally, model LPW/LR offers
 - Two 25-watt diffused switchable lights with user-changeable bulbs for enhanced food presentation
 - Humidity feature to keep food in perfect condition for longer, minimising waste



Upright heated merchandiser with rotating rack								Upright heated merchandiser with static rack									
MODEL	PRICE £	PRICE €	H	W	D	POWER	WT	DOORS	MODEL	PRICE £	PRICE €	H	W	D	POWER	WT	DOORS
UM50	£1652	€1900	783	562	562	1400W	53	1	UM50	£1455	€1674	783	562	562	1400W	54	1
UM50D	£1833	€2108	783	562	562	1400W	51	2	UM50D	£1674	€1926	783	562	562	1400W	54	2

Pie cabinet								Pie cabinet with illumination and humidity feature							
MODEL	PRICE £	PRICE €	H	W	D	POWER	WT	MODEL	PRICE £	PRICE €	H	W	D	POWER	WT
LPW	£735	€846	520	710	330	750W	30	LPW/LR	£850	€978	520	710	330	800W	32

Key

- H = Height (mm)
- W = Width (mm)
- D = Depth (mm)
- WT = Packed Weight in kg

2 YEAR

UK parts and labour warranty
Export parts warranty
on all Lincat products

650 Range Curved Front Heated

- Minimum food holding temperature of 72°C
- Precise thermostatic control up to 95°C with digital display
- Humidity feature prevents food drying out
- Daylight-balanced illumination with easy-change light tubes
- Options for back-service or self-service operation



Heated merchandiser								
MODEL	PRICE £	PRICE €	H	W	D	POWER	WT	
C6H/75B	£2564	€2949	755	750	650	1520W	69	
C6H/75S	£2636	€3032	755	750	650	1520W	67	

Heated merchandiser								
MODEL	PRICE £	PRICE €	H	W	D	POWER	WT	
C6H/100B	£2820	€3243	755	1000	650	2020W	83	
C6H/100S	£2901	€3337	755	1000	650	2020W	82	

650 Range Curved Front Refrigerated

- Holds food at 3°C - 7°C in ambient conditions up to 25°C and 60% relative humidity
- Thermostatic temperature control with digital display
- Daylight-balanced illumination with easy-change light tubes
- Double-glazed for improved energy efficiency and low running costs
- Options for back-service or self-service operation



Refrigerated merchandiser with side mounted power pack										POWER PACK		
MODEL	PRICE £	PRICE €	POWER UNIT	H	W	D	POWER	WT	H	W	D	
C6R/75BU	£4579	€5266	Under	755	750	650	602W	122	270	550	330	
C6R/75SU	£4646	€5343	Under	755	750	650	602W	120	270	550	330	

Refrigerated merchandiser with side mounted power pack										POWER PACK		
MODEL	PRICE £	PRICE €	POWER UNIT	H	W	D	POWER	WT	H	W	D	
C6R/100BU	£4467	€5138	Under	755	1000	650	717W	144	270	550	330	
C6R/100SU	£4579	€5266	Under	755	1000	650	717W	110	270	550	330	

650 Range Rectangular Front Refrigerated

- Holds food at 3°C - 7°C in ambient conditions up to 25°C and 60% relative humidity
- Double-glazed for extra energy efficiency and low running costs
- Thermostatic temperature control with digital display
- Daylight-balanced illumination with easy-change light tubes
- Options for back-service or self-service operation



BACK IN 2023

Refrigerated merchandiser											POWER PACK		
MODEL	PRICE £	PRICE €	POWER UNIT	H	W	D	POWER	WT	H	W	D		
D6R/75B	£4353	€5006	Top	965	750	650	602W	108	250	750	650		
D6R/75S	£4579	€5266	Top	965	750	650	602W	106	250	750	650		

Key

- H = Height (mm)
- W = Width (mm)
- D = Depth (mm)
- WT = Packed Weight in kg



500 Range Heated

- Minimum food holding temperature of 72°C
- Thermostatic control up to 95°C
- Daylight-balanced illumination with easy-change light tubes
- Humidity feature prevents food drying out
- Switchable heat control allows use as an ambient display
- Options for back-service or self-service operation



500 Range Refrigerated

- Holds food at 3°C - 7°C in ambient conditions up to 25°C and 60% relative humidity
- Thermostatic temperature control with digital display
- Daylight-balanced illumination with easy-change light tubes
- Double-glazed front and sides for extra energy efficiency and low running costs
- Option for back-service or self-service operation



Heated merchandiser							
MODEL	PRICE £	PRICE €	H	W	D	POWER	WT
D5H/75B	£1722	€1981	575	750	500	1520W	58
D5H/75S	£1940	€2231	575	750	500	1520W	50

Heated merchandiser							
MODEL	PRICE £	PRICE €	H	W	D	POWER	WT
D5H/100B	£1910	€2197	575	1000	500	2020W	62
D5H/100S	£2088	€2402	575	1000	500	2020W	62

Refrigerated merchandiser							
MODEL	PRICE £	PRICE €	POWER UNIT	H	W	D	POWER WT
D5R/100B	£3421	€3935	Right	575	1000	500	602W 87
D5R/100S	£3626	€4170	Right	575	1000	500	602W 84
Power pack				575	250	500	

Heated Food Display Showcases

- Minimum food holding temperature of 72°C
- Daylight-balanced illumination with easy-change light tubes
- Precise thermostatic control up to 95°C with digital display

- Humidity feature prevents food drying out
- Supplied with 65mm deep 1/1GN containers
- Optional flat base plate



Heated showcase							
MODEL	PRICE £	PRICE €	H	W	D	POWER	WT
SCH785	£2515	€2893	665	785	750	1550W	70

Heated showcase							
MODEL	PRICE £	PRICE €	H	W	D	POWER	WT
SCH1085	£2713	€3120	665	1085	750	2050W	88

MODEL	PRICE £	PRICE €	DESCRIPTION
A BP785	£113	€130	Base plate for SCH785

MODEL	PRICE £	PRICE €	DESCRIPTION
A BP1085	£137	€158	Base plate for SCH1085



Heated Displays with Gantries

- Thermostatic control of base heat
- Minimum food holding temperature of 72°C
- Aluminium surface for energy-efficient heat conduction
- Accepts 1/1GN containers
- Overhead gantry with halogen heat lamps
- Toughened glass sneeze screen for hygiene and safety
- Optional bain marie adaptor holds 2/3GN containers



Heated display with gantry (2 x 1/1 GN)							
MODEL	PRICE £	PRICE €	H	W	D	POWER	WT
LD2	£866	€996	560	790	538	1500W	25

Heated display with gantry (2 x 1/1 GN)							
MODEL	PRICE £	PRICE €	H	W	D	POWER	WT
LD3	£1095	€1260	560	1130	538	2400W	35

Heated display with gantry (4 x 1/1 GN)							
MODEL	PRICE £	PRICE €	H	W	D	POWER	WT
LD4	£1287	€1481	560	1470	538	2750W	40

Bain marie adaptor including GN dishes and lids

MODEL	PRICE £	PRICE €	FOR MODEL	PACK QUANTITY
A LDBM2	£372	€428	LD2	2 x 2/3 GN

Bain marie adaptor including GN dishes and lids

MODEL	PRICE £	PRICE €	FOR MODEL	PACK QUANTITY
A LDBM3	£503	€579	LD3	3 x 2/3 GN

Bain marie adaptor including GN dishes and lids

MODEL	PRICE £	PRICE €	FOR MODEL	PACK QUANTITY
A LDBM4	£606	€697	LD4	4 x 2/3 GN

Heated Display Bases

- Thermostatic control
- Minimum food holding temperature of 72°C
- Aluminium surface for energy-efficient heat conduction
- Accepts 1/1GN containers
- Affordable choice where overhead heat and illumination is not required
- Optional bain marie adaptor holds 2/3GN containers



Heated display base (1 x 1/1 GN)							
MODEL	PRICE £	PRICE €	H	W	D	POWER	WT
HB1	£460	€529	112	380	505	500W	10

Heated display base (3 x 1/1 GN)							
MODEL	PRICE £	PRICE €	H	W	D	POWER	WT
HB3	£622	€716	112	1094	505	1400W	19

Bain marie adaptor including GN dishes and lids

MODEL	PRICE £	PRICE €	SIZE	TO FIT
A HBBM3	£503	€579	3 x 2/3 GN	HB3



Heated display base (2 x 1/1 GN)							
MODEL	PRICE £	PRICE €	H	W	D	POWER	WT
HB2	£539	€620	112	754	505	1000W	14

Heated display base (4 x 1/1 GN)							
MODEL	PRICE £	PRICE €	H	W	D	POWER	WT
HB4	£763	€878	112	1434	505	1750W	24

Bain marie adaptor including GN dishes and lids

MODEL	PRICE £	PRICE €	SIZE	TO FIT
A HBBM2	£376	€433	2 x 2/3 GN	HB2

Bain marie adaptor including GN dishes and lids

MODEL	PRICE £	PRICE €	SIZE	TO FIT
A HBBM4	£628	€723	4 x 2/3 GN	HB4

2 YEAR
UK parts and labour warranty
Export parts warranty
on all Lincat products



Refrigerated Food Display Bars

- Precise thermostatic control with digital display
- Holds food at 3°C-7°C in ambient conditions up to 25°C and 60% relative humidity
- Efficient R134a refrigerant ensures optimum performance

- Well base and side refrigeration ensures even cooling throughout bar length
- Fully welded stainless steel construction
- Stylish low profile design holds 100mm deep gastronorm containers



FDB5 - Food Display Bar with optional back service glass



FDB8 - Food Display Bar with optional stainless steel lid



FDB6 - Food Display Bar with optional self service glass



FDB10 - Food Display Bar with optional back service glass



FDB4 - Food Display Bar with optional back service glass

Food display bars (base units)							
MODEL	PRICE £	PRICE €	H	W	D	POWER	WT
FDB4	£1986	€2284	245	1056	377	175W	27
FDB5	£2021	€2325	245	1222	377	175W	28
FDB6	£2048	€2356	245	1399	377	175W	30
FDB8	£2102	€2418	245	1753	377	175W	34
FDB10	£2139	€2460	245	2107	377	175W	39

Stainless steel lids				
MODEL	PRICE £	PRICE €	TO FIT	
A DBL4	£223	€257	FDB4	
A DBL5	£229	€264	FDB5	
A DBL6	£247	€285	FDB6	
A DBL8	£253	€291	FDB8	
A DBL10	£277	€319	FDB10	

Back service curved glass covers				
MODEL	PRICE £	PRICE €	TO FIT	
A BSG4	£440	€506	FDB4	
A BSG5	£440	€506	FDB5	
A BSG6	£440	€506	FDB6	
A BSG8	£565	€650	FDB8	
A BSG10	£635	€731	FDB10	

Self service curved glass covers				
MODEL	PRICE £	PRICE €	TO FIT	
A SSG4	£470	€541	FDB4	
A SSG5	£470	€541	FDB5	
A SSG6	£488	€562	FDB6	
A SSG8	£574	€661	FDB8	
A SSG10	£660	€759	FDB10	

Wall brackets				
MODEL	PRICE £	PRICE €	TO FIT	
A DBWB	£152/pair	€175/pair	FDB	

Packs of 100mm deep 1/3 GN containers with stainless steel lids for Food Display Bars					
MODEL	PRICE £	PRICE €	FOR MODEL	PACK QUANTITY	
A SGP1004	£317	€365	FDB4	4	
A SGP1005	£392	€451	FDB5	5	
A SGP1006	£460	€529	FDB6	6	
A SGP1008	£604	€695	FDB8	8	
A SGP10010	£752	€865	FDB10	10	

Packs of 100mm deep 1/3 GN containers with transparent acrylic lids for Food Display Bars					
MODEL	PRICE £	PRICE €	FOR MODEL	PACK QUANTITY	
A SGP1004A	£325	€374	FDB4	4	
A SGP1005A	£411	€473	FDB5	5	
A SGP1006A	£476	€548	FDB6	6	
A SGP1008A	£628	€723	FDB8	8	
A SGP10010A	£783	€901	FDB10	10	

Refrigerated Food Preparation Bars

- Precise thermostatic control with digital display
- Holds food at 3°C-7°C in ambient conditions up to 25°C and 60% relative humidity
- Efficient R134a refrigerant ensures optimum performance

- Well base and side refrigeration ensures even cooling throughout bar length
- Robust stainless steel construction
- Large capacity - holds 150mm deep gastronorm containers



FPB5 - Food Preparation Bar with optional back service glass



FPB7 - Food Preparation Bar with optional stainless steel lid

Gastronorm Configurations

Food Preparation Bars



FPB5 (5 x 1/3GN)



FPB7 (7 x 1/3GN)

Food preparation bars (base units)							
MODEL	PRICE £	PRICE €	H	W	D	POWER	WT
FPB5	£1522	€1751	262	1225	377	175W	31
FPB7	£1607	€1849	262	1576	377	175W	35

Stainless steel lids				
MODEL	PRICE £	PRICE €	TO FIT	
A PBL5	£208	€240	FPB5	
A PBL7	£217	€250	FPB7	

Back service square glass covers				
MODEL	PRICE £	PRICE €	TO FIT	
A PBG5	£263	€303	FPB5	
A PBG7	£277	€319	FPB7	

Wall brackets				
MODEL	PRICE £	PRICE €	TO FIT	
A DBWB	£152/pair	€175/pair	FPB	

Packs of 150mm deep 1/3 GN containers with stainless steel lids for Food Preparation Bars					
MODEL	PRICE £	PRICE €	FOR MODEL	PACK QUANTITY	
A SGP1505	£476	€548	FPB5	5	
A SGP1507	£682	€785	FPB7	7	

Packs of 150mm deep 1/3 GN containers with transparent acrylic lids for Food Preparation Bars					
MODEL	PRICE £	PRICE €	FOR MODEL	PACK QUANTITY	
A SGP1505A	£504	€580	FPB5	5	
A SGP1507A	£691	€795	FPB7	7	

Glass Display Cases

- Toughened safety glass throughout with sturdy 10mm thick base glass and strong stainless steel shelf support brackets for extra rigidity
- 6mm thick removable shelves - safe and easy to clean
- Generous 150mm shelf height for versatile display of food and non-food items
- Non-slip rubber feet for extra safety and security



Glass display cases with open backs						
MODEL	PRICE £	PRICE €	H	W	D	WT
GC36	£592	€681	490	607	350	25
GC39	£660	€759	490	907	350	32
GC46	£648	€746	645	607	350	31



Glass display cases with rear sliding doors						
MODEL	PRICE £	PRICE €	H	W	D	WT
GC36D	£652	€750	490	607	350	30
GC39D	£751	€864	490	907	350	40
GC46D	£763	€848	645	607	350	38

Electricity Supply Requirements

Electrical products not listed on this page are supplied for operation on a 230/240v, 13 amp supply.

Brand	Product Code	Power Supply/ Connection Type	Electrical Supply Rating [watts]	Single Phase		Three Phase			
				Amps	Voltage	Amps - Phase 1	Amps - Phase 2	Amps - Phase 3	Voltage
Lincat	AS4	1-phase	4,500	19.60	230	N/A			
Lincat	CO235M	1-phase or 3-phase	4,800	20.5	230	6.9	6.9	6.9	400
Lincat	CO235T	1-phase or 3-phase	4,800	20.5	230	6.9	6.9	6.9	400
Lincat	DF36	1-phase or 3-phase	6,000	26.0	230	13.0	13.0	N/A	400
Lincat	DF39	1-phase or 3-phase	9,000	39.0	230	13.0	13.0	13.0	400
Lincat	DF46	1-phase or 3-phase	6,000	26.0	230	13.0	13.0	N/A	400
Lincat	DF49	1-phase or 3-phase	9,000	39.0	230	13.0	13.0	13.0	400
Lincat	DF612	1-phase or 3-phase	2 x 6,000	2 x 26.0	230	2 x 13.0	2 x 13.0	N/A	400
Lincat	DF618	1-phase or 3-phase	2 x 9,000	2 x 39.0	230	2 x 13.0	2 x 13.0	2 x 13.0	400
Lincat	DF66/ST	1-phase or 3-phase	6,000	26.0	230	13.0	13.0	N/A	400
Lincat	EB4FX	1-phase	4,500	20	230	N/A			
Lincat	EB6FX	1-phase	6,000	26	230	N/A			
Lincat	EB6TFX	1-phase	6,000	26	230	N/A			
Lincat	ECG6	1-phase or 3-phase	8,000	34.8	230	11.6	11.6	11.6	400
Lincat	ECG9	3-phase	13,300	N/A		23.2	23.2	11.6	400
Lincat	ECG9/WT	3-phase	13,300	N/A		23.2	23.2	11.6	400
Lincat	EC09	1-phase or 3-phase	7,500	32.6	230	6.7	6.7	13.0	400
Lincat	ESLR6C	1-phase or 3-phase	11,000	47.8	230	17.4	15.2	15.2	400
Lincat	ESLR9C	3-phase	16,500	N/A		27.9	27.9	15.9	400
Lincat	ESLR9C/SPH	1-phase	13,000	56.5 [1 supp]; 30.4/26.1 [2 supp]	230	N/A			
Lincat	GS4/E	1-phase	3,700	16.1	230	N/A			
Lincat	GS6	1-phase	3,000	13.0	230	N/A			
Lincat	GS6/C	1-phase	3,000	13.0	230	N/A			
Lincat	GS6/T	1-phase or 3-phase	4,000	17.4	230	8.7	8.7	N/A	400
Lincat	GS6/T/E	1-phase or 3-phase	5,600	24.3	230	12.2	12.2	N/A	400
Lincat	GS6/TFR	1-phase or 3-phase	4,000	17.4	230	8.7	8.7	N/A	400
Lincat	GS6/TR	1-phase or 3-phase	4,000	17.4	230	8.7	8.7	N/A	400
Lincat	GS6/TR/E	1-phase or 3-phase	5,600	24.3	230	12.2	12.2	N/A	400
Lincat	GS65	1-phase	4,500	19.6	230	N/A			
Lincat	GS6C/T	1-phase or 3-phase	4,000	17.4	230	8.7	8.7	N/A	400
Lincat	GS7	1-phase or 3-phase	6,000	26.1	230	13.0	13.0	N/A	400
Lincat	GS7/C	1-phase or 3-phase	6,000	26.1	230	13.0	13.0	N/A	400
Lincat	GS7/E	1-phase or 3-phase	7,000	30.4	230	10.1	10.1	10.1	400
Lincat	GS7/R	1-phase or 3-phase	6,000	26.1	230	13.0	13.0	N/A	400
Lincat	GS9	1-phase or 3-phase	8,600	37.4	230	12.1	12.1	13.1	400
Lincat	HT6	1-phase or 3-phase	7,000	30.4	230	8.7	13.0	8.7	400
Lincat	HT7	1-phase or 3-phase	7,000	30.4	230	8.7	13.0	8.7	400
Lincat	J12	1-phase or 3-phase	2 x 6,000	2 x 26.0	230	2 x 13.0	2 x 13.0	N/A	400
Lincat	J18	1-phase or 3-phase	2 x 9,000	2 x 39.0	230	2 x 13.0	2 x 13.0	2 x 13.0	400
Lincat	J6	1-phase or 3-phase	6,000	26.1	230	13.0	13.0	N/A	400
Lincat	J9	1-phase or 3-phase	9,000	39.1	230	13.0	13.0	13.0	400
Lincat	OD8006/N	1-phase or 3-phase	4,032	17.5	230	8.7	8.7	N/A	400
Lincat	OD8006/P	1-phase or 3-phase	4,032	17.8	230	8.7	8.7	N/A	400
Lincat	OD8007/N	1-phase or 3-phase	6,066	26.0	230	9.0	9.0	8.7	400
Lincat	OD8007/P	1-phase or 3-phase	6,066	26.0	230	9.0	9.0	8.7	400
Lincat	OE8008	3-phase	21,600	N/A		31.3	31.3	31.3	400
Lincat	OE8010	3-phase	14,400	N/A		17.4	22.6	22.6	400
Lincat	OE8011	3-phase	15,600	N/A		22.6	22.6	22.6	400
Lincat	OE8012	3-phase	10,400	N/A		22.6	22.6	N/A	400
Lincat	OE8013	3-phase	10,600	N/A		15.3	15.3	15.3	400
Lincat	OE8014	3-phase	21,200	N/A		30.7	30.7	30.7	400
Lincat	OE8015	3-phase	15,400	N/A		26.4	20.5	20.5	400
Lincat	OE8016	3-phase	21,600	N/A		31.3	31.3	31.3	400
Lincat	OE8017	3-phase	24,000	N/A		34.8	34.8	34.8	400
Lincat	OE8018	3-phase	10,600	N/A		15.3	15.3	15.3	400
Lincat	OE8019	3-phase	21,200	N/A		30.7	30.7	30.7	400
Lincat	OE8105	3-phase	14,000	N/A		20.3	20.3	20.3	400
Lincat	OE8105/OP	3-phase	14,000	N/A		20.3	20.3	20.3	400
Lincat	OE8105/OP2	3-phase	14,000	N/A		20.3	20.3	20.3	400
Lincat	OE8108	3-phase	22,000	N/A		31.8 [1 cab]; 2 x 15.9 [2 cab]	31.8 [1 cab]; 2 x 15.9 [2 cab]	N/A	400
Lincat	OE8108/OP	3-phase	22,000	N/A		31.8 [1 cab]; 2 x 15.9 [2 cab]	31.8 [1 cab]; 2 x 15.9 [2 cab]	N/A	400
Lincat	OE8112	3-phase	12,000	N/A		17.5	17.5	17.5	400
Lincat	OE8112/OP	3-phase	12,000	N/A		17.5	17.5	17.5	400
Lincat	OE8113	3-phase	24,000	N/A		34.8 [1 cab]; 2 x 17.4 [2 cab]	34.8 [1 cab]; 2 x 17.4 [2 cab]	N/A	400
Lincat	OE8113/OP	3-phase	24,000	N/A		34.8 [1 cab]; 2 x 17.4 [2 cab]	34.8 [1 cab]; 2 x 17.4 [2 cab]	N/A	400
Lincat	OE8113/OP2	3-phase	24,000	N/A		34.8 [1 cab]; 2 x 17.4 [2 cab]	34.8 [1 cab]; 2 x 17.4 [2 cab]	N/A	400
Lincat	OE8114	3-phase	14,000	N/A		20.3	20.3	20.3	400
Lincat	OE8114/OP	3-phase	14,000	N/A		20.3	20.3	20.3	400
Lincat	OE8205	1-phase or 3-phase	8,000	34.8	230	17.4	17.4	N/A	400
Lincat	OE8205/C	1-phase or 3-phase	8,000	34.8	230	17.4	17.4	N/A	400
Lincat	OE8205/R	1-phase or 3-phase	8,000	34.8	230	17.4	17.4	N/A	400
Lincat	OE8206	1-phase or 3-phase	12,000	52.2	230	17.4	17.4	17.4	400
Lincat	OE8206/C	1-phase or 3-phase	12,000	52.2	230	17.4	17.4	17.4	400
Lincat	OE8206/R	1-phase or 3-phase	12,000	52.2	230	17.4	17.4	17.4	400
Lincat	OE8210	3-phase	17,200	N/A		28.0	28.0	18.0	400
Lincat	OE8210/FR	3-phase	17,200	N/A		28.0	28.0	18.0	400
Lincat	OE8210/R	3-phase	17,200	N/A		28.0	28.0	18.0	400
Lincat	OE8211	3-phase	8,600	N/A		10.8	21.6	10.8	400
Lincat	OE8211/R	3-phase	8,600	N/A		10.8	21.6	10.8	400
Lincat	OE8303	1-phase or 3-phase	5,400	23.50	230	11.8	11.8	N/A	400
Lincat	OE8304	1-phase	4,400	19.10	230	N/A			
Lincat	OE8306	1-phase or 3-phase	4,500	19.60	230	6.5	6.5	6.5	400
Lincat	OE8405	3-phase	8,400	N/A		12.2	12.2	12.2	400
Lincat	OE8406	3-phase	12,400	N/A		18.0	9.0	9.0	400

Electricity Supply Requirements

(page 2 of 2)

Electrical products not listed on this page are supplied for operation on a 230/240v, 13 amp supply.

Brand	Product Code	Power Supply/ Connection Type	Electrical Supply Rating [watts]	Single Phase		Three Phase			
				Amps	Voltage	Amps - Phase 1	Amps - Phase 2	Amps - Phase 3	Voltage
Lincat	OE8413	3-phase	8,400	N/A		11.0	11.0	15.0	400
Lincat	OE8414	3-phase	13,440	N/A		15.0	22.0	22.0	400
Lincat	OE8701	1-phase or 3-phase	6,000	26.1	230	13.0	13.0	N/A	400
Lincat	P10SP6PT	3-phase	16,520	N/A		23.9	23.9	23.9	400
Lincat	P6B4	1-phase	4,950	21.5	230	N/A			
Lincat	P6B5	1-phase	5,200	22.6	230	N/A			
Lincat	P8B4	1-phase	4,900	21.5	230	N/A			
Lincat	P8B4PT	1-phase	4,900	21.5	230	N/A			
Lincat	P8B5	1-phase	5,200	22.6	230	N/A			
Lincat	P8B5PT	1-phase	5,200	22.6	230	N/A			
Lincat	P8B6	1-phase	5,200	22.6	230	N/A			
Lincat	P8B6PT	1-phase	5,200	22.6	230	N/A			
Lincat	P8SP4PT	3-phase	11,620	N/A		17.4	17.4	15.7	400
Lincat	PHEBP80	3-phase	10,000	N/A		15.1	15.1	15.1	380-415
Lincat	PHDR01/N	1-phase or 3-phase	6,000	26.1	230	8.7	8.7	8.7	400
Lincat	PHDR01/P	1-phase or 3-phase	6,000	26.1	230	8.7	8.7	8.7	400
Lincat	PHEAS01	1-phase or 3-phase	4,500	19.50	230	6.5	6.5	6.5	400
Lincat	PHEH01	16A Commando Plug	3,700	17	200	N/A			
Lincat	PHER01	3-phase	17,100	N/A		25.0	25.0	25.0	400
Lincat	PHER01/SPH	1-phase	13,000	56.5 [1 supp.]; 30.4/26.1 [2 supp.]	230	N/A			
Lincat	PHER02	1-phase or 3-phase	11,400	49.6	230	17.4	16.1	16.1	400
Lincat	PO425-2	1-phase or 3-phase	6,000	26.0	230	8.7	8.7	8.7	400
Lincat	PO430	1-phase or 3-phase	4,200	18.3	230	6.1	6.1	6.1	400
Lincat	PO430-2	1-phase or 3-phase	8,400	36.6	230	12.2	12.2	12.2	400
Lincat	PO630	1-phase or 3-phase	7,200	31.3	230	10.4	10.4	10.4	400
Lincat	PO630-2	3-phase	14,400	N/A		20.8	20.8	20.8	400
Lincat	PO89X	1-phase or 3-phase	5,700	24.8	230	7.6	9.6	7.6	400
Lincat	V7/4	1-phase	4,000	17.4	230	N/A			
Lincat	WMB3F/B	1-phase	3,000	13	230	N/A			
Lincat	WMB3F/W	1-phase	3,000	13	230	N/A			
Lincat	WMB5F/B	1-phase	3,000	13	230	N/A			
Lincat	WMB5F/W	1-phase	3,000	13	230	N/A			
Lincat	WMB7F/B	1-phase	3,000	13	230	N/A			
Lincat	WMB7F/W	1-phase	3,000	13	230	N/A			

All weights stated are packed weights.

Warning UK: In accordance with The Gas Safety (Installation and Use Amendment Regulations 1998) gas appliances must be installed by commercial catering equipment engineers certified by the Gas Safe Register. Failure to comply with this will render any non registered installer liable to prosecution and will invalidate the guarantee.

For Sale terms and conditions please visit lincat.co.uk/sale-terms-conditions





PRODUCT RANGE & PRICE LIST



SPECIALISING IN

- FRYERS
- PASTA COOKERS
- CHIP SCUTTLES

Contents



Touch

For those who run the busiest professional kitchens and refuse to compromise on quality.

Professional Free Standing and Drop in Fryers with Automation

Ideally suited for:

- Multi-site operations
- Fast Food/QSR
- Education
- Healthcare
- Retail
- Cloud Kitchens

Why choose Touch?

- All the great features of Precision plus

Why choose Touch?

- QPad intuitive, easy to use touchscreen
- Organise your screen to suit your operation
- 24 user set menu icons, regardless of the operator, the fryer will deliver precisely the same results every time
- Make any change with just a single touch

- Eco mode for energy savings and extended oil life
- Energy, Oil and Data Management giving you control and helping you to make informed commercial decisions
- FriFri Oil Assistant, easily monitor the condition of oil

Find out more on page **F10**



Precision

For the chef who wants superb temperature control for consistently excellent results.

Professional Free Standing and Drop in Fryers

Ideally suited for:

- Chains
- Independents
- Gastronomy
- Education

Why choose Precision?

- Maintains oil to within +/-1°C of your required setting
- Timer with countdown display and buzzer
- Adaptive Cooking - Are there more fries than last time?

- Automatically adjusts cooking times to suit your batch size
- Integral gravity filtration
- Optional LiftFri® automatic basket lifting system
- Optional xFri® pumped oil filtration

Find out more on page **F17**



Super*easy

Outstanding value with no compromise in quality or performance.

Mid-Range Free Standing and Drop in Fryers

Ideally suited for:

- Restaurants
- Hotels
- Education
- Health

Why choose Super Easy?

- Corrosion-resistant 304 grade stainless steel pressed tanks offer superior strength and durability
- A fully rounded profile with radiused corners and a robust hinged element makes cleaning easier and quicker.

- Low watts density element with a large surface area in contact with the oil
- Available with integral gravity filtration
- Optional xFri® integrated oil pump and filtration system

Find out more on page **F23**



profi+

Professional performance from a compact, sturdy counter top fryer.

Professional Counter Top Fryers

Ideally suited for:

- Fine cuisine
- Restaurants

Why choose Profi+?

- A powerful counter top fryer capable of producing up to 25kg of chips per hour
- Highly responsive digital electronic control able to maintain oil to +/-1°C

- Rear-mounted slot-in lid that also acts as a splashback and basket support
- One piece pressed stainless steel tank with rounded corners for increased durability and reduced cleaning times

Find out more on page **F30**

All prices are exclusive of VAT.

UK
Goods are normally delivered free of charge to either the dealers' address or direct within 3 working days. If overnight and/or premium services are required charges will apply.

Export
Goods are priced ex works, export crates POA.

Any units which are built to order or include factory fit options are non-returnable.



frita+

Affordable, durable and efficient – it won't let you down.

Mid-range Counter Top Fryers

Ideally suited for:

- Cafes
- Pubs
- Restaurants

Why choose Frita+?

- A durable, efficient and well designed fryer that won't let you down

- Mechanical thermostat for maintaining oil temperature to within +/-8 °C of the temperature set
- Enhanced operator safety with front mounted control panel

- Rear-mounted slot-in lid that also acts as a splashback and basket support
- One piece pressed stainless steel tank with rounded corners for increased durability and reduced cleaning times

Find out more on page

F32



ECO

The Eco range takes up a minimum of space on work surfaces.

Budget Counter Top Fryers

Ideally suited for:

- Cafes
- Pubs
- Restaurants

Why choose Eco?

- Ideal for the supply of portions of chips, as an occasional fryer or for cooking highly flavoured food
- Mechanical thermostat for maintaining oil temperature to within +/-8 °C
- One piece pressed stainless steel tank with rounded corners
- Lift-out control panel for reduced cleaning times
- Weld-free construction adds strength and durability

Find out more on page

F32



silofrit

Crisp, succulent, piping hot fries every time.

Free Standing, Built In and Counter Top Chip Scuttles

Ideally suited for:

- Quick Service Restaurants
- Restaurants

Why choose Silofrit?

- Crisp, delicious, piping hot fries every time
- Fries are kept piping hot and crispy by the infrared lamp above, as well as the drain plate with attached element beneath
- For added convenience the removable gastronorm and drain plate can be cleaned in the dishwasher
- Manufactured in durable 304 grade stainless steel

Find out more on page

F34



Super*easy pasta

Designed and built to ensure longer life in the harshest of conditions.

Pasta Cooker

Ideally suited for:

- Quick Service Restaurants
- Restaurants

Why choose the Super Easy Pasta Cooker?

- Enables you to cook all types of pasta reliably and consistently with great results
- High outputs of pasta enable you to keep pace with demand, even during peak periods
- Plumbed to fresh water supply and waste for quick, easy filling and drainage of tank
- Superior resistance to punishing salt and starch corrosion with a grade 316 stainless steel single pressed tank and corrosion resistant incoloy heating element

Find out more on page

F35



The FriFri free standing / drop in electric fryer line up

Model	Touch	Precision	Super Easy
Temperature control			
Temperature control	Electronic +/-1°C	Electronic +/-1°C	Mechanical +/-8°C
Temperature range	30-190°C	60-190°C	90-190°C
Temperature increments	1°C	5°C	10°C
Construction			
Stainless steel grade of pressed tank	304	304	304
Stainless steel grade of body	304	304	430
Full tank cover	✓	✓	✓
Stainless steel bucket	✓	✓	✓ if gravity filtration is specified
Allergen control	✓	✓	✓
Element design	Horizontal coiled ultra low watts density element	Horizontal coiled ultra low watts density element	Low watts density element
Reversible door	✓ (Accessory)	✓ (Accessory)	✓ (Accessory)
Protection against water ingress	IPX5	IPX5	IPX5
SOLAS specification feature	Option	Option	✗
Controls			
Operation	QPad touchscreen	Touchpad	Rotary control knob
Programmes	24	1	✗
Adaptive cooking	✓	✓	✗
Eco mode	✓	✗	✗
ColourDue traffic light fryer status	✓	✗	✗
Fat melt cycle	✓	✓	✗
Filtration			
Gravity filtration	✓	✓	Option
xFri [®] - integrated oil pump and filtration system	Option	Option	Option
LiftFri [®] - the automatic basket lifting system	Option	Option	✗
Management Tools			
Oil management	✓	✗	✗
Energy management	✓	✗	✗
Data management	✓	✗	✗
USB for updates, configuring, cloning menu, sharing	✓	✗	✗

Essential Features at a glance

Throughout the price list you will see various icons outlining the features of each FriFri model. Below is an explanation to help you identify each icon.

						
Electronic Temperature Control	Thermostatic Temperature Control	Touchscreen Programmable Control	xFri [®] Pumped Oil Filtration Option	Gravity-fed Oil Filtration	SOLAS Specification Option	LiftFri [®] Automatic Basket Lift Option
						
Horizontally Coiled Elements	Adaptive Cooking	Data Management	Oil Management	Timer	Temperature View	Eco Mode
						
Allergen Control	Rotary Control Front	Rotary Control Rear	Touchpad Control			

The Frying Challenge



Consistency and Quality of Food

Consistency is a crucial element for any foodservice operation to maintain not only a great reputation but also returning customers. The cooking equipment specified plays a critical role in this for any operation, large or small.



Food Wasteage

Between 33-50% of all food produced globally is never eaten, and the value of this wasted food is worth over \$1 trillion.

Not only are all of the resources that went into creating the uneaten food wasted but when food waste goes to landfill, it decomposes and creates methane, which is 23x more deadly than carbon dioxide.



Oil Usage

The most costly ongoing expense when operating a professional fryer is the cooking oil.

Reducing the amount of oil you use is the most cost-effective way of dealing with it. This is also the best option for the environment.



Energy Usage

Energy consumption in foodservice operation has always been high. With energy costs increasing the hospitality industry needs to adapt to reduce energy use and carbon emissions.



Limited Kitchen Space

Commercial kitchens are getting smaller. Around the world, foodservice operations are increasing profitability by shrinking kitchens and dedicating more space to front-of-house. Many new food concepts, such as pop-up restaurants and food trucks, have limited space.



Dietary Requirements and Restrictions

Meeting individual dietary requirements is a growing challenge and can be both costly to the health of your customers and also your reputation if you get it wrong. Food allergies and intolerances are at an all-time high, and as we become more multicultural as a society there is a need to cater to religious and cultural diets as well.



Consistency & Quality of Food

Quality



Horizontal Coiled Elements



Electronic Temperature Control



Adaptive Cooking



LiftFri[®] Automatic Basket Lift Option

ColourCue



Success ultimately depends on the quality and consistency of the food you produce. Deliver incredibly accurate and uniform cooking every time.

FriFri is your new kitchen assistant, helping you to deliver quality results every time.

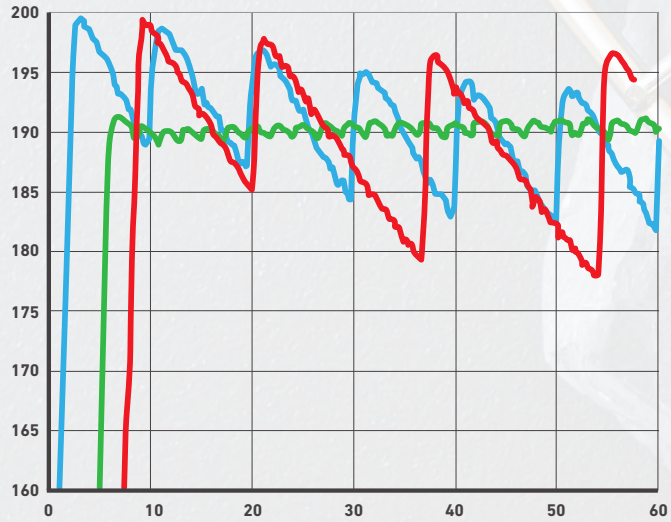

— Super Easy — Precision & Touch — Standard Electric Fryer

That all-important crunch!

Electronic temperature control, powerful elements and fast recovery, maintain oil to within $\pm 1^\circ\text{C}$ of your required setting. This prevents food from absorbing excess oil and ensures that it has that all important crunch!

Keeping your oil in peak condition!

FriFri Oil Assistant and xFri[®] pumped oil filtration enables you to easily monitor the condition of oil with the on-screen oil status bar. When prompted filter the oil even while its still hot, mid service if necessary, and resume frying in under five minutes. It is so quick and easy there is no excuse not to!

One touch perfect food!

With 24 programmed icon driven menu items, regardless of the operator, at one touch, deliver precisely the same results every time.

Are there more fries than last time?

Adaptive cooking automatically adjusts the cooking times to suit your batch size ensuring you never serve undercooked food.

Raising food to the next level

Perfect for kitchens where you don't have time for constant supervision, LiftFri[®] automatic basket lifting system lifts food at the end of the cycle to prevent overcooking.

Easy-View Traffic Light Status—ColourCue

Great for busy and noisy kitchens, ColourCue shows you the status of your fryer at a glance: **red** - attention required such as unload; **amber** - pre-heating; **green** - ready to fry.

Data driven quality

For the ultimate repeatable results view your fryer usage data - hours of operation coupled with the number of cook and filter cycles.

Consistency across sites

Ensure consistent, great quality results across multiple sites, configure and clone your menu easily via USB.

FriFri has been offering the same high quality to its customers for over 70 years



Limited Kitchen Space

Dietary Requirements and Restrictions

Design

A fryer that fits in perfectly with your kitchen and your needs

Deliver big in a small space!

Offering high output from minimal footprint, with models from just 200mm wide, FriFri work wonders even in limited spaces.

FriFri - build your perfect fryer!

There is a FriFri for every type of foodservice operation; from hospitals to food trucks, to ships. From 200mm to 600mm wide, free standing on legs or castors, drop in or SOLAS, there is a fryer for you!

And it doesn't end there! Customise your fryer with a choice of power ratings, and optional features such as basket lifts and pumped filtration.

Just see our Fryer Designer below for all the options available to you!

Operation at a level to meet your needs

FriFri can be as automated as you need to support your operation, whether you require easy one Touch icon driven operation or you want to

be more hands on with your frying, there is a FriFri fryer to support your kitchen set up.

Superior build

Corrosion-resistant 304 grade stainless steel pressed tanks offer superior strength and durability - we are so confident in the life of our tanks that they come with a 10 year warranty. A fully rounded profile with radiused corners and a robust hinged element makes cleaning easier and quicker.

Safety first

Drainage for our integral filtration system is through the body of the fryer to a quick release bucket, safe and mess free. A stainless steel bucket collects filtered oil housed within the cabinet for returning to the tank.

The xFri® integrated oil pump removes the need to manually return oil to the tank or have any contact with the hot oil, reducing the risk of spillages and accidents.

Optimum allergen control

Supplied with separate filtration systems and buckets, twin and triple tank models provide completely segregated gravity filtration for optimum allergen control or to cater for dietary preferences. To compliment this, separate xFri® pumps can be specified to achieve segregated pumped filtration.

The optional Food Segregation Management Pack (FSM) enables components and baskets which can be swapped to be colour-coded to stop them being mixed-up.

A future proofed investment

With easy to apply USB updates.

There are 135 base FriFri models for you to configure, creating 1000's of possible solutions

Fryer Designer

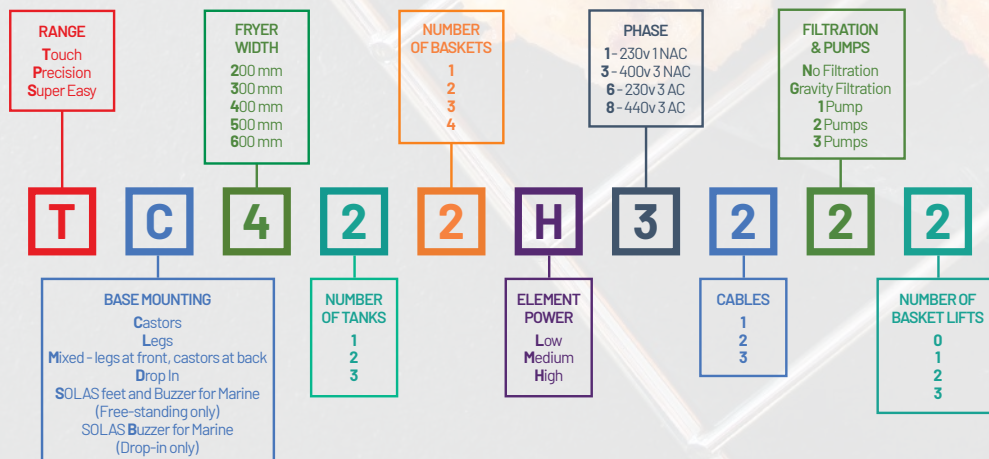



Energy Usage Food Wastage Oil Usage



Eco

FriFri brings together a number of features to help you deliver your eco goals; reducing energy usage, minimising food waste and limiting oil usage.

Great delivery

A compact tank design and efficient cool zone guarantees reduced oil usage, fast heat up and a high output to oil ratio.

Fast recovery

With a greater surface contact with the oil, unique horizontally coiled elements coupled with electronic temperature control together deliver energy efficiency and faster recovery.

Eco mode

Utilising the eco mode, if the fryer is inactive for the a set period of time, it will automatically reduce to a user defined temperature. This not only delivers energy savings and extends the life of the oil and elements, it also makes for a cooler, more comfortable working environment for staff.

Insulation

Fully insulated tanks reduce heat loss.

Reduce oil usage

Extreme temperatures and carbonised food debris are two major contributors in oil degradation. Tight temperature control and the dual filtration system combined with the eco mode prolongs oil life, reduces oil usage and the volume of waste oil.

Cook what you need, when you need it

Its not just the food waste created from cooking more food than is needed, it is also the energy, oil and labour required to produce it. To minimise waste a fryer with multiple baskets can be used to fry small batches simultaneously or twin and triple tank fryers can be used to cook portions requiring different temperatures.

Zero waste just perfectly cooked food

Adaptive cooking will automatically adjust cooking times to suit your batch size to make sure you are not serving undercooked food. LiftFri® automatic basket lifting system will ensure food is not overcooked.

Sustainable design from cradle to grave

Pressed tanks remove the environmental costs of welding and the weaknesses associated with welds and joins. We are so confident in the life of our pressed tanks that they come with a 10 year warranty.

FriFri electric fryers are up to 35% more energy-efficient than a typical gas fryer



Energy Usage Oil Usage

Oil



Success ultimately depends on the quality and consistency of the food you produce. The three enemies of oil - heat, carbon build up and oxygen - can damage oil, affecting the texture, taste and overall flavour of the food you produce. These enemies will also reduce the life of your oil, increasing your oil purchase and disposal costs.

Enemy 1 - Extreme temperatures

FriFri's heating elements have a larger surface area in contact with the oil. Gentle heat distribution across the oil's surface prevents the oil from scorching and ultimately degrading. This, together with tight temperature control ensures extended oil life.

The fat melt cycle for operations using solid fat guards against oil burn in localised areas. The elements pulse melting the fat gently.

Enemy 2 - Carbonised debris

During frying, food pieces break off, eventually becoming burnt carbonised debris. If you continue

using the oil it will affect the taste and appearance of food.

Our integral filtration system extends oil life by up to 75% saving you money on oil purchase and disposal costs. The dual filter system removes debris and carbonised particles.

Easily monitor the condition of oil with the on-screen oil status bar, once the user set life cycle has been reached Oil Assistant will prompt to drain and filter the oil.

The xFri® Integrated oil pump will filter the oil at the touch of a button, even while it's still hot, mid-service if necessary, and resume frying in under five minutes, making oil changes easy and hassle free.

Enemy 3 - Oxygen

FriFri fryers are supplied with lids so tanks can be covered when not in use.

Our integral filtration system extends oil life by up to 75% reducing oil usage



As standard



Electronic Temperature Control



Touchscreen Programmable Controls



Adaptive Cooking



Oil Management



Eco Mode



Gravity-fed Oil Filtration



Data Management



Horizontally Coiled Elements



Allergen Control

Optional



xFry[®] Pumped Oil Filtration Option



LiftFry[®] Automatic Basket Lift Option



SOLAS Specification Option

Touch

For those who run the busiest professional kitchens and refuse to compromise on quality, Touch is your newest kitchen assistant, helping you to deliver quality results every time.

Ideally suited for use in



Multi-site operations



Fast Food/ QSR



Education



Healthcare



Retail



Cloud Kitchens



QPad

Organise your screen to suit your operation. In the recipe manager, Touch enables you to easily set up and position 24 programmed icon driven menu items. Once set each menu icon regardless of the operator, will deliver precisely the same results every time at just one touch!

The 4.3" QPad is intuitive, easy to use and provides the wider functionality and greater control that only a touchscreen can deliver. Make any change with just a single touch.



Energy Management

Visibility into energy usage and managing energy costs has never been more critical. Touch puts you in control and helps you understand your energy usage. Customise the eco settings by defining the optimum time out and temperature to suit your operation. View where you can make savings with detailed analysis of the fryer's energy usage over the last 8 hours, 24 hours, 7 days and 28 days.



Future Proof Compact Design

Invest in the future of your business with a Touch fryer. With superior construction, an industry leading high output from minimal footprint, and with easy to apply USB software updates, Touch will ensure happy, satisfied customers for many years to come.



ColourCue

Easy-View Traffic Light Status - great for busy and noisy kitchens, ColourCue shows you the status of your fryer at a glance: **red** - attention required such as unload; **amber** - pre-heating; **green** - ready to fry.

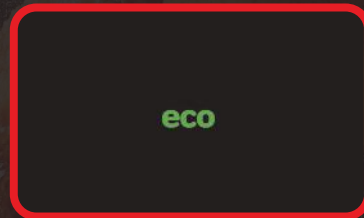

eco mode

Eco mode not only delivers energy savings and extends the life of the oil and elements, it also makes for a cooler, more comfortable working environment for staff.



Adaptive Cooking

Are there more fries than last time? Automatically adjust cooking times to suit your batch size ensuring you never serve undercooked food.

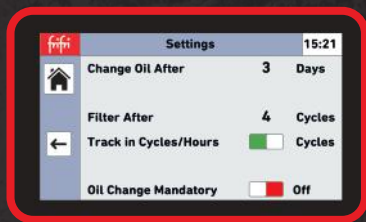

Data Management

Data driven quality. For the ultimate repeatable results view your fryer usage data hours of operation coupled with the number of cook and filter cycles. For multi-site operations configure and clone your menu easily via USB.

Oil Management

The most costly ongoing expense when operating a professional fryer is the cooking oil. Touch gives you complete control in managing your oil usage - specify how often, in cook cycles or hours the oil should be filtered. And to help you make informed commercial decisions about your oil usage it provides insight into how often the oil has been filtered and changed.

Oil Assistant

FriFri Oil Assistant enables you to easily monitor the condition of oil with the on-screen oil status bar.



Touch 211



Touch 311



Touch 633

Optional



Touch 422 built-in



xFri® Pumped Oil Filtration Option

xFri® filters oil at the push of a button and returns the cleaned oil to the tank. You can filter the oil safely while it's still hot, mid-service if necessary, and resume frying in under five minutes.



Allergen Control

For optimum oil segregation, fryers with two or three tanks can be supplied with separate oil pumps.











LiftFri® Automatic Basket Lift Option

Great for kitchens where you don't have time for constant supervision, LiftFri® automatic basket lifting system lifts food at the end of the cycle to prevent overcooking.



For the operator who needs automation

Touch

As standard

- 
Electronic Temperature Control
- 
Touchscreen Programmable Controls
- 
Adaptive Cooking
- 
Oil Management
- 
Eco Mode
- 
Gravity-fed Oil Filtration
- 
Data Management
- 
Horizontally Coiled Elements
- 
Allergen Control

Optional

- 
xFri[®] Pumped Oil Filtration Option
- 
LiftFri[®] Automatic Basket Lift Option
- 
SOLAS Specification Option

Touch Single Tank Free Standing Fryers



† 411 single basket version available

211 Single tank electric fryer (200mm wide)

OIL CAPACITY	NO. OF TANKS	NO. OF BASKETS	DIMENSIONS (mm)			NET WT
			H	W	D	
7.5-9 L	1	1	994	197.5	650	47

311 Single tank electric fryer (300mm wide)

OIL CAPACITY	NO. OF TANKS	NO. OF BASKETS	DIMENSIONS (mm)			NET WT
			H	W	D	
12.5-14.5 L	1	1 (2) ^{***}	994	297.5	650	56

412 Single tank electric fryer (400mm wide)

OIL CAPACITY	NO. OF TANKS	NO. OF BASKETS	DIMENSIONS (mm)			NET WT
			H	W	D	
17-20.5 L	1	2 (1) ^{***}	994	397.5	650	69

MODEL	PRICE £	PRICE €	POWER	OUTPUT /HR (kg) ^{**}	PHASE	SUPPLY CABLES
*TL211L31G0	£4703	€5409	7.5kW	18	3	1
*TL211L11G0	£4703	€5409	7.5kW	18	1	1
*TL211M31G0	£4761	€5476	9kW	20	3	1
*TL211M11G0	£4761	€5476	9kW	20	1	1
*TL211H31G0	£4825	€5549	11kW	22	3	1

MODEL	PRICE £	PRICE €	POWER	OUTPUT /HR (kg) ^{**}	PHASE	SUPPLY CABLES
*TL311L31G0	£5220	€6003	11.4kW	28.5	3	1
*TL311H31G0	£5295	€6090	15kW	32	3	1

MODEL	PRICE £	PRICE €	POWER	OUTPUT /HR (kg) ^{**}	PHASE	SUPPLY CABLES
*TL412L31G0	£6012	€6914	15kW	36	3	1
*TL412M31G0	£6129	€7049	18kW	40	3	1
*TL412H31G0	£6250	€7188	22kW	44	3	1

	PRICE £	PRICE €	DESCRIPTION
O*	£2271	€2612	Single oil return pump
O*	£1620	€1863	Single auto basket lift
O*	£274	€316	SOLAS option for single tank free-standing

	PRICE £	PRICE €	DESCRIPTION
O*	£2271	€2612	Single oil return pump
O*	£1620	€1863	Single auto basket lift
O*	£173	€199	Two rear castors (fixed)
O*	£346	€398	Four castors (fixed castors at rear)
O*	£274	€316	SOLAS option for single tank free-standing

	PRICE £	PRICE €	DESCRIPTION
O*	£2271	€2612	Single oil return pump
O*	£1620	€1863	Single auto basket lift
O*	£3238	€3724	Twin auto basket lift
O*	£173	€199	Two rear castors (fixed)
O*	£346	€398	Four castors (fixed castors at rear)
O*	£274	€316	SOLAS option for single tank free-standing

MODEL	PRICE £	PRICE €	DESCRIPTION
A FRIFRI/USB	£28	€33	USB Stick

MODEL	PRICE £	PRICE €	DESCRIPTION
A FZ301093	£126	€145	Small baskets for 300mm wide single tank
A FRIFRI/USB	£28	€33	USB Stick

MODEL	PRICE £	PRICE €	DESCRIPTION
A FZ411048	£167	€193	Large basket for 400mm wide single tank
A FRIFRI/USB	£28	€33	USB Stick

** 7mm Frozen Fries

*** No. of baskets shown in brackets are an available option. Please call for more details

O* Factory fitted option please request at point of ordering

† 412 pricing applies

* Please refer to pages F36 to F37 for electricity supply requirements



Fryer Designer

Touch

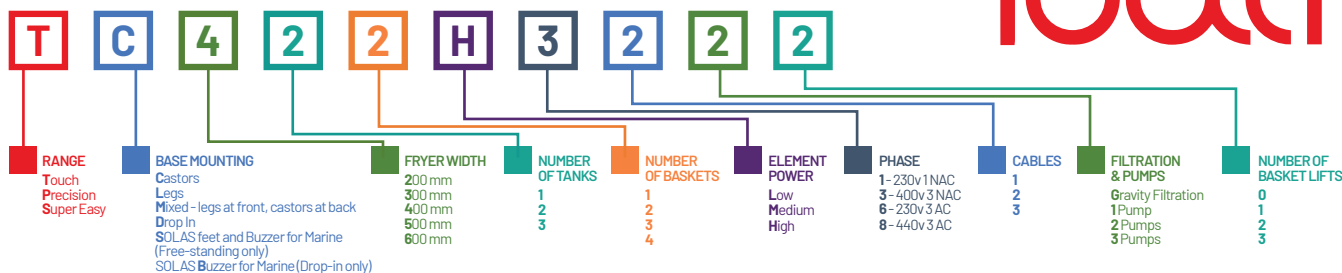

The models in the table are for base models supplied on legs, without pumped oil filtration or basket lifts.

Do you want an alternative configuration of baskets? **How many** supply cables would you like?
Do you require chargeable add on items such as castors and pumped oil filtration?

Please use our Fryer Designer to create your bespoke code. If you would like help to create code please **call us on 01522 875500**.

Touch Twin Tank Free Standing Fryers

Touch Triple Tank Free Standing Fryers



600mm wide triple tank fryer
EXCLUSIVE TO FRIFRI
• Allergen Control
• Flexibility

422 Twin tank electric fryer (400mm wide)

OIL CAPACITY	NO. OF TANKS	NO. OF BASKETS	DIMENSIONS (mm)			NET WT
			H	W	D	
2 x 7.5-9L	2	2	994	397.5	650	79

622 Twin tank electric fryer (600mm wide)

OIL CAPACITY	NO. OF TANKS	NO. OF BASKETS	DIMENSIONS (mm)			NET WT
			H	W	D	
2 x 12.5-14.5L	2	2 (3,4)***	994	592	650	99

633 Triple tank electric fryer (600mm wide)

OIL CAPACITY	NO. OF TANKS	NO. OF BASKETS	DIMENSIONS (mm)			NET WT
			H	W	D	
3 x 7.5-9L	3	3	994	592	650	99

MODEL	PRICE £	PRICE €	POWER	OUTPUT /HR (kg)**	PHASE	SUPPLY CABLES
*TL422L32G0	£8875	€10,207	2x7.5kW	2 x 18	3	2
*TL422L12G0	£8875	€10,207	2x7.5kW	2 x 18	1	2
*TL422M32G0	£8999	€10,349	2 x 9kW	2 x 20	3	2
*TL422M12G0	£8999	€10,349	2 x 9kW	2 x 20	1	2
*TL422H32G0	£9121	€10,490	2 x 11kW	2 x 22	3	2

MODEL	PRICE £	PRICE €	POWER	OUTPUT /HR (kg)**	PHASE	SUPPLY CABLES
*TL622L32G0	£10,180	€11,707	2x11.4kW	2x26.5	3	2
*TL622H32G0	£10,329	€11,879	2 x 15kW	2x26.5	3	2

MODEL	PRICE £	PRICE €	POWER	OUTPUT /HR (kg)**	PHASE	SUPPLY CABLES
TL633L31G0	£13,457	€15,476	3x7.5kW	3 x 18	3	1
TL633L33G0	£13,457	€15,476	3x7.5kW	3 x 18	3	3
TL633L13G0	£13,457	€15,476	3x7.5kW	3 x 18	1	3
TL633M31G0	£13,539	€15,570	3 x 9kW	3 x 20	3	1
TL633M33G0	£13,539	€15,570	3 x 9kW	3 x 20	3	3
TL633M13G0	£13,539	€15,570	3 x 9kW	3 x 20	1	3

	PRICE £	PRICE €	DESCRIPTION
0*	£2271	€2612	Single oil return pump
0*	£4537	€5218	Twin oil return pump
0*	£1620	€1863	Single auto basket lift
0*	£3238	€3724	Twin auto basket lift
0*	£173	€199	Two rear castors (fixed)
0*	£346	€398	Four castors (fixed castors at rear)
0*	£445	€512	SOLAS option for twin tank free-standing

	PRICE £	PRICE €	DESCRIPTION
0*	£2271	€2612	Single oil return pump
0*	£4537	€5218	Twin oil return pump
0*	£1620	€1863	Single auto basket lift
0*	£3238	€3724	Twin auto basket lift
0*	£173	€199	Two rear castors (fixed)
0*	£346	€398	Four castors (fixed castors at rear)
0*	£445	€512	SOLAS option for twin tank free-standing

	PRICE £	PRICE €	DESCRIPTION
0*	£2271	€2612	Single oil return pump
0*	£6585	€7573	Triple oil return pump
0*	£1620	€1863	Single auto basket lift
0*	£3238	€3724	Twin auto basket lift
0*	£5032	€5787	Triple auto basket lift
0*	£173	€199	Two rear castors (fixed)
0*	£346	€398	Four castors (fixed castors at rear)
0*	£615	€708	SOLAS option for triple tank free-standing

MODEL	PRICE £	PRICE €	DESCRIPTION
A FRIFRI/USB	£28	€33	USB Stick

MODEL	PRICE £	PRICE €	DESCRIPTION
A FZ301093	£126	€145	Small baskets for 600mm wide twin tank
A FRIFRI/USB	£28	€33	USB Stick

MODEL	PRICE £	PRICE €	DESCRIPTION
A FRIFRI/USB	£28	€33	USB Stick

** 7mm Frozen Fries

*** No. of baskets shown in brackets are an available option. Please call for more details

0* Factory fitted option please request at point of ordering

* Please refer to pages F36 to F37 for electricity supply requirements

Touch

As standard

- Electronic Temperature Control
- Touchscreen Programmable Controls
- Adaptive Cooking
- Oil Management
- Eco Mode
- Gravity-fed Oil Filtration
- Data Management
- Horizontally Coiled Elements
- Allergen Control

Optional

- xFri[®] Pumped Oil Filtration Option
- LiftFri[®] Automatic Basket Lift Option
- SOLAS Specification Option

Touch Single Tank Drop In Fryers



211 Single tank electric fryer (200mm wide)

OIL CAPACITY	NO. OF TANKS	NO. OF BASKETS	DIMENSIONS (mm)			NET WT
			H	W	D	
7.5-9 L	1	1	809	197.5	630	40

311 Single tank electric fryer (300mm wide)

OIL CAPACITY	NO. OF TANKS	NO. OF BASKETS	DIMENSIONS (mm)			NET WT
			H	W	D	
12.5-14.5 L	1	1 (2)***	809	297.5	630	47

412 Single tank electric fryer (400mm wide)

OIL CAPACITY	NO. OF TANKS	NO. OF BASKETS	DIMENSIONS (mm)			NET WT
			H	W	D	
17-20.5 L	1	2 (1)***	809	397.5	630	62

MODEL	PRICE £	PRICE €	POWER	OUTPUT /HR (kg)**	PHASE	SUPPLY CABLES
*TD211L31G0	£4609	€5301	7.5kW	18	3	1
*TD211L11G0	£4609	€5301	7.5kW	18	1	1
*TD211M31G0	£4666	€5366	9kW	20	3	1
*TD211M11G0	£4666	€5366	9kW	20	1	1
*TD211H31G0	£4729	€5439	11kW	22	3	1

MODEL	PRICE £	PRICE €	POWER	OUTPUT /HR (kg)**	PHASE	SUPPLY CABLES
*TD311L31G0	£5103	€5869	11.4kW	28.5	3	1
*TD311H31G0	£5177	€5954	15kW	32	3	1

MODEL	PRICE £	PRICE €	POWER	OUTPUT /HR (kg)**	PHASE	SUPPLY CABLES
*TD412L31G0	£5868	€6749	15kW	36	3	1
*TD412M31G0	£5987	€6886	18kW	40	3	1
*TD412H31G0	£6105	€7021	22kW	44	3	1

	PRICE £	PRICE €	DESCRIPTION
O*	£2271	€2612	Single oil return pump
O*	£1620	€1863	Single auto basket lift
O*	£176	€203	SOLAS option for single tank drop in

	PRICE £	PRICE €	DESCRIPTION
O*	£2271	€2612	Single oil return pump
O*	£1620	€1863	Single auto basket lift
O*	£176	€203	SOLAS option for single tank drop in

	PRICE £	PRICE €	DESCRIPTION
O*	£2271	€2612	Single oil return pump
O*	£1620	€1863	Single auto basket lift
O*	£3238	€3724	Twin auto basket lift
O*	£176	€203	SOLAS option for single tank drop in

MODEL	PRICE £	PRICE €	DESCRIPTION
A FRIFRI/USB	£28	€33	USB Stick

MODEL	PRICE £	PRICE €	DESCRIPTION
A FZ301093	£126	€145	Small baskets for 311
A FRIFRI/USB	£28	€33	USB Stick

MODEL	PRICE £	PRICE €	DESCRIPTION
A FZ411048	£167	€193	Large basket for 400mm wide single tank
A FRIFRI/USB	£28	€33	USB Stick



** 7mm Frozen Fries

*** No. of baskets shown in brackets are an available option. Please call for more details

O* Factory fitted option please request at point of ordering

* Please refer to pages F36 to F37 for electricity supply requirements

Fryer Designer

Touch

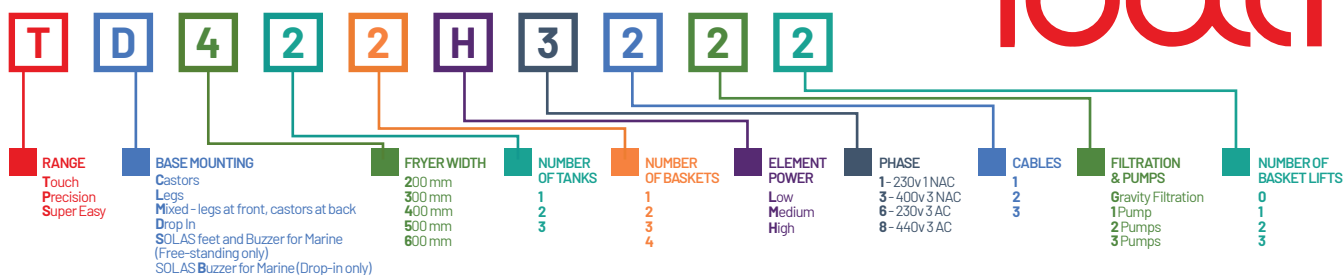

The models in the table are for base models supplied on legs, without pumped oil filtration or basket lifts.

Do you want an alternative configuration of baskets? **How many** supply cables would you like?
Do you require chargeable add on items such as castors and pumped oil filtration?

Please use our Fryer Designer to create your bespoke code. If you would like help to create code please **call us on 01522 875500**.

Touch Twin Tank Drop In Fryers



422 Twin tank electric fryer (400mm wide)

OIL CAPACITY	NO. OF TANKS	NO. OF BASKETS	DIMENSIONS (mm)			NET WT
			H	W	D	
2 x 7.5-9 L	2	2	809	397.5	630	68

522 Twin tank electric fryer (500mm wide)

OIL CAPACITY	NO. OF TANKS	NO. OF BASKETS	DIMENSIONS (mm)			NET WT
			H	W	D	
1 x 12.5-14.5 + 1 x 7.5-9 L	2	2 (3)**	809	495	630	87

622 Twin tank electric fryer (600mm wide)

OIL CAPACITY	NO. OF TANKS	NO. OF BASKETS	DIMENSIONS (mm)			NET WT
			H	W	D	
2 x 12.5-14.5 L	2	2 (3,4)**	809	592	630	94

MODEL	PRICE £	PRICE €	POWER	OUTPUT /HR (kg)**	PHASE	SUPPLY CABLES
*TD422L32G0	£8708	€10,015	2x7.5kW	2 x 18	3	2
*TD422L12G0	£8708	€10,015	2x7.5kW	2 x 18	1	2
*TD422M32G0	£8832	€10,157	2 x 9kW	2 x 20	3	2
*TD422M12G0	£8832	€10,157	2 x 9kW	2 x 20	1	2
*TD422H32G0	£8953	€10,296	2 x 11kW	2 x 22	3	2

MODEL	PRICE £	PRICE €	POWER	OUTPUT /HR (kg)**	PHASE	SUPPLY CABLES
*TD522L32G0	£9232	€10,617	11.4+7.5kW	28.5 + 18	3	2
*TD522M32G0	£9294	€10,689	11.4+9kW	28.5 + 20	3	2

MODEL	PRICE £	PRICE €	POWER	OUTPUT /HR (kg)**	PHASE	SUPPLY CABLES
*TD622L32G0	£9926	€11,415	2x11.4kW	2x26.5	3	2
*TD622H32G0	£10,074	€11,586	2 x 15kW	2x26.5	3	2

PRICE £	PRICE €	DESCRIPTION
0* £2271	€2612	Single oil return pump
0* £4537	€5218	Twin oil return pump
0* £1620	€1863	Single auto basket lift
0* £3238	€3724	Twin auto basket lift
0* £346	€398	SOLAS option for twin tank drop in

PRICE £	PRICE €	DESCRIPTION
0* £2271	€2612	Single oil return pump
0* £4537	€5218	Twin oil return pump
0* £1620	€1863	Single auto basket lift
0* £3238	€3724	Twin auto basket lift
0* £346	€398	SOLAS option for twin tank drop in

PRICE £	PRICE €	DESCRIPTION
0* £2271	€2612	Single oil return pump
0* £4537	€5218	Twin oil return pump
0* £1620	€1863	Single auto basket lift
0* £3238	€3724	Twin auto basket lift
0* £346	€398	SOLAS option for twin tank drop in

MODEL	PRICE £	PRICE €	DESCRIPTION
A FRIFRI/USB	£28	€33	USB Stick

MODEL	PRICE £	PRICE €	DESCRIPTION
A FZ301093	£126	€145	Small baskets for large tank
A FRIFRI/USB	£28	€33	USB Stick

MODEL	PRICE £	PRICE €	DESCRIPTION
A FZ301093	£126	€145	Small baskets for 622
A FRIFRI/USB	£28	€33	USB Stick

** 7mm Frozen Fries

*** No. of baskets shown in brackets are an available option. Please call for more details

* Please refer to pages F36 to F37 for electricity supply requirements

0* Factory fitted option please request at point of ordering



Touch

As standard



Electronic Temperature Control



Touchscreen Programmable Controls



Adaptive Cooking



Oil Management



Eco Mode



Gravity-fed Oil Filtration



Data Management



Horizontally Coiled Elements



Allergen Control

Optional



xFri[®] Pumped Oil Filtration Option



LiftFri[®] Automatic Basket Lift Option



SOLAS Specification Option

Touch Triple Tank Drop In Fryers



600mm wide triple tank fryer
EXCLUSIVE TO FRIFRI
 • Allergen Control
 • Flexibility

633 Triple tank electric fryer (600mm wide)

OIL CAPACITY	NO. OF TANKS	NO. OF BASKETS	DIMENSIONS (mm)			NET WT
			H	W	D	
3 x 7.5-9 L	3	3	809	592	630	94

MODEL	PRICE £	PRICE €	POWER	OUTPUT /HR (kg)**	PHASE	SUPPLY CABLES
*TD633L31G0	£12,808	€14,730	3 x 7.5kW	3 x 18	3	1
*TD633L33G0	£12,808	€14,730	3 x 7.5kW	3 x 18	3	3
*TD633L13G0	£12,808	€14,730	3 x 7.5kW	3 x 18	1	3
*TD633M31G0	£12,997	€14,947	3 x 9kW	3 x 20	3	1
*TD633M33G0	£12,997	€14,947	3 x 9kW	3 x 20	3	3
*TD633M13G0	£12,997	€14,947	3 x 9kW	3 x 20	1	3

PRICE £	PRICE €	DESCRIPTION	
0*	£2271	€ 2612	Single oil return pump
0*	£6585	€ 7573	Triple oil return pump
0*	£1620	€ 1863	Single auto basket lift
0*	£3238	€3724	Twin auto basket lift
0*	£5032	€5787	Triple auto basket lift
0*	£393	€452	SOLAS option for triple tank drop in

** 7mm Frozen Fries

*** No. of baskets shown in brackets are an available option. Please call for more details

0* Factory fitted option please request at point of ordering

* Please refer to pages F36 to F37 for electricity supply requirements



As standard



Electronic Temperature Control



Touchpad Control



Timer



Temperature View



Adaptive Cooking



Gravity-fed Oil Filtration



Horizontally Coiled Elements



Allergen Control

Optional



xFri® Pumped Oil Filtration Option



LiftFri® Automatic Basket Lift Option



SOLAS Specification Option

Precision

For the chef who wants superb temperature control for consistently excellent results, Precision is the fryer of choice.

Ideally suited for use in



Chains



Independents



Gastronomy



Education



Electronic Temperature Control

Electronic temperature control and powerful elements always maintain oil to within +/-1 °C of your required setting, reducing oil absorption and ensuring your food always has that all-important crunch. The LED display shows the current oil temperature throughout the cook cycle.



Timer

Set the timer and see the display count down, with the buzzer sounding at the end of the cook cycle.

If the fryer has LiftFri the basket will automatically lower when the oil has reached the correct temperature. At the end of the cook cycle, the buzzer will sound and the basket will rise from the oil. The LED display will then reset to show the set time for the next batch. Perfect for when you want to cook the same product time after time, to the same exacting standards.



Temperature View

Temperature view shows you the current oil temperature, enabling you to make an informed decision as to when to start cooking.



Adaptive Cooking

Are there more fries than last time? Automatically adjust cooking times to suit your batch size ensuring you never serve undercooked food.



Gravity-fed Oil Filtration

Our integral filtration system extends oil life by up to 75% saving you money on oil purchase and disposal costs. The dual filter system removes debris and carbonised particles.



Precision 211 drop-in

Optional



xFri® Pumped Oil Filtration Option

xFri® filters oil at the push of a button and returns the cleaned oil to the tank. You can filter the oil safely while it's still hot, mid-service if necessary, and resume frying in under five minutes.



Allergen Control

For optimum oil segregation, fryers with two or three tanks can be supplied with separate oil pumps.



LiftFri® Automatic Basket Lift Option

Great for kitchens where you don't have time for constant supervision, LiftFri® automatic basket lifting system lifts food at the end of the cycle to prevent overcooking.











Precision 633





Precision

As standard

- 
Electronic Temperature Control
- 
Touchpad Control
- 
Timer
- 
Temperature View
- 
Adaptive Cooking
- 
Gravity-fed Oil Filtration
- 
Horizontally Coiled Elements
- 
Allergen Control

Optional

- 
xFri[®] Pumped Oil Filtration Option
- 
LiftFri[®] Automatic Basket Lift Option
- 
SOLAS Specification Option

Precision Single Tank Free Standing Fryers



† 411 single basket version available

211 Single tank electric fryer (200mm wide)

OIL CAPACITY	NO. OF TANKS	NO. OF BASKETS	DIMENSIONS (mm)			NET WT
			H	W	D	
7.5-9 L	1	1	994	197.5	650	47

311 Single tank electric fryer (300mm wide)

OIL CAPACITY	NO. OF TANKS	NO. OF BASKETS	DIMENSIONS (mm)			NET WT
			H	W	D	
12.5-14.5 L	1	1 (2) ^{***}	994	297.5	650	56

412 Single tank electric fryer (400mm wide)

OIL CAPACITY	NO. OF TANKS	NO. OF BASKETS	DIMENSIONS (mm)			NET WT
			H	W	D	
17-20.5 L	1	2 (1) ^{***}	994	397.5	650	69

MODEL	PRICE £	PRICE €	POWER	OUTPUT /HR (kg)**	PHASE	SUPPLY CABLES
*PL211L31G0	£3995	€4595	7.5kW	18	3	1
*PL211L11G0	£3995	€4595	7.5kW	18	1	1
*PL211M31G0	£4063	€4673	9kW	20	3	1
*PL211M11G0	£4063	€4673	9kW	20	1	1
*PL211H31G0	£4128	€4748	11kW	22	3	1

MODEL	PRICE £	PRICE €	POWER	OUTPUT /HR (kg)**	PHASE	SUPPLY CABLES
*PL311L31G0	£4774	€5491	11.4kW	28.5	3	1
*PL311H31G0	£4853	€5581	15kW	32	3	1

MODEL	PRICE £	PRICE €	POWER	OUTPUT /HR (kg)**	PHASE	SUPPLY CABLES
*PL412L31G0	£5529	€6359	15kW	36	3	1
*PL412M31G0	£5662	€6512	18kW	40	3	1
*PL412H31G0	£5795	€6665	22kW	44	3	1



	PRICE £	PRICE €	DESCRIPTION
0*	£2271	€2612	Single oil return pump
0*	£1620	€1863	Single auto basket lift
0*	£274	€316	SOLAS option for single tank free-standing

	PRICE £	PRICE €	DESCRIPTION
0*	£2271	€2612	Single oil return pump
0*	£1620	€1863	Single auto basket lift
0*	£173	€199	Two rear castors (fixed)
0*	£346	€398	Four castors (fixed castors at rear)
0*	£274	€316	SOLAS option for single tank free-standing

	PRICE £	PRICE €	DESCRIPTION
0*	£2271	€2612	Single oil return pump
0*	£1620	€1863	Single auto basket lift
0*	£173	€199	Two rear castors (fixed)
0*	£346	€398	Four castors (fixed castors at rear)
0*	£274	€316	SOLAS option for single tank free-standing

MODEL	PRICE £	PRICE €	DESCRIPTION
A FZ301093	£126	€145	Small baskets for 300mm wide single tank

MODEL	PRICE £	PRICE €	DESCRIPTION
A FZ411048	£167	€193	Large basket for 400mm wide single tank

** 7mm Frozen Fries

*** No. of baskets shown in brackets are an available option. Please call for more details

0* Factory fitted option please request at point of ordering

† 412 pricing applies

* Please refer to pages F36 to F37 for electricity supply requirements

Fryer Designer

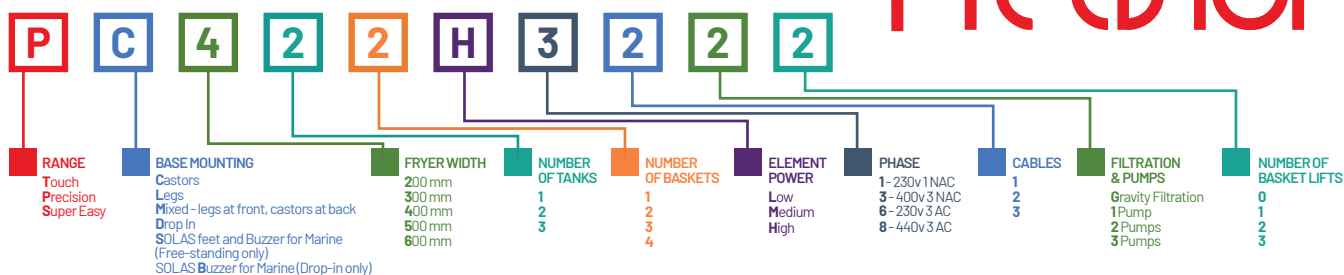

The models in the table are for base models supplied on legs, without pumped oil filtration or basket lifts.

Do you want an alternative configuration of baskets? **How many** supply cables would you like?
Do you require chargeable add on items such as castors and pumped oil filtration?

Please use our Fryer Designer to create your bespoke code. If you would like help to create code please **call us on 01522 875500**.

Precision Twin Tank Free Standing Fryers

Precision Triple Tank Free Standing Fryers



600mm wide triple tank fryer
EXCLUSIVE TO FRIFRI
• Allergen Control
• Flexibility

422 Twin tank electric fryer (400mm wide)

OIL CAPACITY	NO. OF TANKS	NO. OF BASKETS	DIMENSIONS (mm)			NET WT
			H	W	D	
2 x 7.5-9 L	2	2	994	397.5	650	79

622 Twin tank electric fryer (600mm wide)

OIL CAPACITY	NO. OF TANKS	NO. OF BASKETS	DIMENSIONS (mm)			NET WT
			H	W	D	
2x12.5-14.5L	2	2 (3,4)***	994	592	650	99

633 Triple tank electric fryer (600mm wide)

OIL CAPACITY	NO. OF TANKS	NO. OF BASKETS	DIMENSIONS (mm)			NET WT
			H	W	D	
3x7.5-9 L	3	3	994	592	650	99

MODEL	PRICE £	PRICE €	POWER	OUTPUT /HR (kg)**	PHASE	SUPPLY CABLES
*PL422L32G0	£6801	€7822	2x7.5kW	2 x 18	3	2
*PL422L12G0	£6801	€7822	2x7.5kW	2 x 18	1	2
*PL422M32G0	£6930	€7970	2 x 9kW	2 x 20	3	2
*PL422M12G0	£6930	€7970	2 x 9kW	2 x 20	1	2
*PL422H32G0	£7068	€8129	2 x 11kW	2 x 22	3	2

MODEL	PRICE £	PRICE €	POWER	OUTPUT /HR (kg)**	PHASE	SUPPLY CABLES
*PL622L32G0	£8672	€9973	2x11.4kW	2x26.5	3	2
*PL622H32G0	£8834	€10,160	2 x 15kW	2x26.5	3	2

MODEL	PRICE £	PRICE €	POWER	OUTPUT /HR (kg)**	PHASE	SUPPLY CABLES
*PL633L31G0	£10,591	€12,180	3x7.5kW	3 x 18	3	1
*PL633L33G0	£10,591	€12,180	3x7.5kW	3 x 18	3	3
*PL633L13G0	£10,591	€12,180	3x7.5kW	3 x 18	1	3
*PL633M31G0	£10,673	€12,274	3 x 9kW	3 x 20	3	1
*PL633M33G0	£10,673	€12,274	3 x 9kW	3 x 20	3	3
*PL633M13G0	£10,673	€12,274	3 x 9kW	3 x 20	1	3

	PRICE £	PRICE €	DESCRIPTION
0*	£2271	€2612	Single oil return pump
0*	£4537	€5218	Twin oil return pump
0*	£1620	€1863	Single auto basket lift
0*	£3238	€3724	Twin auto basket lift
0*	£173	€199	Two rear castors (fixed)
0*	£346	€398	Four castors (fixed castors at rear)
0*	£445	€512	SOLAS option for twin tank free-standing

	PRICE £	PRICE €	DESCRIPTION
0*	£2271	€2612	Single oil return pump
0*	£4537	€5218	Twin oil return pump
0*	£1620	€1863	Single auto basket lift
0*	£3238	€3724	Twin auto basket lift
0*	£173	€199	Two rear castors (fixed)
0*	£346	€398	Four castors (fixed castors at rear)
0*	£445	€512	SOLAS option for twin tank free-standing

	PRICE £	PRICE €	DESCRIPTION
0*	£2271	€2612	Single oil return pump
0*	£6585	€7573	Triple oil return pump
0*	£1620	€1863	Single auto basket lift
0*	£3238	€3724	Twin auto basket lift
0*	£5032	€5787	Triple auto basket lift
0*	£173	€199	Two rear castors (fixed)
0*	£346	€398	Four castors (fixed castors at rear)
0*	£615	€708	SOLAS option for triple tank free-standing

MODEL	PRICE £	PRICE €	DESCRIPTION
A FZ301093	£126	€145	Small baskets for 600mm wide twin tank

* Please refer to pages F36 to F37 for electricity supply requirements

** 7mm Frozen Fries
*** No. of baskets shown in brackets are an available option. Please call for more details
0* Factory fitted option please request at point of ordering

Precision

As standard



Electronic Temperature Control



Touchpad Control



Timer



Temperature View



Adaptive Cooking



Gravity-fed Oil Filtration



Horizontally Coiled Elements



Allergen Control

Optional



xFri® Pumped Oil Filtration Option



LiftFri® Automatic Basket Lift Option



SOLAS Specification Option

Precision Single Tank Drop In Fryers



211 Single tank electric fryer (200mm wide)

OIL CAPACITY	NO. OF TANKS	NO. OF BASKETS	DIMENSIONS (mm)			NET WT
			H	W	D	
7.5-9 L	1	1	809	197.5	630	40

311 Single tank electric fryer (300mm wide)

OIL CAPACITY	NO. OF TANKS	NO. OF BASKETS	DIMENSIONS (mm)			NET WT
			H	W	D	
12.5-14.5 L	1	1 (2)***	809	297.5	630	47

412 Single tank electric fryer (400mm wide)

OIL CAPACITY	NO. OF TANKS	NO. OF BASKETS	DIMENSIONS (mm)			NET WT
			H	W	D	
17-20.5 L	1	2 (1)***	809	397.5	630	62

MODEL	PRICE £	PRICE €	POWER	OUTPUT /HR (kg)**	PHASE	SUPPLY CABLES
*PD211L31G0	£3901	€4487	7.5kW	18	3	1
*PD211L11G0	£3901	€4487	7.5kW	18	1	1
*PD211M31G0	£3970	€4566	9kW	20	3	1
*PD211M11G0	£3970	€4566	9kW	20	1	1
*PD211H31G0	£4033	€4638	11kW	22	3	1

MODEL	PRICE £	PRICE €	POWER	OUTPUT /HR (kg)**	PHASE	SUPPLY CABLES
*PD311L31G0	£4654	€5353	11.4kW	28.5	3	1
*PD311H31G0	£4736	€5447	15kW	32	3	1

MODEL	PRICE £	PRICE €	POWER	OUTPUT /HR (kg)**	PHASE	SUPPLY CABLES
*PD412L31G0	£5388	€6197	15kW	36	3	1
*PD412M31G0	£5519	€6347	18kW	40	3	1
*PD412H31G0	£5650	€6498	22kW	44	3	1

	PRICE £	PRICE €	DESCRIPTION
O*	£2271	€2612	Single oil return pump
O*	£1620	€1863	Single auto basket lift
O*	£176	€203	SOLAS option for single tank drop-in

	PRICE £	PRICE €	DESCRIPTION
O*	£2271	€2612	Single oil return pump
O*	£1620	€1863	Single auto basket lift
O*	£176	€203	SOLAS option for single tank drop-in

	PRICE £	PRICE €	DESCRIPTION
O*	£2271	€2612	Single oil return pump
O*	£1620	€1863	Single auto basket lift
O*	£176	€203	SOLAS option for single tank drop-in

	MODEL	PRICE £	PRICE €	DESCRIPTION
A	FZ301093	£126	€145	Small baskets for 311

	MODEL	PRICE £	PRICE €	DESCRIPTION
A	FZ411048	£167	€193	Large basket for 411



** 7mm Frozen Fries

*** No. of baskets shown in brackets are an available option. Please call for more details

O* Factory fitted option please request at point of ordering

* Please refer to pages F36 to F37 for electricity supply requirements

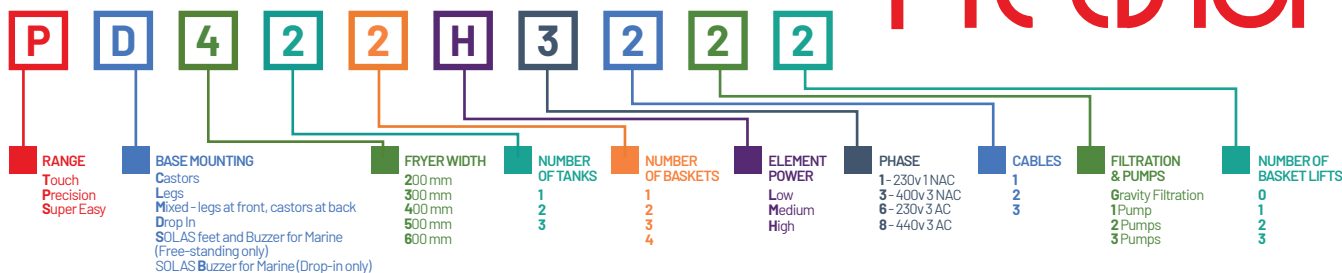

The models in the table are for base models supplied on legs, without pumped oil filtration or basket lifts.

Do you want an alternative configuration of baskets? **How many** supply cables would you like?
Do you require chargeable add on items such as castors and pumped oil filtration?

Please use our Fryer Designer to create your bespoke code. If you would like help to create code please **call us on 01522 875500**.

Precision Twin Tank Drop In Fryers



422 Twin tank electric fryer (400mm wide)

OIL CAPACITY	NO. OF TANKS	NO. OF BASKETS	DIMENSIONS (mm)			NET WT
			H	W	D	
2 x 7.5-9 L	2	2	809	397.5	630	68

522 Twin tank electric fryer (500mm wide)

OIL CAPACITY	NO. OF TANKS	NO. OF BASKETS	DIMENSIONS (mm)			NET WT
			H	W	D	
1 x 12.5-14.5 + 1 x 7.5-9 L	2	2 (3)**	809	495	630	87

622 Twin tank electric fryer (600mm wide)

OIL CAPACITY	NO. OF TANKS	NO. OF BASKETS	DIMENSIONS (mm)			NET WT
			H	W	D	
2x12.5-14.5L	2	2 (3,4)**	809	592	630	94

MODEL	PRICE £	PRICE €	POWER	OUTPUT /HR (kg)**	PHASE	SUPPLY CABLES
*PD422L32G0	£6634	€7630	2 x 7.5kW	2 x 18	3	2
*PD422L12G0	£6634	€7630	2 x 7.5kW	2 x 18	1	2
*PD422M32G0	£6766	€7781	2 x 9kW	2 x 20	3	2
*PD422M12G0	£6766	€7781	2 x 9kW	2 x 20	1	2
*PD422H32G0	£6899	€7934	2 x 11kW	2 x 22	3	2

MODEL	PRICE £	PRICE €	POWER	OUTPUT /HR (kg)**	PHASE	SUPPLY CABLES
*PD522L32G0	£7369	€8475	11.4+7.5kW	28.5 + 18	3	2
*PD522M32G0	£7428	€8543	11.4+9kW	28.5 + 20	3	2

MODEL	PRICE £	PRICE €	POWER	OUTPUT /HR (kg)**	PHASE	SUPPLY CABLES
*PD622L32G0	£7810	€8982	2x11.4kW	2x26.5	3	2
*PD622H32G0	£7962	€9157	2 x 15kW	2x26.5	3	2

	PRICE £	PRICE €	DESCRIPTION
0*	£2271	€2612	Single oil return pump
0*	£4537	€5218	Twin oil return pump
0*	£1620	€1863	Single auto basket lift
0*	£3238	€3724	Twin auto basket lift
0*	£346	€398	SOLAS option for twin tank drop-in

	PRICE £	PRICE €	DESCRIPTION
0*	£2271	€2612	Single oil return pump
0*	£4537	€5218	Twin oil return pump
0*	£1620	€1863	Single auto basket lift
0*	£3238	€3724	Twin auto basket lift
0*	£346	€398	SOLAS option for twin tank drop-in

	PRICE £	PRICE €	DESCRIPTION
0*	£2271	€2612	Single oil return pump
0*	£4537	€5218	Twin oil return pump
0*	£1620	€1863	Single auto basket lift
0*	£3238	€3724	Twin auto basket lift
0*	£346	€398	SOLAS option for twin tank drop-in

MODEL	PRICE £	PRICE €	DESCRIPTION
A FZ301093	£126	€145	Small baskets for large tank

MODEL	PRICE £	PRICE €	DESCRIPTION
A FZ301093	£126	€145	Small baskets for 622

** 7mm Frozen Fries

*** No. of baskets shown in brackets are an available option. Please call for more details

* Please refer to pages F36 to F37 for electricity supply requirements

0* Factory fitted option please request at point of ordering



Precision

As standard



Electronic Temperature Control



Touchpad Control



Timer



Temperature View



Adaptive Cooking



Gravity-fed Oil Filtration



Horizontally Coiled Elements



Allergen Control

Optional



xFri[®] Pumped Oil Filtration Option



LiftFri[®] Automatic Basket Lift Option



SOLAS Specification Option

Precision Triple Tank Drop In Fryers



600mm wide triple tank fryer
EXCLUSIVE TO FRIFRI
 • Allergen Control
 • Flexibility

633 Triple tank electric fryer (600mm wide)

OIL CAPACITY	NO. OF TANKS	NO. OF BASKETS	DIMENSIONS (mm)				NET WT
			H	W	D		
3 x 7.5-9 L	3	3	809	592	630	94	

MODEL	PRICE £	PRICE €	POWER	OUTPUT /HR (kg)**	PHASE	SUPPLY CABLES
*PD633L31G0	£9366	€10,771	3x 7.5kW	3 x 18	3	1
*PD633L33G0	£9366	€10,771	3x 7.5kW	3 x 18	3	3
*PD633L13G0	£9366	€10,771	3x 7.5kW	3 x 18	1	3
*PD633M31G0	£9562	€10,997	3 x 9kW	3 x 20	3	1
*PD633M33G0	£9562	€10,997	3 x 9kW	3 x 20	3	3
*PD633M13G0	£9562	€10,997	3 x 9kW	3 x 20	1	3

	PRICE £	PRICE €	DESCRIPTION
0*	£2271	€2612	Single oil return pump
0*	£6585	€7573	Triple oil return pump
0*	£1620	€1863	Single auto basket lift
0*	£3238	€3724	Twin auto basket lift
0*	£5032	€5787	Triple auto basket lift
0*	£393	€452	SOLAS option for triple tank drop-in

** 7mm Frozen Fries

*** No. of baskets shown in brackets are an available option. Please call for more details

0* Factory fitted option please request at point of ordering

* Please refer to pages F36 to F37 for electricity supply requirements

Super*easy

Outstanding value with no compromise in quality or performance.

When budget is a primary consideration, FriFri's unrivalled credentials, know-how and quality are still well within your reach.

Super Easy offers all the benefits you would expect from a FriFri fryer including high output from a small floor area and reliable, efficient performance that delivers consistently excellent fried food.

Quality construction, for example the 304 grade stainless steel pressed pan, and details such as the hinged frying elements will reassure you that Super Easy is anything but a compromise.

As standard



Thermostatic Temperature Control



Rotary Control Front



Allergen Control

Optional



Gravity-fed Oil Filtration



xFri[®] Pumped Oil Filtration Option

Ideally suited for use in



Restaurants



Hotels



Institutional Establishment



Super Easy 211



Super Easy 633



Super Easy 422 drop-in

Optional

If you're looking for that little bit extra in specification, options such as integral or pumped filtration and higher power are also available.



xFri[®] Pumped Oil Filtration Option

xFri[®] filters oil at the push of a button and returns the cleaned oil to the tank. You can filter the oil safely while its still hot, mid-service if necessary, and resume frying in under five minutes.



Allergen Control

For optimum oil segregation, fryers with two or three tanks can be supplied with separate oil pumps.



As standard



Thermostatic Temperature Control



Rotary Control Front



Allergen Control

Optional



Gravity-fed Oil Filtration



xFri[®] Pumped Oil Filtration Option

Super Easy Single Tank Free Standing Fryers



† 411 single basket version available

211 Single tank electric fryer (200mm wide)

OIL CAPACITY	NO. OF TANKS	NO. OF BASKETS	DIMENSIONS (mm)			NET WT
			H	W	D	
7.5-9 L	1	1	986	197.5	650	39

311 Single tank electric fryer (300mm wide)

OIL CAPACITY	NO. OF TANKS	NO. OF BASKETS	DIMENSIONS (mm)			NET WT
			H	W	D	
12.5-14.5 L	1	1 (2)***	986	297.5	650	48

412 Single tank electric fryer (400mm wide)

OIL CAPACITY	NO. OF TANKS	NO. OF BASKETS	DIMENSIONS (mm)			NET WT
			H	W	D	
17-20.5 L	1	2 (1)***	986	397.5	650	52

With Gravity Filtration

MODEL	PRICE £	PRICE €	POWER	OUTPUT /HR (kg)**	PHASE	SUPPLY CABLES
*SL211L31G0	£2732	€3142	7.5kW	17	3	1
*SL211L11G0	£2732	€3142	7.5kW	17	1	1
*SL211H31G0	£2810	€3232	11kW	20	3	1

With Gravity Filtration

MODEL	PRICE £	PRICE €	POWER	OUTPUT /HR (kg)**	PHASE	SUPPLY CABLES
*SL311L31G0	£3392	€3901	11.4kW	26.5	3	1
*SL311H31G0	£3446	€3963	15kW	30	3	1

With Gravity Filtration

MODEL	PRICE £	PRICE €	POWER	OUTPUT /HR (kg)**	PHASE	SUPPLY CABLES
*SL412L31G0	£3702	€4258	15kW	34	3	1
*SL412H31G0	£3931	€4521	22kW	40	3	1



PRICE £	PRICE €	DESCRIPTION
0* £2271	€2612	Single oil return pump

PRICE £	PRICE €	DESCRIPTION
0* £2271	€2612	Single oil return pump
0* £173	€199	Two rear castors (fixed)
0* £346	€398	Four castors (fixed castors at rear)

PRICE £	PRICE €	DESCRIPTION
0* £2271	€2612	Single oil return pump
0* £173	€199	Two rear castors (fixed)
0* £346	€398	Four castors (fixed castors at rear)

Without Gravity Filtration

MODEL	PRICE £	PRICE €	POWER	OUTPUT /HR (kg)**	PHASE	SUPPLY CABLES
*SL211L31N0	£2528	€2908	7.5kW	17	3	1
*SL211L11N0	£2528	€2908	7.5kW	17	1	1
*SL211H31N0	£2604	€2995	11kW	20	3	1

Without Gravity Filtration

MODEL	PRICE £	PRICE €	POWER	OUTPUT /HR (kg)**	PHASE	SUPPLY CABLES
*SL311L31N0	£3153	€3626	11.4kW	26.5	3	1
*SL311H31N0	£3210	€3692	15kW	30	3	1

Without Gravity Filtration

MODEL	PRICE £	PRICE €	POWER	OUTPUT /HR (kg)**	PHASE	SUPPLY CABLES
*SL412L31N0	£3463	€3983	15kW	34	3	1
*SL412H31N0	£3693	€4247	22kW	40	3	1

MODEL	PRICE £	PRICE €	DESCRIPTION
A FZ301093	£126	€145	Small baskets for 300mm wide single tank

MODEL	PRICE £	PRICE €	DESCRIPTION
A FZ411048	£167	€193	Large basket for 400mm wide single tank

** 7mm Frozen Fries

*** No. of baskets shown in brackets are an available option. Please call for more details

0* Factory fitted option please request at point of ordering

† 412 pricing applies

* Please refer to pages F36 to F37 for electricity supply requirements

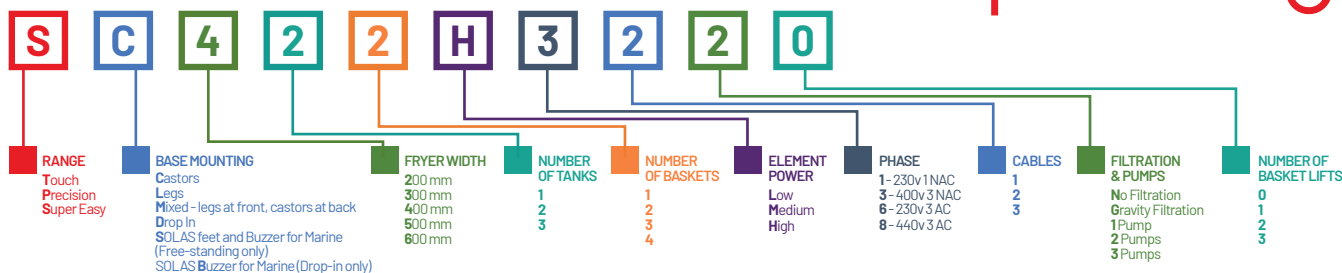

The models in the table are for base models supplied on legs, without pumped oil filtration or basket lifts.

Do you want an alternative configuration of baskets? **How many** supply cables would you like? **Do you require** chargeable add on items such as castors and pumped oil filtration?

Please use our Fryer Designer to create your bespoke code. If you would like help to create code please **call us on 01522 875500**.

Super Easy Twin Tank Free Standing Fryers

Super Easy Triple Tank Free Standing Fryers



600mm wide triple tank fryer
EXCLUSIVE TO FRIFRI
• Allergen Control
• Flexibility

422 Twin tank electric fryer (400mm wide)

OIL CAPACITY	NO. OF TANKS	NO. OF BASKETS	DIMENSIONS (mm)			NET WT
			H	W	D	
2 x 7.5-9 L	2	2	986	397.5	650	56

622 Twin tank electric fryer (600mm wide)

OIL CAPACITY	NO. OF TANKS	NO. OF BASKETS	DIMENSIONS (mm)			NET WT
			H	W	D	
2x12.5-14.5L	2	2 (3,4)***	986	592	650	99

633 Triple tank electric fryer (600mm wide)

OIL CAPACITY	NO. OF TANKS	NO. OF BASKETS	DIMENSIONS (mm)			NET WT
			H	W	D	
3 x 7.5-9 L	3	3	986	592	650	99

With Gravity Filtration

MODEL	PRICE £	PRICE €	POWER	OUTPUT /HR (kg)**	PHASE	SUPPLY CABLES
*SL422L32G0	£4630	€5325	2x7.5kW	2x17	3	2
*SL422L12G0	£4630	€5325	2x7.5kW	2x17	1	2
*SL422H32G0	£4798	€5518	2 x 11kW	2x20	3	2

With Gravity Filtration

MODEL	PRICE £	PRICE €	POWER	OUTPUT /HR (kg)**	PHASE	SUPPLY CABLES
*SL622L32G0	£5220	€6003	2 x 11.4kW	2x26.5	3	2
*SL622H32G0	£5319	€6117	2 x 15kW	2x26.5	3	2

With Gravity Filtration

MODEL	PRICE £	PRICE €	POWER	OUTPUT /HR (kg)**	PHASE	SUPPLY CABLES
*SL633L31G0	£7125	€8194	3 x 7.5kW	3 x 18	3	1
*SL633L33G0	£7125	€8194	3 x 7.5kW	3 x 18	3	3
*SL633L13G0	£7206	€8287	3 x 7.5kW	3 x 18	1	3
*SL633H31G0	£7206	€8287	3 x 11kW	3 x 20	3	1
*SL633H33G0	£7206	€8287	3 x 11kW	3 x 20	3	3

	PRICE £	PRICE €	DESCRIPTION
0*	£2271	€2612	Single oil return pump
0*	£4537	€5218	Twin oil return pump
0*	£173	€199	Two rear castors (fixed)
0*	£346	€398	Four castors (fixed castors at rear)

	PRICE £	PRICE €	DESCRIPTION
0*	£2271	€2612	Single oil return pump
0*	£4537	€5218	Twin oil return pump
0*	£173	€199	Two rear castors (fixed)
0*	£346	€398	Four castors (fixed castors at rear)

	PRICE £	PRICE €	DESCRIPTION
0*	£2271	€2612	Single oil return pump
0*	£4537	€5218	Triple oil return pump
0*	£173	€199	Two rear castors (fixed)
0*	£346	€398	Four castors (fixed castors at rear)

MODEL	PRICE £	PRICE €	DESCRIPTION
A FZ301093	£126	€145	Small baskets for 600mm wide twin tank

Without Gravity Filtration

MODEL	PRICE £	PRICE €	POWER	OUTPUT /HR (kg)**	PHASE	SUPPLY CABLES
*SL422L32N0	£4225	€4859	2x7.5kW	2 x 17	3	2
*SL422L12N0	£4225	€4859	2x7.5kW	2 x 17	1	2
*SL422H32N0	£4392	€5051	2 x 11kW	2 x 20	3	2

Without Gravity Filtration

MODEL	PRICE £	PRICE €	POWER	OUTPUT /HR (kg)**	PHASE	SUPPLY CABLES
*SL622L32N0	£4827	€5552	2x11.4kW	2x26.5	3	2
*SL622H32N0	£4934	€5675	2 x 15kW	2x26.5	3	2

Without Gravity Filtration

MODEL	PRICE £	PRICE €	POWER	OUTPUT /HR (kg)**	PHASE	SUPPLY CABLES
SL633L31N0	£6688	€7692	3 x 7.5kW	3 x 18	3	1
SL633L33N0	£6688	€7692	3 x 7.5kW	3 x 18	3	3
SL633L13N0	£6879	€7911	3 x 7.5kW	3 x 18	1	3
SL633H31N0	£6879	€7911	3 x 11kW	3 x 18	3	1
SL633H33N0	£6879	€7911	3 x 11kW	3 x 18	3	3

** 7mm Frozen Fries

*** No. of baskets shown in brackets are an available option. Please call for more details

0* Factory fitted option please request at point of ordering

* Please refer to pages F36 to F37 for electricity supply requirements



As standard



Thermostatic Temperature Control



Rotary Control Front



Allergen Control

Optional



Gravity-fed Oil Filtration



xFri[®] Pumped Oil Filtration Option

Super Easy Single Tank Drop In Fryers



211 Single tank electric fryer (200mm wide)

OIL CAPACITY	NO. OF TANKS	NO. OF BASKETS	DIMENSIONS (mm)			NET WT
			H	W	D	
7.5-9 L	1	1	864	197.5	630	21

311 Single tank electric fryer (300mm wide)

OIL CAPACITY	NO. OF TANKS	NO. OF BASKETS	DIMENSIONS (mm)			NET WT
			H	W	D	
12.5-14.5 L	1	1 (2)***	864	297.5	630	26

412 Single tank electric fryer (400mm wide)

OIL CAPACITY	NO. OF TANKS	NO. OF BASKETS	DIMENSIONS (mm)			NET WT
			H	W	D	
17-20.5 L	1	2 (1)***	864	397.5	630	30

With Gravity Filtration

MODEL	PRICE £	PRICE €	POWER	OUTPUT /HR (kg)**	PHASE	SUPPLY CABLES
*SD211L31G0	£2371	€2727	7.5kW	17	3	1
*SD211L11G0	£2371	€2727	7.5kW	17	1	1
*SD211H31G0	£2546	€2928	11kW	20	3	1

With Gravity Filtration

MODEL	PRICE £	PRICE €	POWER	OUTPUT /HR (kg)**	PHASE	SUPPLY CABLES
*SD311L31G0	£3057	€3516	11.4kW	26.5	3	1
*SD311H31G0	£3104	€3570	15kW	30	3	1

With Gravity Filtration

MODEL	PRICE £	PRICE €	POWER	OUTPUT /HR (kg)**	PHASE	SUPPLY CABLES
*SD412L31G0	£3238	€3724	15kW	34	3	1
*SD412H31G0	£3439	€3955	22kW	40	3	1

PRICE £	PRICE €	DESCRIPTION	
0*	£2271	€2612	Single oil return pump

PRICE £	PRICE €	DESCRIPTION	
0*	£2271	€2612	Single oil return pump

PRICE £	PRICE €	DESCRIPTION	
0*	£2271	€2612	Single oil return pump

MODEL	PRICE £	PRICE €	DESCRIPTION
A FZ301093	£126	€145	Small baskets for 311

MODEL	PRICE £	PRICE €	DESCRIPTION
A FZ411048	£167	€193	Large basket for 411

Without Gravity Filtration

MODEL	PRICE £	PRICE €	POWER	OUTPUT /HR (kg)**	PHASE	SUPPLY CABLES
*SD211L31N0	£2166	€2491	7.5kW	17	3	1
*SD211L11N0	£2166	€2491	7.5kW	17	1	1
*SD211H31N0	£2342	€2694	11kW	20	3	1

Without Gravity Filtration

MODEL	PRICE £	PRICE €	POWER	OUTPUT /HR (kg)**	PHASE	SUPPLY CABLES
*SD311L31N0	£2819	€3242	11.4kW	26.5	3	1
*SD311H31N0	£2866	€3296	15kW	30	3	1

Without Gravity Filtration

MODEL	PRICE £	PRICE €	POWER	OUTPUT /HR (kg)**	PHASE	SUPPLY CABLES
*SD412L31N0	£3001	€3452	15kW	34	3	1
*SD412H31N0	£3201	€3682	22kW	40	3	1

** 7mm Frozen Fries

*** No. of baskets shown in brackets are an available option. Please call for more details

0* Factory fitted option please request at point of ordering

* Please refer to pages F36 to F37 for electricity supply requirements

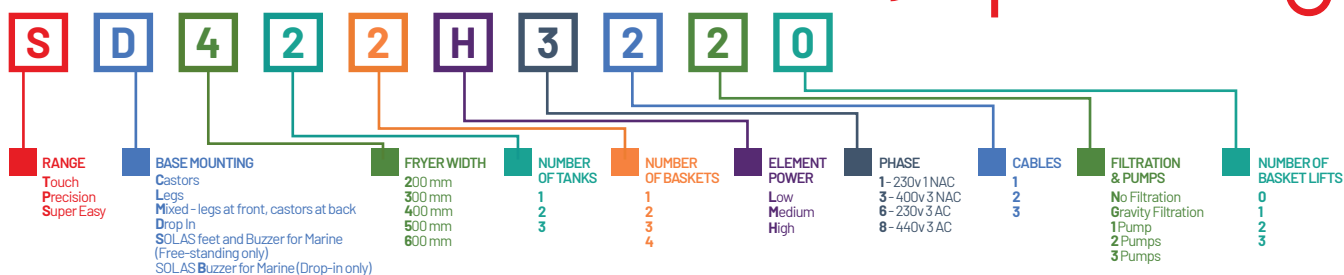

The models in the table are for base models supplied on legs, without pumped oil filtration or basket lifts.

Do you want an alternative configuration of baskets? **How many** supply cables would you like?
Do you require chargeable add on items such as castors and pumped oil filtration?

Please use our Fryer Designer to create your bespoke code. If you would like help to create code please **call us on 01522 875500**.

Super Easy Twin Tank Drop In Fryers



422 Twin tank electric fryer (400mm wide)

OIL CAPACITY	NO. OF TANKS	NO. OF BASKETS	DIMENSIONS (mm)			NET WT
			H	W	D	
2 x 7.5-9 L	2	2	864	397.5	630	35

622 Twin tank electric fryer (600mm wide)

OIL CAPACITY	NO. OF TANKS	NO. OF BASKETS	DIMENSIONS (mm)			NET WT
			H	W	D	
2 x 12.5-14.5L	2	2 (3,4)***	864	592	630	76

With Gravity Filtration

MODEL	PRICE £	PRICE €	POWER	OUTPUT /HR (kg)**	PHASE	SUPPLY CABLES
*SD422L32G0	£4162	€4787	2x7.5kW	2x17	3	1
*SD422L12G0	£4162	€4787	2x7.5kW	2x17	1	2
*SD422H32G0	£4400	€5060	2 x 11kW	2x20	3	2

With Gravity Filtration

MODEL	PRICE £	PRICE €	POWER	OUTPUT /HR (kg)**	PHASE	SUPPLY CABLES
*SD622L32G0	£4647	€5345	2x11.4kW	2 x 26.5	3	2
*SD622H32G0	£4788	€5507	2 x 15kW	2 x 26.5	3	2

	PRICE £	PRICE €	DESCRIPTION
0*	£2271	€2612	Single oil return pump
0*	£4537	€5218	Twin oil return pump

	PRICE £	PRICE €	DESCRIPTION
0*	£2271	€2612	Single oil return pump
0*	£4537	€5218	Twin oil return pump

MODEL	PRICE £	PRICE €	DESCRIPTION
A FZ301093	£126	€ 145	Small baskets for 622

Without Gravity Filtration

MODEL	PRICE £	PRICE €	POWER	OUTPUT /HR (kg)**	PHASE	SUPPLY CABLES
*SD422L32N0	£3755	€4319	2x7.5kW	2x17	3	1
*SD422L12N0	£3755	€4319	2x7.5kW	2x17	1	2
*SD422H32N0	£3994	€4594	2 x 11kW	2x20	3	2

Without Gravity Filtration

MODEL	PRICE £	PRICE €	POWER	OUTPUT /HR (kg)**	PHASE	SUPPLY CABLES
*SD622L32N0	£4297	€4942	2x11.4kW	2 x 26.5	3	2
*SD622H32N0	£4440	€5106	2 x 15kW	2 x 26.5	3	2

** 7mm Frozen Fries

*** No. of baskets shown in brackets are an available option. Please call for more details

* Please refer to pages F36 to F37 for electricity supply requirements

0* Factory fitted option please request at point of ordering

As standard



Thermostatic Temperature Control



Rotary Control Front



Allergen Control

Optional



Gravity-fed Oil Filtration



xFri[®] Pumped Oil Filtration Option

Super Easy Triple Tank Drop In Fryers



600mm wide triple tank fryer
EXCLUSIVE TO FRIFRI
 • Allergen Control
 • Flexibility

633 Triple tank electric fryer (600mm wide)

OIL CAPACITY	NO. OF TANKS	NO. OF BASKETS	DIMENSIONS (mm)			NET WT
			H	W	D	
3 x 7.5-9 L	3	3	864	592	630	76

With Gravity Filtration

MODEL	PRICE £	PRICE €	POWER	OUTPUT /HR (kg)**	PHASE	SUPPLY CABLES
*SD633L31G0	£5954	€6848	3 x 7.5kW	3 x 18	3	1
*SD633L33G0	£5954	€6848	3 x 7.5kW	3 x 18	3	3
*SD633L13G0	£5954	€6848	3 x 7.5kW	3 x 18	1	3
*SD633H31G0	£6254	€7193	3 x 11kW	3 x 20	3	1
*SD633H33G0	£6254	€7193	3 x 11kW	3 x 20	3	3

	PRICE £	PRICE €	DESCRIPTION
0*	£2271	€2612	Single oil return pump
0*	£6585	€7573	Triple oil return pump

Without Gravity Filtration

MODEL	PRICE £	PRICE €	POWER	OUTPUT /HR (kg)**	PHASE	SUPPLY CABLES
*SD633L31N0	£5343	€6145	3 x 7.5kW	3 x 18	3	1
*SD633L33N0	£5343	€6145	3 x 7.5kW	3 x 18	3	3
*SD633L13N0	£5343	€6145	3 x 7.5kW	3 x 18	1	3
*SD633H31N0	£5646	€6493	3 x 11kW	3 x 20	3	1
*SD633H33N0	£5646	€6493	3 x 11kW	3 x 20	3	3

** 7mm Frozen Fries

*** No. of baskets shown in brackets are an available option. Please call for more details

0* Factory fitted option please request at point of ordering

* Please refer to pages F36 to F37 for electricity supply requirements

Add-on Items

Accessories, consumables, spares and options



SOLAS specification feature modified feet for secure fastening to the floor

Castors available on all freestanding fryers, except, for safety reasons, 211 models

A Accessory **C** Consumable * Factory fitted option
S Spare **O*** Option

Joining Strip

Joining strip to connect two or more fryers to reduce oil ingress.

Accessories					
CODE	PRODUCT RANGE	PRICE £	PRICE €	DESCRIPTION	
A FZ100831	Touch, Precision, Super Easy 211, 411, 422	£126	€145	Small basket	
S FZ211046	Touch, Precision, Super Easy 211, 422	£39.60	€45.55	Grid with handles	
S FZ101139	Touch, Precision, Super Easy 211, 422, 522	£139	€160	Stainless steel filter	
S FZ101142	Touch, Precision, Super Easy 211, 422, 522	£24.85	€28.60	Fine tissue filter support	
C FZ101158	Touch, Precision, Super Easy 211, 422, 522	£84.70	€97.45	Fine tissue filter	
S FZ211067	Touch, Precision, Super Easy	£84.60	€97.30	Basket support	
A FZ311067	Touch, Precision, Super Easy 311	£70	€81	Basket support for two small baskets	
S FZ101140	Touch, Precision, Super Easy 311, 411, 522, 622	£156.60	€180.10	Stainless steel filter	
S FZ101143	Touch, Precision, Super Easy 311, 411, 522, 622	£28.15	€32.40	Fine tissue filter support	
C FZ101159	Touch, Precision, Super Easy 311, 411, 522, 622	£95.90	€110.30	Fine tissue filter	
A FZ301093	Touch, Precision, Super Easy 311, 622	£126	€145	Small basket	
A FZ411048	Touch, Precision, Super Easy 411	£167	€193	Large basket	
A FZ211133	All Touch, Precision, Super Easy	£68.65	€78.95	Joining strip for connecting two or more fryers to reduce oil ingress	
S FZ300941	Eco 4	£34	€40	Basket	
S FZ300942	Eco 6	£37	€43	Basket	
S FZ300716/S	Frita+ 6, Profi+ 6, 6+6 and 10	£85	€98	Basket	
S FZ101010/S	Frita+ 8, Profi+ 8	£94	€109	Small basket	
S FZ300717/S	Frita+ 8, Profi+ 8	£117	€135	Large basket	
S FZ601138	Profi+ 10	£182.40	€209.80	Grid with handle	
A FSM1	Touch, Precision, Super Easy	£206	€237	Food segregation management pack	
A FLHD	Touch, Precision, Super Easy (Free standing models only)	£103	€119	Reversible door kit	

Profii+

As standard

Electronic
Temperature
ControlRotary
Control
Front

Professional performance from a compact, sturdy counter top fryer.

Limited space needn't limit your frying capability. Profii+ is a truly professional fryer. Profii+ offers the same output and features as the Basic+ range. Precise electronic temperature control, for example, maintains oil temperature to within $\pm 1^{\circ}\text{C}$ of the selected setting.

The control panel is front-mounted – much safer than having to reach over the fryer. Other features include a lid that cleverly slots in at the rear of the fryer. This provides safer storage as well as a convenient splashback and basket support. A front drain valve facilitates safe, easy drainage of used oil.

Ideally suited for use in

- Fine cuisine – Superb temperature control for consistently excellent results
- Restaurants – Consistently produce crisp, succulent, great tasting fried food

Benefits at a glance

- Counter top
- Powerful
- Highly responsive electronic control
- Enhanced operator safety
- Safe and easy to use front draining valve
- Durable



Profii+ 6



Profii+ 10



Profii+ 8+8



- A powerful counter top fryer capable of producing up to 25 kg of chips per hour
- Highly responsive digital electronic control able to maintain oil to +/-1°C of the temperature selected
- Enhanced operator safety with front mounted control panel
- Rear-mounted slot-in lid that also acts as a splashback and basket support
- Safe and easy to use front valve for draining off used oil
- One piece pressed stainless steel tank with rounded corners for increased durability and reduced cleaning times

Profi+ Single Tank Counter Top Electric Fryers



Profi + 6 Single Tank Counter Top Fryer

MODEL	PRICE £	PRICE €	POWER	OUTPUT /HR (kg)**	OIL CAP	NO. OF BASKETS	DIMENSIONS (mm)				WT
							H	W	D		
*650946	£1655	€1904	4.6kW	14	5-7 L	1	455	270	475	15	

Profi + 8 Single Tank Counter Top Fryer

MODEL	PRICE £	PRICE €	POWER	OUTPUT /HR (kg)**	OIL CAP	NO. OF BASKETS	DIMENSIONS (mm)				WT
							H	W	D		
*650947	£1812	€2084	6.9kW	22	8-9.5l	1	455	360	475	16	
*650957	£1812	€2084	6.9kW	22	8-9.5l	2	455	360	475	17	

Profi + 10 Single Tank Counter Top Fryer

MODEL	PRICE £	PRICE €	POWER	OUTPUT /HR (kg)**	OIL CAP	NO. OF BASKETS	DIMENSIONS (mm)				WT
							H	W	D		
*651068	£2426	€2790	6.9kW	20	12-15l	2	455	540	475	23	
*650948	£2426	€2790	9.2kW	25	12-15l	2	455	540	475	23	

Profi+ Twin Tank Counter Top Electric Fryers

- A powerful counter top fryer capable of producing 44 kg of chips per hour
- Highly responsive digital electronic control able to maintain oil to +/-1°C of the temperature selected
- Enhanced operator safety with front mounted control panel
- Rear-mounted slot-in lid that also acts as a splashback and basket support
- Safe and easy to use front valve for draining off used oil
- One piece pressed stainless steel tank with rounded corners for increased durability and reduced cleaning times



Profi + 6 + 6 Twin Tank Counter Top Fryer

MODEL	PRICE £	PRICE €	POWER	OUTPUT /HR (kg)**	OIL CAP	NO. OF BASKETS	DIMENSIONS (mm)				WT
							H	W	D		
*650950	£3181	€3659	2x4.6kW	2 x 14	2 x 5-7 L	2	455	540	475	25	

Profi + 8 + 8 Twin Tank Counter Top Fryer

MODEL	PRICE £	PRICE €	POWER	OUTPUT /HR (kg)**	OIL CAP	NO. OF BASKETS	DIMENSIONS (mm)				WT
							H	W	D		
*650952	£3395	€3905	2x6.9kW	2 x 22	2x8-9.5L	2	455	720	475	30	
*650963	£3395	€3905	2x6.9kW	2 x 22	2x8-9.5L	4	455	720	475	30	

** 7mm Frozen Fries

All Profi+ models are three phase, 400 volt, however we can customise the voltage to suit your requirements. Please call for alternative voltages.

* Please refer to pages F36 to F37 for electricity supply requirements

lincat.co.uk

2023

As standard (Frita+)



Electronic Temperature Control



Rotary Control Front

As standard (Eco)



Electronic Temperature Control



Rotary Control Rear

frita+ & eco

Affordable, durable and efficient – they won't let you down



Frita+ fryers share many of the design details of the Profi+ range. These include a safe, easy-to-use front valve for draining off used oil and the rear-mounted slot-in lid that also acts as a splashback and basket support. Operator safety is further enhanced by the front-mounted control panel.

All Eco and Frita+ models incorporate a mechanical thermostat for maintaining oil to within +/-8°C of the temperature selected.

Ideally suited for use in

- Cafes – effortlessly produce fries to support your menu offering
- Pubs – ideal for cooking highly flavoured menu items
- Restaurants – cater for special dietary needs with this standalone fryer

Benefits at a glance

- Durable
- Efficient
- Well designed fryers
- Mechanical thermostat



Frita+ 6



Eco 6+6



- A durable, efficient and well designed fryer that won't let you down
- Mechanical thermostat for maintaining oil temperature to within +/-8 °C of the temperature set
- Enhanced operator safety with front mounted control panel
- Rear-mounted slot-in lid that also acts as a splashback and basket support
- Safe and easy to use front valve for draining off used oil
- One piece pressed stainless steel tank with rounded corners for increased durability and reduced cleaning times

Frita+ Single Tank Counter Top Electric Fryers



Frita + 6 Single Tank Counter Top Fryer										
MODEL	PRICE £	PRICE €	POWER	OUTPUT /HR (kg)**	OIL CAP	NO. OF BASKETS	DIMENSIONS (mm)			WT
							H	W	D	
*652000	£1128	€1298	4.6kW	10.5	5-7L	1	455	270	475	14

Frita + 8 Single Tank Counter Top Fryer										
MODEL	PRICE £	PRICE €	POWER	OUTPUT /HR (kg)**	OIL CAP	NO. OF BASKETS	DIMENSIONS (mm)			WT
							H	W	D	
*652001	£1296	€1491	6.9kW	16.5	8-9.5L	2	455	360	475	16
*652004	£1296	€1491	6.9kW	16.5	8-9.5L	1	455	360	475	16

All Frita+ models are three phase, 400 volt, however we can customise the voltage to suit your requirements. Please call for alternative voltages.

Eco Single Tank Counter Top Electric Fryers

- Ideal for the supply of portions of chips, as an occasional fryer or for cooking highly flavoured food
- Mechanical thermostat for maintaining oil temperature to within +/-8 °C of the temperature set
- One piece pressed stainless steel tank with rounded corners and lift-out control panel for reduced cleaning times



Eco 4 Single Tank Counter Top Fryer										
MODEL	PRICE £	PRICE €	POWER	OUTPUT /HR (kg)**	OIL CAP	NO. OF BASKETS	DIMENSIONS (mm)			WT
							H	W	D	
*650102	£392	€451	2.3kW	5.4	3-4L	1	295	203	375	5
*650101	†£397	€457	3.2kW	6	3-4L	1	295	203	375	5

Eco 6 Single Tank Counter Top Fryer										
MODEL	PRICE £	PRICE €	POWER	OUTPUT /HR (kg)**	OIL CAP	NO. OF BASKETS	DIMENSIONS (mm)			WT
							H	W	D	
*650105	†£456	€525	3.2kW	7	4-5L	1	295	254	375	6

Eco Twin Tank Counter Top Electric Fryers

- Ideal for the supply of portions of chips, as an occasional fryer or for cooking highly flavoured food
- Mechanical thermostat for maintaining oil temperature to within +/-8 °C of the temperature set
- One piece pressed stainless steel tank with rounded corners and lift-out control panel for reduced cleaning times



Eco 4 + 4 Twin Tank Counter Top Fryer										
MODEL	PRICE £	PRICE €	POWER	OUTPUT /HR (kg)**	OIL CAP	NO. OF BASKETS	DIMENSIONS (mm)			WT
							H	W	D	
*650104	£753	€866	2x 2.3kW	2 x 5.4	2 x 3-4L	2	295	384	375	10
*650103	†£758	€872	2x 3.2kW	2 x 6	3 x 3-4L	2	295	384	375	10

Eco 6 + 6 Twin Tank Counter Top Fryer										
MODEL	PRICE £	PRICE €	POWER	OUTPUT /HR (kg)**	OIL CAP	NO. OF BASKETS	DIMENSIONS (mm)			WT
							H	W	D	
*650106	†£879	€1011	2x 3.2kW	2 x 7	2 x 4-5L	2	295	486	375	11

** 7mm Frozen Fries

All Eco models are single phase, 230 volt. † Not available in the UK.

* Please refer to pages F36 to F37 for electricity supply requirements



Silofrit

Crisp, succulent, piping hot fries every time.



Silofrit chip scuttles ensure fries remain hot and crispy for longer – a real bonus during busy periods.

Silofrit offers counter top, free standing and built in models, all manufactured in durable 304 grade stainless steel. Fries are kept piping hot and crispy by the infra-red lamp above and by a drain plate and element* located beneath.

For added convenience the removable gastronorm/container and drain plate can be cleaned in the dishwasher.

*Excludes built-in model

Ideally suited for use in

- Quick Service Restaurant – providing a continuous supply of hot and crispy fries during busy periods
- Restaurants – great tasting, crisp, succulent, piping hot fries on demand

Benefits at a glance

- Free standing, counter top and built in models available
- Crisp, delicious, piping hot fries every time
- Removable gastronorm and drain plate can be cleaned in the dishwasher
- Manufactured in durable 304 grade stainless steel

Silofrit Chip Scuttles



Silofrit Free Standing Chip Scuttle

MODEL	PRICE £	PRICE €	POWER	DIMENSIONS (mm)			WT
				H	W	D	
601210	£3034	€3490	1kW	1155	400	620	46

Silofrit Counter Top Chip Scuttle

MODEL	PRICE £	PRICE €	POWER	DIMENSIONS (mm)			WT
				H	W	D	
650722	£1837	€2113	1kW	540	400	620	21

Silofrit Built In Chip Scuttle

MODEL	PRICE £	PRICE €	POWER	DIMENSIONS (mm)			WT
				H	W	D	
651105	£1808	€2080	0.65kW	455	400	630	12

Super*easy pasta

As standard



Thermostatic Temperature Control



Rotary Control Front

Optional



SOLAS Specification Option

Designed and built to ensure longer life in the harshest of conditions.



Experienced chefs and independent kitchens really appreciate the quality, performance and outstanding value of the Super Easy 311 pasta cooker.

With built in and free standing models available, the tank pressed from a single piece of superior grade 316 stainless steel and incoloy heating element provide superior resistance to punishing salt and starch corrosion at high temperatures.

Pasta cookers listed are 3 phase, 400 volt, however we can customise the voltage to suit your requirements.

High outputs of pasta enable you to keep pace with demand, even during peak periods

Ideally suited for use in

- Quick Service Restaurants – smaller baskets enable smaller portions to be cooked in constant rotation
- Restaurants – serve perfect pasta each and every time

Benefits at a glance

- Free standing and built in models available
- Designed and built to ensure longer life in the harshest of conditions
- Enables you to cook all types of pasta reliably and consistently with great results

- High outputs of pasta enable you to keep pace with demand, even during peak periods
- Optional smaller baskets enable smaller portions to be cooked in constant rotation maximising output and efficiency
- Plumbed to fresh water supply and waste for quick, easy filling and drainage of tank
- Starch removal keeps water fresh for longer to ensure perfect results
- Two tilt position elements to aid draining and cleaning

Super Easy Pasta Cookers



Super Easy Pasta 311 Free Standing Pasta Cooker								
MODEL	PRICE £	PRICE €	POWER	OUTPUT /HR (kg)**	DIMENSIONS (mm)			WT
					H	W	D	
*680131/A500	£3886	€4469	7.5kW	14	990	300	650	70

** Fresh Penne Pasta

Super Easy Pasta 311 Built In Pasta Cooker								
MODEL	PRICE £	PRICE €	POWER	OUTPUT /HR (kg)**	DIMENSIONS (mm)			WT
					H	W	D	
*690132/A700	£3816	€4389	7.5kW	14	875	300	630	42

** Fresh Penne Pasta

MODEL	PRICE £	PRICE €	DESCRIPTION
A DVC015ZR10	£147	€170	Single portion pasta basket
A DVC014ZR10	£262	€302	Basket for 311 pasta cookers
A FB2	£952	€1095	Basket with 6 single portion baskets for 311 pasta cookers

* Please refer to pages F36 to F37 for electricity supply requirements



Electricity Supply Requirements

Electrical products not listed on this page are supplied for operation on a 230/240v, 13 amp supply.

Brand	Product Code	Power Supply/ Connection Type	Electrical Supply Rating [watts]	Single Phase		Three Phase			
				Amps	Voltage	Amps - Phase 1	Amps - Phase 2	Amps - Phase 3	Voltage
FriFri	650101	1-phase	3,200	13.9	230				N/A
FriFri	650103	1-phase	2 x 3,200	2 x 13.9	230				N/A
FriFri	650105	1-phase	3,200	13.9	230				N/A
FriFri	650106	1-phase	2 x 3,200	2 x 13.9	230				N/A
FriFri	650946	3-phase	4,600	N/A		6.7	6.7	6.7	400
FriFri	650947	3-phase	6,900	N/A		10.0	10.0	10.0	400
FriFri	650948	3-phase	9,200	N/A		13.3	13.3	13.3	400
FriFri	650950	3-phase	2 x 4,600	N/A		2 x 6.7	2 x 6.7	2 x 6.7	400
FriFri	650952	3-phase	2 x 6,900	N/A		2 x 10.0	2 x 10.0	2 x 10.0	400
FriFri	650957	3-phase	6,900	N/A		10.0	10.0	10.0	400
FriFri	650963	3-phase	2 x 6,900	N/A		2 x 10.0	2 x 10.0	2 x 10.0	400
FriFri	651068	3-phase	6,900	N/A		10.0	10.0	10.0	400
FriFri	652000	3-phase	4,600	N/A		6.7	6.7	6.7	400
FriFri	652001	3-phase	6,900	N/A		10.0	10.0	10.0	400
FriFri	652004	3-phase	6,900	N/A		10.0	10.0	10.0	400
FriFri	680131/A500	3-phase	7,500	N/A		10.9	10.9	10.9	400
FriFri	690132/A700	3-phase	7,500	N/A		10.9	10.9	10.9	400
FriFri	PD211H31G0	3-phase	11,000	N/A		15.9	15.9	15.9	400
FriFri	PD211L11G0	1-phase	7500	32.6	230				N/A
FriFri	PD211L31G0	3-phase	7,500	N/A		10.9	10.9	10.9	400
FriFri	PD211M11G0	1-phase	9000	39.1	230				N/A
FriFri	PD211M31G0	3-phase	9,000	N/A		13.0	13.0	13.0	400
FriFri	PD311H31G0	3-phase	15,000	N/A		21.7	21.7	21.7	400
FriFri	PD311L31G0	3-phase	11,400	N/A		16.5	16.5	16.5	400
FriFri	PD412H31G0	3-phase	22,000	N/A		31.9	31.9	31.9	400
FriFri	PD412L31G0	3-phase	15,000	N/A		21.7	21.7	21.7	400
FriFri	PD412M31G0	3-phase	18,000	N/A		26.1	26.1	26.1	400
FriFri	PD422H32G0	3-phase	2 x 11,000	N/A		2 x 15.9	2 x 15.9	2 x 15.9	400
FriFri	PD422L12G0	1-phase	2 x 7500	2 x 32.6	230				N/A
FriFri	PD422L32G0	3-phase	2 x 7,500	N/A		2 x 10.9	2 x 10.9	2 x 10.9	400
FriFri	PD422M12G0	1-phase	2 x 9000	2 x 39.1	230				N/A
FriFri	PD422M32G0	3-phase	2 x 9,000	N/A		2 x 13.0	2 x 13.0	2 x 13.0	400
FriFri	PD522L32G0	3-phase	11,400; 7,500	N/A		16.5 + 10.9	16.5 + 10.9	16.5 + 10.9	400
FriFri	PD522M32G0	3-phase	11,400; 9,000	N/A		16.5 + 13.0	16.5 + 13.0	16.5 + 13.0	400
FriFri	PD622H32G0	3-phase	2 x 15,000	N/A		2 x 21.7	2 x 21.7	2 x 21.7	400
FriFri	PD622L32G0	3-phase	2 x 11,400	N/A		2 x 16.5	2 x 16.5	2 x 16.5	400
FriFri	PD633L13G0	1-phase	3 x 7,500	3 x 32.6	230				N/A
FriFri	PD633L31G0	3-phase	22,500	N/A		32.6	32.6	32.6	400
FriFri	PD633L33G0	3-phase	3 x 7,500	N/A		3 x 10.9	3 x 10.9	3 x 10.9	400
FriFri	PD633M13G0	1-phase	3 x 9,000	3 x 39.1	230				N/A
FriFri	PD633M31G0	3-phase	27,000	N/A		39.1	39.1	39.1	400
FriFri	PD633M33G0	3-phase	3 x 9,000	N/A		3 x 13.0	3 x 13.0	3 x 13.0	400
FriFri	PL211H31G0	3-phase	11,000	N/A		15.9	15.9	15.9	400
FriFri	PL211L11G0	1-phase	7500	32.6	230				N/A
FriFri	PL211L31G0	3-phase	7,500	N/A		10.9	10.9	10.9	400
FriFri	PL211M11G0	1-phase	9000	39.1	230				N/A
FriFri	PL211M31G0	3-phase	9,000	N/A		13.0	13.0	13.0	400
FriFri	PL311H31G0	3-phase	15,000	N/A		21.7	21.7	21.7	400
FriFri	PL311L31G0	3-phase	11,400	N/A		16.5	16.5	16.5	400
FriFri	PL412H31G0	3-phase	22,000	N/A		31.9	31.9	31.9	400
FriFri	PL412L31G0	3-phase	15,000	N/A		21.7	21.7	21.7	400
FriFri	PL412M31G0	3-phase	18,000	N/A		26.1	26.1	26.1	400
FriFri	PL422H32G0	3-phase	2 x 11,000	N/A		2 x 15.9	2 x 15.9	2 x 15.9	400
FriFri	PL422L12G0	1-phase	2 x 7500	2 x 32.6	230				N/A
FriFri	PL422L32G0	3-phase	2 x 7,500	N/A		2 x 10.9	2 x 10.9	2 x 10.9	400
FriFri	PL422M12G0	1-phase	2 x 9000	2 x 39.1	230				N/A
FriFri	PL422M32G0	3-phase	2 x 9,000	N/A		2 x 13.0	2 x 13.0	2 x 13.0	400
FriFri	PL622H32G0	3-phase	2 x 15,000	N/A		2 x 21.7	2 x 21.7	2 x 21.7	400
FriFri	PL622L32G0	3-phase	2 x 11,400	N/A		2 x 16.5	2 x 16.5	2 x 16.5	400
FriFri	PL633L13G0	1-phase	3 x 7,500	3 x 32.6	230				N/A
FriFri	PL633L31G0	3-phase	22,500	N/A		32.6	32.6	32.6	400
FriFri	PL633L33G0	3-phase	3 x 7,500	N/A		3 x 10.9	3 x 10.9	3 x 10.9	400
FriFri	PL633M13G0	1-phase	3 x 9,000	3 x 39.1	230				N/A
FriFri	PL633M31G0	3-phase	27,000	N/A		39.1	39.1	39.1	400
FriFri	PL633M33G0	3-phase	3 x 9,000	N/A		3 x 13.0	3 x 13.0	3 x 13.0	400
FriFri	SD211H31G0	3-phase	11,000	N/A		15.9	15.9	15.9	400
FriFri	SD211H31N0	3-phase	11,000	N/A		15.9	15.9	15.9	400
FriFri	SD211L11G0	1-phase	7500	32.6	230				N/A
FriFri	SD211L11N0	1-phase	7500	32.6	230				N/A
FriFri	SD211L31G0	3-phase	7,500	N/A		10.9	10.9	10.9	400
FriFri	SD211L31N0	3-phase	7,500	N/A		10.9	10.9	10.9	400
FriFri	SD311H31G0	3-phase	15,000	N/A		21.7	21.7	21.7	400
FriFri	SD311H31N0	3-phase	15,000	N/A		21.7	21.7	21.7	400
FriFri	SD311L31G0	3-phase	11,400	N/A		16.5	16.5	16.5	400
FriFri	SD311L31N0	3-phase	11,400	N/A		16.5	16.5	16.5	400
FriFri	SD412H31G0	3-phase	22,000	N/A		31.9	31.9	31.9	400
FriFri	SD412H31N0	3-phase	22,000	N/A		31.9	31.9	31.9	400
FriFri	SD412L31G0	3-phase	15,000	N/A		21.7	21.7	21.7	400
FriFri	SD412L31N0	3-phase	15,000	N/A		21.7	21.7	21.7	400
FriFri	SD422H32G0	3-phase	2 x 11,000	N/A		2 x 15.9	2 x 15.9	2 x 15.9	400
FriFri	SD422H32N0	3-phase	2 x 11,000	N/A		2 x 15.9	2 x 15.9	2 x 15.9	400
FriFri	SD422L12G0	1-phase	2 x 7500	2 x 32.6	230				N/A
FriFri	SD422L12N0	1-phase	2 x 7500	2 x 32.6	230				N/A
FriFri	SD422L31G0	3-phase	15,000	N/A		21.7	21.7	21.7	400
FriFri	SD422L31N0	3-phase	15,000	N/A		21.7	21.7	21.7	400
FriFri	SD622H32G0	3-phase	2 x 15,000	N/A		2 x 21.7	2 x 21.7	2 x 21.7	400
FriFri	SD622H32N0	3-phase	2 x 15,000	N/A		2 x 21.7	2 x 21.7	2 x 21.7	400
FriFri	SD622L32G0	3-phase	2 x 11,400	N/A		2 x 16.5	2 x 16.5	2 x 16.5	400
FriFri	SD622L32N0	3-phase	2 x 11,400	N/A		2 x 16.5	2 x 16.5	2 x 16.5	400
FriFri	SD633H31G0	3-phase	33,000	N/A		47.8	47.8	47.8	400
FriFri	SD633H31N0	3-phase	33,000	N/A		47.8	47.8	47.8	400
FriFri	SD633H33G0	3-phase	3 x 11,000	N/A		3 x 15.9	3 x 15.9	3 x 15.9	400

Electricity Supply Requirements

Electrical products not listed on this page are supplied for operation on a 230/240v, 13 amp supply.

Brand	Product Code	Power Supply/ Connection Type	Electrical Supply Rating [watts]	Single Phase		Three Phase				
				Amps	Voltage	Amps - Phase 1	Amps - Phase 2	Amps - Phase 3	Voltage	
FriFri	SD633H33N0	3-phase	3 x 11,000		N/A					400
FriFri	SD633L13G0	1-phase	3 x 7,500	3 x 32.6	230				N/A	
FriFri	SD633L13N0	1-phase	3 x 7,500	3 x 32.6	230				N/A	
FriFri	SD633L31G0	3-phase	22,500		N/A	32.6	32.6	32.6		400
FriFri	SD633L31N0	3-phase	22,500		N/A	32.6	32.6	32.6		400
FriFri	SD633L33G0	3-phase	3 x 7,500		N/A	3 x 10.9	3 x 10.9	3 x 10.9		400
FriFri	SD633L33N0	3-phase	3 x 7,500		N/A	3 x 10.9	3 x 10.9	3 x 10.9		400
FriFri	SL211H31G0	3-phase	11,000		N/A	15.9	15.9	15.9		400
FriFri	SL211H31N0	3-phase	11,000		N/A	15.9	15.9	15.9		400
FriFri	SL211L11G0	1-phase	7500	32.6	230				N/A	
FriFri	SL211L11N0	1-phase	7500	32.6	230				N/A	
FriFri	SL211L31G0	3-phase	7,500		N/A	10.9	10.9	10.9		400
FriFri	SL211L31N0	3-phase	7,500		N/A	10.9	10.9	10.9		400
FriFri	SL311H31G0	3-phase	15,000		N/A	21.7	21.7	21.7		400
FriFri	SL311H31N0	3-phase	15,000		N/A	21.7	21.7	21.7		400
FriFri	SL311L31G0	3-phase	11,400		N/A	16.5	16.5	16.5		400
FriFri	SL311L31N0	3-phase	11,400		N/A	16.5	16.5	16.5		400
FriFri	SL412H31G0	3-phase	22,000		N/A	31.9	31.9	31.9		400
FriFri	SL412H31N0	3-phase	22,000		N/A	31.9	31.9	31.9		400
FriFri	SL412L31G0	3-phase	15,000		N/A	21.7	21.7	21.7		400
FriFri	SL412L31N0	3-phase	15,000		N/A	21.7	21.7	21.7		400
FriFri	SL422H32G0	3-phase	2 x 11,000		N/A	2 x 15.9	2 x 15.9	2 x 15.9		400
FriFri	SL422H32N0	3-phase	2 x 11,000		N/A	2 x 15.9	2 x 15.9	2 x 15.9		400
FriFri	SL422L12G0	1-phase	2 x 7500	2 x 32.6	230				N/A	
FriFri	SL422L12N0	1-phase	2 x 7500	2 x 32.6	230				N/A	
FriFri	SL422L31G0	3-phase	15,000		N/A	21.7	21.7	21.7		400
FriFri	SL422L31N0	3-phase	15,000		N/A	21.7	21.7	21.7		400
FriFri	SL622H32G0	3-phase	2 x 15,000		N/A	2 x 21.7	2 x 21.7	2 x 21.7		400
FriFri	SL622H32N0	3-phase	2 x 15,000		N/A	2 x 21.7	2 x 21.7	2 x 21.7		400
FriFri	SL622L32G0	3-phase	2 x 11,400		N/A	2 x 16.5	2 x 16.5	2 x 16.5		400
FriFri	SL622L32N0	3-phase	2 x 11,400		N/A	2 x 16.5	2 x 16.5	2 x 16.5		400
FriFri	SL633H31G0	3-phase	33000		N/A	47.8	47.8	47.8		400
FriFri	SL633H31N0	3-phase	33000		N/A	47.8	47.8	47.8		400
FriFri	SL633H33G0	3-phase	3 x 11,000		N/A	3 x 15.9	3 x 15.9	3 x 15.9		400
FriFri	SL633H33N0	3-phase	3 x 11,000		N/A	3 x 15.9	3 x 15.9	3 x 15.9		400
FriFri	SL633L13G0	1-phase	3 x 7,500	3 x 32.6	230				N/A	
FriFri	SL633L13N0	1-phase	3 x 7,500	3 x 32.6	230				N/A	
FriFri	SL633L31G0	3-phase	22500		N/A	32.6	32.6	32.6		400
FriFri	SL633L31N0	3-phase	22500		N/A	32.6	32.6	32.6		400
FriFri	SL633L33G0	3-phase	3 x 7,500		N/A	3 x 10.9	3 x 10.9	3 x 10.9		400
FriFri	SL633L33N0	3-phase	3 x 7,500		N/A	3 x 10.9	3 x 10.9	3 x 10.9		400
FriFri	TD211H31G0	3-phase	11,000		N/A	15.9	15.9	15.9		400
FriFri	TD211L11G0	1-phase	7500	32.6	230				N/A	
FriFri	TD211L31G0	3-phase	7,500		N/A	10.9	10.9	10.9		400
FriFri	TD211M11G0	1-phase	9000	39.1	230				N/A	
FriFri	TD211M31G0	3-phase	9,000		N/A	13.0	13.0	13.0		400
FriFri	TD311H31G0	3-phase	15,000		N/A	21.7	21.7	21.7		400
FriFri	TD311L31G0	3-phase	11,400		N/A	16.5	16.5	16.5		400
FriFri	TD412H31G0	3-phase	22,000		N/A	31.9	31.9	31.9		400
FriFri	TD412L31G0	3-phase	15,000		N/A	21.7	21.7	21.7		400
FriFri	TD412M31G0	3-phase	18,000		N/A	26.1	26.1	26.1		400
FriFri	TD422H32G0	3-phase	2 x 11,000		N/A	2 x 15.9	2 x 15.9	2 x 15.9		400
FriFri	TD422L12G0	1-phase	2 x 7500	2 x 32.6	230				N/A	
FriFri	TD422L32G0	3-phase	2 x 7,500		N/A	2 x 10.9	2 x 10.9	2 x 10.9		400
FriFri	TD422M12G0	1-phase	2 x 9000	2 x 39.1	230				N/A	
FriFri	TD422M32G0	3-phase	2 x 9,000		N/A	2 x 13.0	2 x 13.0	2 x 13.0		400
FriFri	TD522L32G0	3-phase	11,400; 7,500		N/A	16.5 + 10.9	16.5 + 10.9	16.5 + 10.9		400
FriFri	TD522M32G0	3-phase	11,400; 9,000		N/A	16.5 + 13.0	16.5 + 13.0	16.5 + 13.0		400
FriFri	TD622H32G0	3-phase	2 x 15,000		N/A	2 x 21.7	2 x 21.7	2 x 21.7		400
FriFri	TD622L32G0	3-phase	2 x 11,400		N/A	2 x 16.5	2 x 16.5	2 x 16.5		400
FriFri	TD633L13G0	1-phase	3 x 7,500	3 x 32.6	230				N/A	
FriFri	TD633L31G0	3-phase	22,500		N/A	32.6	32.6	32.6		400
FriFri	TD633L33G0	3-phase	3 x 7,500		N/A	3 x 10.9	3 x 10.9	3 x 10.9		400
FriFri	TD633M13G0	1-phase	3 x 9,000	3 x 39.1	230				N/A	
FriFri	TD633M31G0	3-phase	27,000		N/A	32.6	32.6	32.6		400
FriFri	TD633M33G0	3-phase	3 x 9,000		N/A	3 x 10.9	3 x 10.9	3 x 10.9		400
FriFri	TL211H31G0	3-phase	11,000		N/A	15.9	15.9	15.9		400
FriFri	TL211L11G0	1-phase	7500	32.6	230				N/A	
FriFri	TL211L31G0	3-phase	7,500		N/A	10.9	10.9	10.9		400
FriFri	TL211M11G0	1-phase	9000	39.1	230				N/A	
FriFri	TL211M31G0	3-phase	9,000		N/A	13.0	13.0	13.0		400
FriFri	TL311H31G0	3-phase	15,000		N/A	21.7	21.7	21.7		400
FriFri	TL311L31G0	3-phase	11,400		N/A	16.5	16.5	16.5		400
FriFri	TL412H31G0	3-phase	22,000		N/A	31.9	31.9	31.9		400
FriFri	TL412L31G0	3-phase	15,000		N/A	21.7	21.7	21.7		400
FriFri	TL412M31G0	3-phase	18,000		N/A	26.1	26.1	26.1		400
FriFri	TL422H32G0	3-phase	2 x 11,000		N/A	2 x 15.9	2 x 15.9	2 x 15.9		400
FriFri	TL422L12G0	1-phase	2 x 7500	2 x 32.6	230				N/A	
FriFri	TL422L32G0	3-phase	2 x 7,500		N/A	2 x 10.9	2 x 10.9	2 x 10.9		400
FriFri	TL422M12G0	1-phase	2 x 9000	2 x 39.1	230				N/A	
FriFri	TL422M32G0	3-phase	2 x 9,000		N/A	2 x 13.0	2 x 13.0	2 x 13.0		400
FriFri	TL622H32G0	3-phase	2 x 15,000		N/A	2 x 21.7	2 x 21.7	2 x 21.7		400
FriFri	TL622L32G0	3-phase	2 x 11,400		N/A	2 x 16.5	2 x 16.5	2 x 16.5		400
FriFri	TL633L13G0	1-phase	3 x 7,500	3 x 32.6	230				N/A	
FriFri	TL633L31G0	3-phase	22500		N/A	32.6	32.6	32.6		400
FriFri	TL633L33G0	3-phase	3 x 7,500		N/A	3 x 10.9	3 x 10.9	3 x 10.9		400
FriFri	TL633M13G0	1-phase	3 x 9,000	3 x 39.1	230				N/A	
FriFri	TL633M31G0	3-phase	27000		N/A	32.6	32.6	32.6		400
FriFri	TL633M33G0	3-phase	3 x 9,000		N/A	3 x 10.9	3 x 10.9	3 x 10.9		400

All weights stated are packed weights.

Warning UK: In accordance with The Gas Safety (Installation and Use Amendment Regulations 1998) gas appliances must be installed by commercial catering equipment engineers certified by the Gas Safety Register. Failure to comply with this will render any non registered installer liable to prosecution and will invalidate the guarantee.

For Sale terms and conditions please visit lincat.co.uk/sale-terms-conditions



imc

fresh thinking

PRODUCT RANGE & PRICE LIST



SPECIALISING IN

- BAR SYSTEMS
- VEGETABLE PREPARATION
- WASTE MANAGEMENT
- CLEANING AND RINSING

Contents



Bar Systems and Refrigeration

Under Bar Systems, Bottle Coolers and Glass Frosters

Ideally suited for:

Bars, restaurants, hotels, cafes and coffee shops: Speed up service and generate customer satisfaction with great-tasting drinks.

Why choose IMC Under Bar Systems, Bottle Coolers and Glass Frosters?

- Maximise serving speed and efficiency
- Bartender's wide range of modules and accessories are available to meet all your needs
- Great tasting drinks
- Quick and easy access
- Energy efficient models
- Choice of exterior colours and door options
- Available in a variety of sizes to suit the scale of your operation

Find out more on page

i3



Vegetable Preparation

Peelers and Chippers

Ideally suited for:

Fish and chip shops, pubs, restaurants and fast food outlets, prepare a high volume of vegetables at speed with IMC's vegetable preparation solutions.

Why choose IMC Vegetable Preparation Equipment?

- Peel and prepare vegetables at speed
- Increase the efficiency of your kitchen
- Simple and safe to operate
- Easy to load
- Easy to maintain
- Easy to clean
- Robustly engineered
- Provides minimal waste

Find out more on page

i57



Waste Management

Food Waste Disposers and Waste Compactors

Ideally suited for:

Pubs & bars, nursing homes, hospitals and factories. Create a cleaner, safer working environment and save time and money, by investing in efficient waste management equipment.

Why choose IMC Waste Management Equipment

- Compact and efficient
- Remove waste quickly
- Safe and easy operation
- Reduces costs, saves time

Find out more on page

i73



Cleaning and Rinsing

Pan Scrubbers and Mobile Cleansing Stations

Ideally suited for:

Restaurants and cafes, outdoor catering, cost sector: meet stringent hygiene standards and save valuable staff time, with effective cleaning and rinsing solutions.

Why choose IMC Cleaning and Rinsing Equipment?

- Effective removal of food debris
- Saves time and increases efficiency
- Safe and easy to use
- Ideal for organisations looking to extend hand washing facilities
- Helps meet health and safety, and hygiene standards

Find out more on page

i91

All prices are exclusive of VAT.

UK

Goods are normally delivered free of charge to either the dealers' address or direct within 3 working days. If overnight and/or premium services are required charges will apply.

Export

Goods are priced ex works, export crates POA.

Any units which are built to order or include factory fit options are non-returnable.

☎ UK Tel: 01522 875500

☎ Export Tel: +44 1522 503250

✉ UK e-mail: sales@lincat.co.uk

✉ Export e-mail: export@lincat.co.uk



2
YEAR

UK parts
and labour
warranty

Export
parts
warranty

on all IMC products

Bar Systems & Refrigeration

Under Bar Systems • Bottle coolers • Glass Frosters



Our comprehensive range of commercial under bar and refrigeration equipment is designed to meet the needs of every restaurant, bar and café regardless of shape, size or budget.

The bar-workstation concept is unique to IMC and epitomised in Bartender, our under bar system. From draught pumps to cocktail ingredients, glasses to cash till, everything is ergonomically positioned to minimise movement of bar staff and maximise serving speed and efficiency.

With precise temperature control and rapid chill, our energy-efficient bottle coolers are the perfect showcase for drinks. Across three ranges - Ventus, Mistral and BM - all models allow easy access

for quick service and are available in a range of stylish designs and space-saving sizes.

With rapid chill, our energy-efficient range of glass frosters helps bars to deliver high-quality drinks every time. With three ranges to choose from - Ventus, Mistral and Frostar - each froster provides easy access for quick service and is available in a range of sleek designs, with varying capacities.

Ideally suited for...



Bars

Speed up service and generate customer satisfaction with efficient service and great tasting drinks.



Restaurants

Enhance your customers' dining experience by serving high-quality drinks alongside delicious food.



Hotels

Attract customers in your hotel's bar with great service, stylish bottle coolers and glass frosters. Show your drinks in their best light in a well-designed unit that enhances your offer.



Cafes and coffee shops

Encourage customers to spend by tempting them with well-presented drinks. Highlight your offer and ensure great tasting beverages with a Mistral bottle cooler.

Benefits at a glance

- Maximise serving speed and efficiency
- Bartender's wide range of modules and accessories are available to meet all your needs
- Energy efficient coolers with rapid chill for quick service
- Bottle coolers and frosters available in a choice of exterior colours and door options

Bottle Coolers

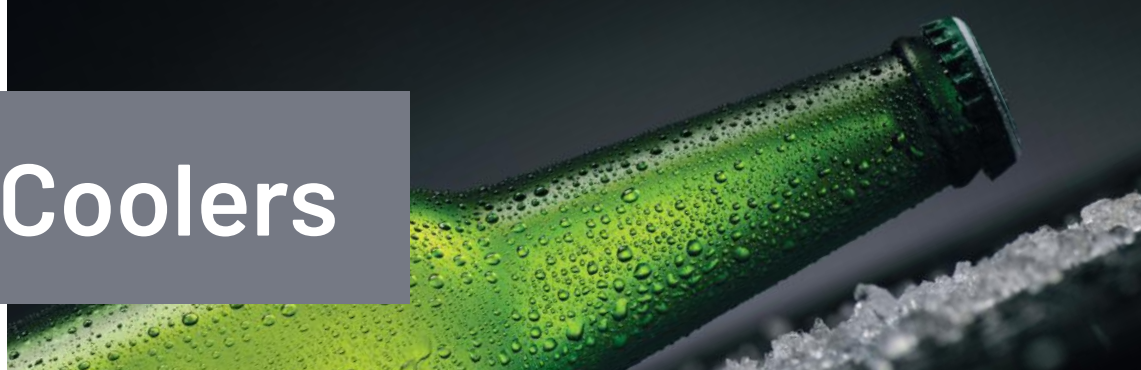

	Ventus						Mistral						BM	BM Bartender
	V60	V60 (FULL FRONT)	V90	V90 (FULL FRONT)	V135	V135 (FULL FRONT)	M60	M60 (HIGH AMBIENT)	M90	M90 (HIGH AMBIENT)	M135	TC60	BM70	BM70
PAGE	i20 - i23	i24 - i26	i27 - i30	i31 - i33	i34 - i35	i36 - i37	i44	i45	i46	i48	i49	i50	i54	i54
DIMENSIONS														
HEIGHT (mm)	900/850/ 800	900/850/ 800	900/850/ 800	900/850/ 800	900/800	900/800	900/850/ 800	900	900/850/ 800	900	900/800	1850	875	950
WIDTH (mm)	600	600	900	900	1350	1350	600	600	900	900	1350	600	700	700
DEPTH (mm)	500/450	500	500/450	500	500	500	500	500	500	500	500	500	560	560
ACCESS														
SIDE LOADING	✓	✓	✓	✓	✓	✓	✓	✓	✓	✓	✓	✓	-	-
TOP LOADING	-	-	-	-	-	-	-	-	-	-	-	-	✓	✓
BOTTLE CAPACITY														
800mm HIGH	78	78	117	117	185	185	78	-	117	-	185	-	-	-
850mm HIGH	78	78	117	117	-	-	78	-	117	-	-	-	-	-
900mm HIGH (SIDE OPENING)	120	120	195	195	310	310	120	-	195	-	310	-	-	-
900mm HIGH (SLIDING DOOR)	-	-	-	-	-	-	-	-	204	-	-	-	-	-
450mm DEPTH	96	-	156	-	-	-	-	-	-	-	-	-	-	-
HIGH AMBIENT	-	-	-	-	-	-	135	136	204	204	-	-	-	-
1850mm HIGH	-	-	-	-	-	-	-	-	-	-	-	272	-	-
BM/BM BARTENDER	-	-	-	-	-	-	-	-	-	-	-	-	140	140
DOOR/S														
NUMBER OF DOORS	1	1	2	2	3	3	1	1	2	3	3	1	2	2
DOOR OPENING	Front Right, revers- ible	Front Right, revers- ible	Front Left, Right	Front Left, Right	Front Left, Right, Right	Front Left, Right, Right	Front	Front	Front	Front	Front	Front	Top	Top
DOOR HINGING	Right, revers- ible	Right, revers- ible	Left, Right	Left, Right	Left, Right, Right	Left, Right, Right	Right	Right	Left, Right	Left, Right	Left, Right, Right	Right, revers- ible	-	-
SLIDING DOOR MODEL	-	-	-	-	-	-	-	-	✓	-	-	-	-	-
DOOR FINISH														
STAINLESS STEEL	✓	✓	✓	✓	✓	✓	✓	✓	✓	✓	✓	✓	✓	✓
BLACK PAINTED	✓	✓	✓	✓	✓	✓	✓	-	✓	-	✓	✓	-	-
GLAZED DOOR OPTION	✓	✓	✓	✓	✓	✓	✓	✓	✓	✓	✓	✓	✓	✓
SOLID DOOR OPTION	✓	✓	✓	✓	✓	✓	-	✓	-	✓	-	✓	✓	✓
ACCEPTS CUSTOMERS OWN DOOR PANEL	✓	✓	✓	✓	✓	✓	-	-	-	-	-	✓	-	-
NUMBER OF SHELVES	2	2	2	2	2	2	2	2	2	2	2	5	2	2
NUMBER OF SHELF POSITIONS	29	29	29	29	29	29	29	29	29	29	29	95	2	2
WINE SHELF AVAILABLE	✓	✓	✓	✓	✓	✓	✓	✓	✓	✓	✓	✓	-	-
ADJUSTABLE OPERATING TEMPERATURE	2°C - 6°C	2°C - 6°C	2°C - 6°C	2°C - 6°C	2°C - 6°C	2°C - 6°C	2°C - 6°C	2°C - 6°C	2°C - 6°C	2°C - 6°C	2°C - 6°C	2°C - 6°C	2°C - 6°C	2°C - 6°C
INTERNAL LIGHTING	LED	LED	LED	LED	LED	LED	LED	LED	LED	LED	LED	LED	0	0
LOCK	✓	-	✓	-	✓	-	✓	✓	✓	✓	✓	✓*	✓	✓
BARTENDER COMPATIBLE	-	-	-	-	-	-	-	-	-	-	-	-	-	✓
REFRIGERANT TYPE	R290	R290	R290	R290	R290	R290	R290	R290	R290	R290	R290	R290	R290	R290

*Only on F77/510 Models

2 YEAR

UK parts
and labour
warranty

Export
parts
warranty

on all IMC products

Glass Frosters



	Ventus		Frostar
	VR60	VR60 (FULL FRONT)	FR60
PAGE	i38	i40	i56
DIMENSIONS			
HEIGHT (mm)	900/800	900/800	900
WIDTH (mm)	600	600	600
DEPTH (mm)	500	500	620
ACCESS			
SIDE LOADING	✓	✓	-
TOP LOADING	-	-	✓
GLASS CAPACITY (STANDARD PINT GLASS)			
800mm HIGH	50	50	-
900mm HIGH (SIDE OPENING DOORS)	50	50	-
900mm HIGH (TOP OPENING DOORS)	-	-	75
DOOR/S			
NUMBER OF DOORS	1	1	1
DOOR OPENING	Front	Front	Top
DOOR HINGING	Right, reversible	Right, reversible	-
DOOR FINISH			
STAINLESS STEEL	✓	✓	✓
BLACK PAINTED	✓	✓	✓
GLAZED DOOR OPTION	✓	✓	-
SOLID DOOR OPTION	✓	✓	-
ACCEPTS CUSTOMERS OWN DOOR PANEL	✓	✓	-
NUMBER OF SHELVES			
NUMBER OF SHELF POSITIONS	2	2	3
WINE SHELF AVAILABLE	✓	✓	-
OPERATING TEMPERATURE	-10°C Constant	-10°C Constant	-17°C Constant
INTERNAL LIGHTING	LED	LED	Fluorescent
LOCK	✓	✓	✓
REFRIGERANT TYPE	R290	R290	R290

2 YEAR
UK parts and labour warranty | Export parts warranty
on all IMC products

Contents



Bartender

Ergonomically equip bar staff to serve drinks in the most efficient way

Under Bar System

Ideally suited for:

Bars, restaurants and hotels. Speed up service and generate customer satisfaction with efficient service.

Why choose Bartender?

- Configured to maximise staff productivity and efficiency
- Boosts sales and improves profits
- Easy to clean and robust stainless steel construction
- A wide range of work stations, modules and accessories are available to meet all your needs
- Ensures your bar area conforms to Food Safety Regulations

Find out more on page **i7**



Ventus

The bespoke nature of Ventus makes it the ideal choice for a wide range of operations.

Bottle Coolers and Glass Frosters

Ideally suited for:

Clubs, hotels, cafes and coffee shops serve ice cold drinks with visual appeal with Ventus.

Why choose Ventus?

- Precise temperature control ensures drinks are kept at the optimum serving temperature
- Variety of space-saving sizes available, we're sure to have a solution perfect for any available space.
- Over 150 options available including lighting options, door finishes, handle options and gas types ensures we have a design to complement every bar setting.
- Economical running with the Dynamic Air Distribution System, and EcoSmart controller

Find out more on page **i17**



Mistral

With a choice of sizes and exterior finishes, there's a Mistral to suit any bar operation.

Bottle Coolers and Glass Frosters

Ideally suited for:

Bars, restaurants, clubs, hotels, cafes and coffee shops

Why choose Mistral?

- Precise temperature control and rapid chill ensures drinks are kept at the optimum serving temperature
- Perfect showcase for drinks - available in a range of designs and space-saving sizes
- Energy efficient

Find out more on page **i43**



bm

BOTTLE COOLERS

Serve perfectly-chilled drinks at speed with BM's top-loading bottle coolers.

Top-loading Bottle Coolers

Ideally suited for:

Bars, restaurants and clubs

Why choose BM?

- Top-loading design with sliding cover, ensures fast and easy access to ice cold drinks
- Rapid chill for quick service
- Precise temperature control
- Energy efficient
- UK 3 pin plug
- Stylish exterior design for underbar systems

Find out more on page **i53**



Frostar

Serve perfectly-presented, great-tasting drinks with speed with Frostar glass frosters

Top-loading Glass Frosters

Ideally suited for:

Bars, restaurants and clubs

Why choose Frostar?

- Top-loading with sliding cover for quick and easy access
- Chills and frosts glasses to add visual appeal to drinks
- Rapid cooling to -17°C
- Precise temperature control
- Stylish exterior design
- Large capacity

Find out more on page **i55**

Bartender



It may be invisible to customers but they'll see the difference in faster service, less harassed staff and an all-round better atmosphere.

Bartender provides an exciting opportunity to develop a dynamic, versatile and exciting under bar system. Configured to maximise staff productivity and efficiency – and therefore turnover of customers – Bartender boosts sales and improves profits.

The bar-workstation concept is unique to IMC and epitomised in Bartender. From draught pumps to cocktail ingredients, glasses to cash till, everything is ergonomically positioned to minimise movement of bar staff and maximise serving speed and efficiency.

Stainless steel is not only the most stylish solution available for an under bar system. It's also the most practical. Easy to clean and maintain, it can take the knocks in the busiest bars and stay looking pristine.

Central to the successful use of Bartender is the IMC concept of creating compact self-contained workstations. Each area then has everything required by individual bar staff, so they are instantly more efficient and productive. Keep this philosophy in mind when planning a Bartender bar, as it will help you reduce staff costs and boost sales.

Ideally suited for...



Bars

Speed up service and generate customer satisfaction with efficient service.



Restaurants

Enhance your customers' dining experience by serving high-quality drinks alongside delicious food.



Hotels

Attract customers in your hotel's bar with cocktails and great service!

Benefits at a glance

- Configured to maximise staff productivity and efficiency
- Boosts sales and improves profits
- A wide range of work stations, modules and accessories are available to meets all your needs
- Easy to clean and robust stainless steel construction
- Ensures your bar area conforms to Food Safety Regulations

Bartender

Endless possibilities in bar design

The Bartender section within this brochure is designed to provide an introduction to the choice of bar modules, options and accessories we offer. Whether your requirement for a bar is large or small our team of experienced in house designers are here to help develop the perfect bar solution for you.

Bar - Work Stations

IMC offer a complementary range of six bar-workstations that will create an immediate performance impact in any bar area. These stations will blend seamlessly with other Bartender units.



Cocktail Station

Single piece worktop design incorporating a blender station, waste unit, ice chest and shelf unit.

MODEL	PRICE £	PRICE €	WIDTH
BZ70/200	£5899	€6784	2000

2
YEAR

UK parts
and labour
warranty

Export
parts
warranty

on all IMC products



Condiment Prep Station

With integrated dishwasher safe cutting board, this unit is ideal for the preparation of all types of fruit and garnishes.

MODEL	PRICE £	PRICE €	WIDTH
BZ74/040	£1228	€1413	400
BZ74/060	£1471	€1692	600



General Work Station

Single piece worktop incorporating an ice chest, waste unit, perforated worktop with shelves and a sink

MODEL	PRICE £	PRICE €	WIDTH
BZ71/200	£5874	€6756	2000



Bridging Station

Single piece worktop design incorporating a perforated worktop with shelves, bridging section and shelf

MODEL	PRICE £	PRICE €	WIDTH
BZ72/200	£3421	€3935	2000



Coffee Prep Station

Worktop with under mounted knock out drawer and base shelf

MODEL	PRICE £	PRICE €	WIDTH
BZ40/040	£1581	€1819	400

Bartender

Sinks

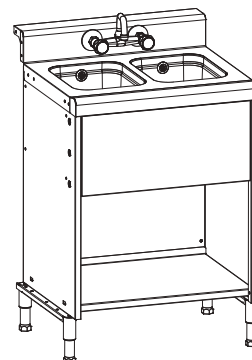
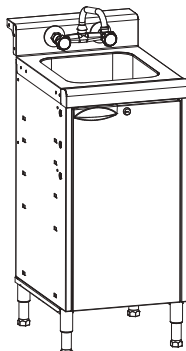
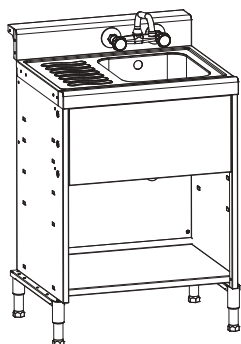

Single Sink			
MODEL	PRICE £	PRICE €	WIDTH
BZ51/030	£1200	€1380	300
BZ51/040	£1200	€1380	400
BZ51/060	£1252	€1440	600
BZ51/080	£1295	€1490	800
BZ51/100	£1346	€1548	1000

Single Sink with door option			
MODEL	PRICE £	PRICE €	WIDTH
BZ55/040	£1275	€1467	400
BZ55/060	£1346	€1548	600

Double Sink			
MODEL	PRICE £	PRICE €	WIDTH
BZ52/060	£1422	€1636	600
BZ52/080	£1464	€1684	800
BZ52/100	£1512	€1739	1000

BZ51/040 has no drainer, other sizes have left hand drainer. All have mixer tap and 1 1/4" waste trap. Optional door. Soap dispense also available

BZ52/060, BZ52/080 have no drainer. BZ52/100 has left hand drainer. One mixer tap set and a 1 1/4" waste trap supplied.

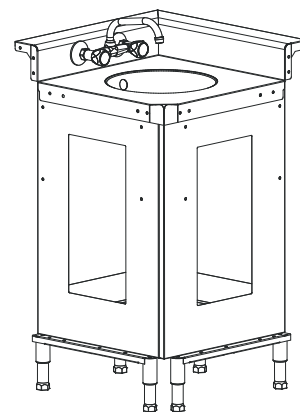
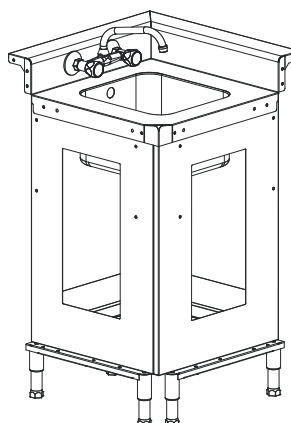
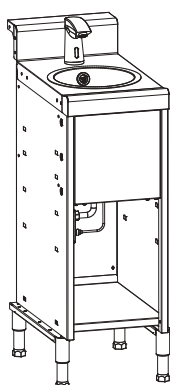
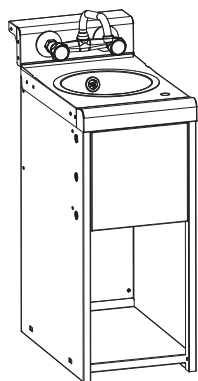

Hand wash unit with mixer tap			
MODEL	PRICE £	PRICE €	WIDTH
BZ50/031	£1200	€1380	300
BZ50/041	£1245	€1432	400

Hand wash unit with sensor tap			
MODEL	PRICE £	PRICE €	WIDTH
BZ50/032	£1720	€1978	300
BZ50/042	£1771	€2037	400

Freestanding corner - square sink		
MODEL	PRICE £	PRICE €
BZ09/037	£944	€1086

Corner - hand wash basin		
MODEL	PRICE £	PRICE €
BZ09/038	£1133	€1303

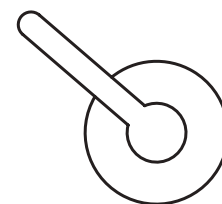
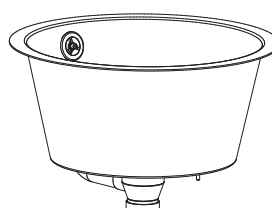
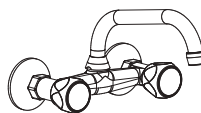
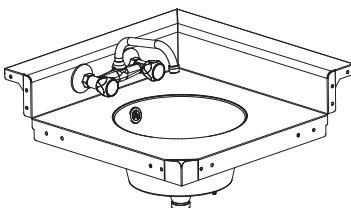
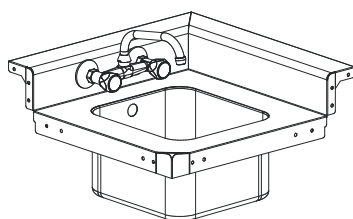

Corner - square sink		
MODEL	PRICE £	PRICE €
BZ09/036	£868	€999

Corner top - hand wash basin				
MODEL	PRICE £	PRICE €	WIDTH	DEPTH
BZ17/051	£868	€999	560	560

As BZ17/050 but fitted with BB63/001 wash hand basin. Soap dispense also available

Hand wash basin			
MODEL	PRICE £	PRICE €	WIDTH
BB63/001	£393	€452	305

Can be inset into worktops, plain bridges or custom made infills. Supplied with mixer tap set and 1 1/4" waste trap.

Soap Dispenser		
MODEL	PRICE £	PRICE €
BB64/001	£65	€75

Pre-fitted on request For inserting into hand wash unit.

Glass Refresher, Washing

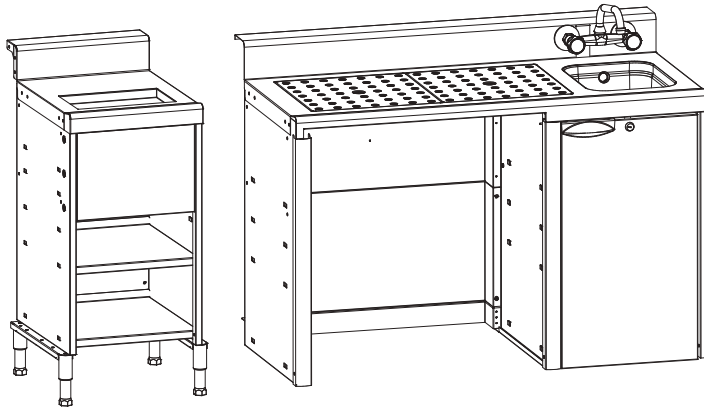

Glass Refresh Station

MODEL	PRICE £	PRICE €	WIDTH
BZ50/043	£1108	€1275	400

Glass Washer Station

MODEL	PRICE £	PRICE €	WIDTH
BZ63/110	£1768	€2034	1100

Basket Racks

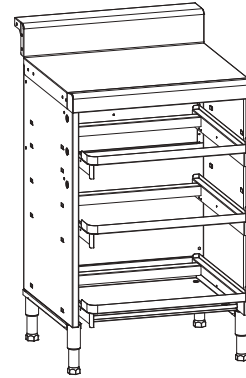

Basket Rack with telescopic slides

MODEL	PRICE £	PRICE €	WIDTH
BZ23/045	£1288	€1482	For 400mm wide baskets
BZ23/050	£1288	€1482	For 450mm wide baskets
BZ23/055	£1288	€1482	For 500mm wide baskets

Holds three 400, 450 or 500mm wide glasswasher baskets.

Waste Units

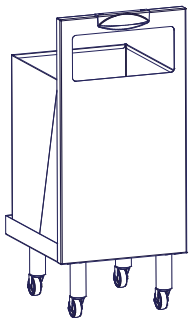

Bottle Bin with trolley and bin

MODEL	PRICE £	PRICE €	WIDTH
BB01/040	£388	€447	400
BB01/060	£412	€474	600

Wheeled bottle skip, with stainless steel front panel.

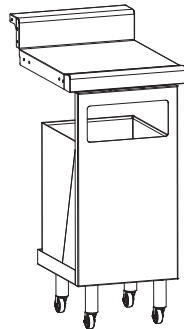

Bottle Bin with trolley, bin and plain bridge

MODEL	PRICE £	PRICE €	WIDTH
BZ35/040	£819	€942	400
BZ35/060	£868	€999	600

Wheeled bottle skip, with stainless steel front panel.

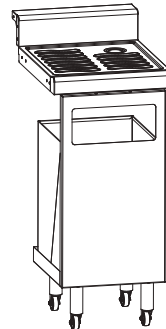

Bottle Bin with trolley, bin and drainer bridge

MODEL	PRICE £	PRICE €	WIDTH
BZ36/040	£903	€1039	400
BZ36/060	£950	€1093	600

Wheeled bottle skip, with stainless steel front panel.

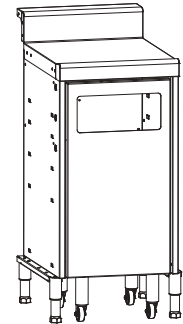

Waste Unit

MODEL	PRICE £	PRICE €	WIDTH
BZ60/040	£1028	€1183	400

Wheeled waste unit supplied with bin.

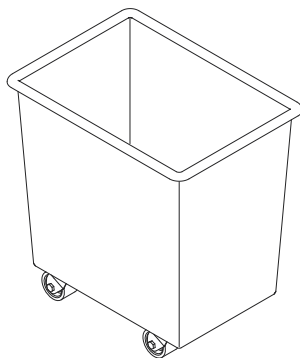

Bottle Skips

MODEL	PRICE £	PRICE €	H	W	D
BC13/001	£231	€266	695	460	650
BC13/002	£233	€268	510	460	460
BC13/003	£246	€283	620	670	615

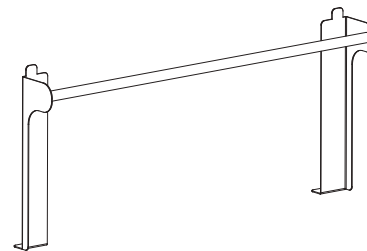

Towel Rail

MODEL	PRICE £	PRICE €	WIDTH
BB50/040	£94	€109	400
BB50/060	£102	€118	600
BB50/080	£111	€128	800
BB50/100	£116	€134	1000

Used on sinks, hand wash units, corner units, worktops and ice chests.

Bartender

Corner Shelf

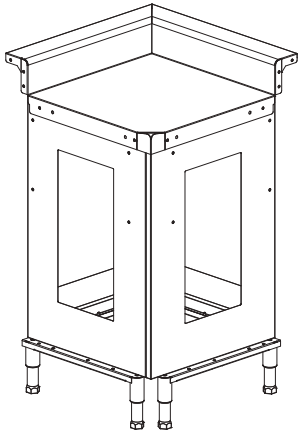

Freestanding corner - plain top		
MODEL	PRICE £	PRICE €
BZ09/039	£983	€1131

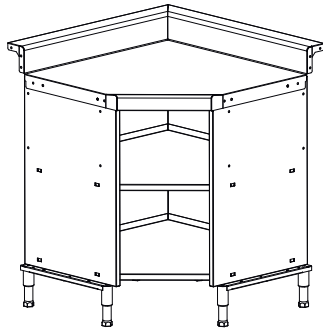

Corner unit		
MODEL	PRICE £	PRICE €
BZ80/080	£1966	€2261

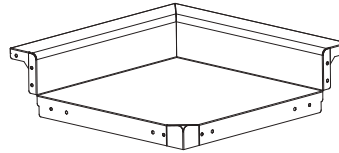

Corner Top - 90 angle splash back				
MODEL	PRICE £	PRICE €	WIDTH	DEPTH
BZ17/050	£482	€555	560	560

To link two runs of Bartender at the worktop level.

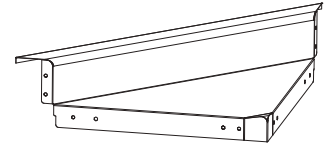

Corner Top - 45 angle splash back				
MODEL	PRICE £	PRICE €	WIDTH	DEPTH
BZ17/052	£445	€512	560	560

To link two runs of Bartender at the worktop level.

Drawer Units

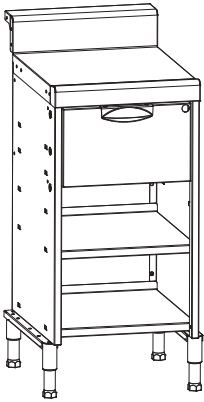

Single Drawer Unit			
MODEL	PRICE £	PRICE €	WIDTH
BZ66/040	£1275	€1467	400
BZ66/060	£1307	€1504	600

All drawers lockable individually.

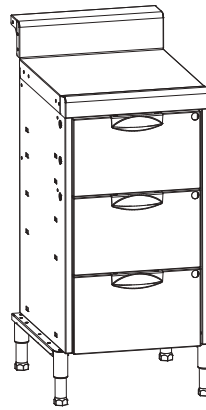

Three Drawer Unit			
MODEL	PRICE £	PRICE €	WIDTH
BZ64/040	£1581	€1819	400
BZ64/060	£1663	€1913	600

All drawers lockable individually.

Till Units

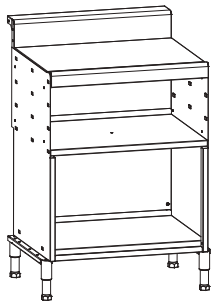

Till Unit - adjustable height			
MODEL	PRICE £	PRICE €	WIDTH
BZ67/060	£1004	€1155	600

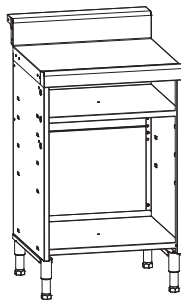

Till Unit			
MODEL	PRICE £	PRICE €	WIDTH
BZ67/055	£1004	€1155	520

Storage Cupboards

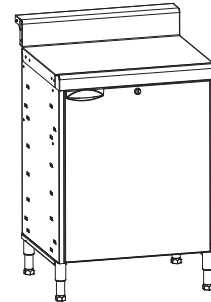

Storage Cupboard			
MODEL	PRICE £	PRICE €	WIDTH
BZ61/040	£1263	€1453	400
BZ61/060	£1346	€1548	600
BZ61/080	£1430	€1645	800
BZ61/100	£1512	€1739	1000

One or two door lockable cupboard with three internal shelves and worktop.

Blender Stations

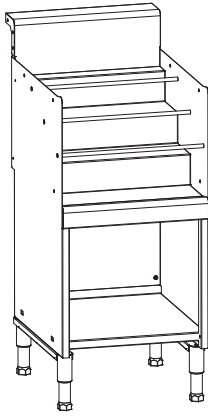

Tiered Spirit Rack			
MODEL	PRICE £	PRICE €	WIDTH
BZ75/040	£1064	€1224	400
BZ75/060	£1176	€1353	600
BZ75/080	£1320	€1518	800

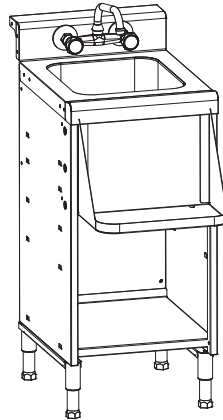

Blender Station			
MODEL	PRICE £	PRICE €	WIDTH
BZ62/040	£1389	€1598	400

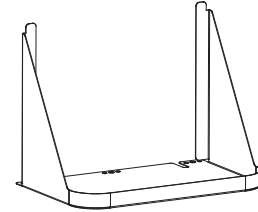

Blender Shelf				
MODEL	PRICE £	PRICE €	WIDTH	DEPTH
BB51/040	£182	€210	400	210
BB51/060	£195	€225	600	210
BB51/043	£182	€210	400	230
BB51/063	£195	€225	600	230

Use on sinks, ice chest, corner units or worktops

Ice Chests

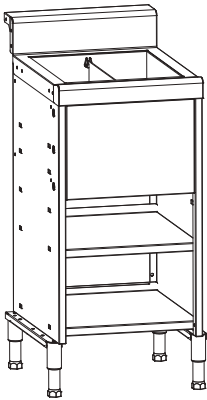

Ice Chest			
MODEL	PRICE £	PRICE €	WIDTH
BZ53/040	£1383	€1591	400
BZ53/060	£1528	€1758	600
BZ53/080	£1710	€1967	800
BZ53/100	£1891	€2175	1000

Supplied complete with removable dividers, drain trays and 1 1/4 waste trap

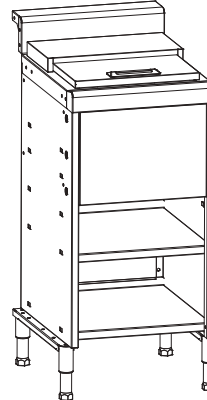

Ice Chest with covers			
MODEL	PRICE £	PRICE €	WIDTH
BZ54/040	£1566	€1801	400
BZ54/060	£1733	€1993	600
BZ54/080	£1891	€2175	800
BZ54/100	£2094	€2409	1000

As with BZ53, but with two piece sliding covers

Speed Rails

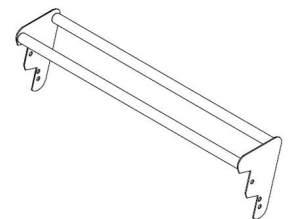
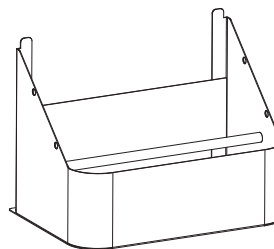
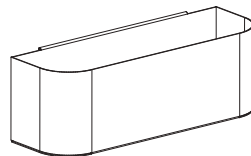
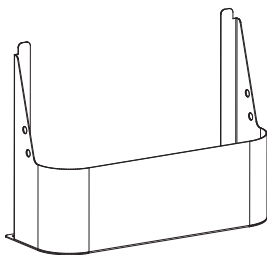

Speed Rail			
MODEL	PRICE £	PRICE €	WIDTH
BB52/040	£190	€219	400
BB52/060	£204	€235	600
BB52/080	£215	€248	800
BB52/100	£225	€259	1000

Used on ice chests, sinks and worktop

Add-on Speed Rail			
MODEL	PRICE £	PRICE €	WIDTH
BB57/040	£213	€245	400
BB57/060	£224	€258	600
BB57/080	£236	€272	800
BB57/100	£249	€287	1000

Attached to front of BB52 to double capacity.

Double Speed Rail			
MODEL	PRICE £	PRICE €	WIDTH
BB69/040	£391	€450	400
BB69/060	£418	€481	600
BB69/080	£441	€508	800
BB69/100	£462	€532	1000

Speed Rail Lock			
MODEL	PRICE £	PRICE €	WIDTH
BB68/040	£93	€107	400
BB68/060	£99	€114	600
BB68/080	£106	€122	800
BB68/100	£116	€134	1000

Used on single and double speed rails

Bartender

Trims and Décor



Single Trim		
MODEL	PRICE £	PRICE €
BB71/001	£26	€30

To be attached to the end unit in a run of Bartender



Double Trim		
MODEL	PRICE £	PRICE €
BB71/002	£39	€45

To join two adjacent Bartender units in a straight run



Corner Trim		
MODEL	PRICE £	PRICE €
BB71/003	£62	€72

To join two adjacent Bartender units at an angle.



Décor Panel		
MODEL	PRICE £	PRICE €
BB56/001	£91	€106

Polished stainless steel decor panels provide a clean finish at the end of a run.

Bar Supports

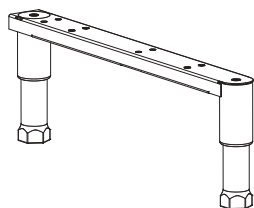

Leg Frame			
MODEL	PRICE £	PRICE €	HEIGHT
BB02/208	£73	€84	150mm high
BB02/308	£74	€86	200mm high

Units are supplied with one leg frame only, as adjacent units share one frame between them. Extra frames may be required:

- at the end of each straight run of Bartender
- where a bridge is introduced into a run

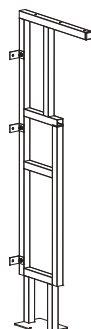

Stainless Steel Bar Support			
MODEL	PRICE £	PRICE €	HEIGHT
BB70/001/SS	£306	€352	1060mm high
BB70/002/SS	£444	€511	1060mm high



Single Pole Leg			
MODEL	PRICE £	PRICE €	HEIGHT
BB02/211	£85	€98	adjustable
BB02/212	£73	€84	100
BB02/213	£73	€84	150

Supports infill or bridging section at end of run

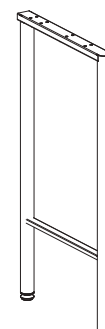

Double Pole Leg		
MODEL	PRICE £	PRICE €
BB02/210	£135	€156

Supports infill or bridging section at end of run

End Panel



Left Hand Panel		
MODEL	PRICE £	PRICE €
BB56/003	£118	€136

To be attached to the end unit in a run of Bartender



Right Hand Panel		
MODEL	PRICE £	PRICE €
BB56/004	£120	€138

To be attached to the end unit in a run of Bartender

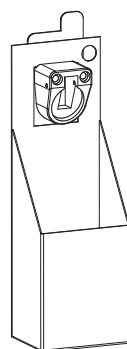

Bottle Opener		
MODEL	PRICE £	PRICE €
BB55/001	£83	€96

Can be fitted to ice chests, sinks or worktops. Includes catcher

Accessories

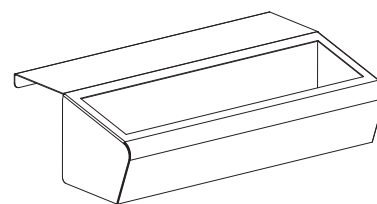

Condiment Set				
MODEL	PRICE £	PRICE €	WIDTH	WIDTH
BB53/035	£195	€225	2 x 1/9 x 65mm GN containers	350
BB53/052	£221	€255	3 x 1/9 x 65mm GN containers	525

Hangs on splashback

Worktops

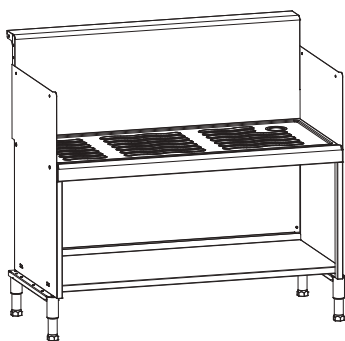

Beer Station			
MODEL	PRICE £	PRICE €	WIDTH
BZ34/040	£1389	€1598	400
BZ34/060	£1431	€1646	600
BZ34/080	£1480	€1702	800
BZ34/100	£1518	€1746	1000

Drainer is 800mm above floor, to accommodate low level beer pumps. Supplied with 1 1/4" waste trap.

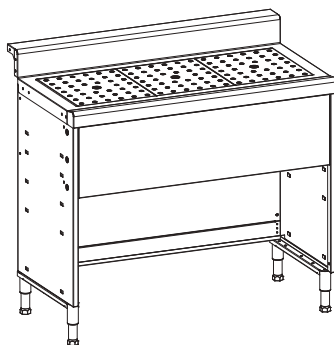

Perforated Worktop - reinforced top			
MODEL	PRICE £	PRICE €	WIDTH
BZ69/040/BF	£1380	€1587	400
BZ69/060/BF	£1464	€1684	600
BZ69/080/BF	£1544	€1776	800
BZ69/100/BF	£1628	€1873	1000

For mounting of beer fonts

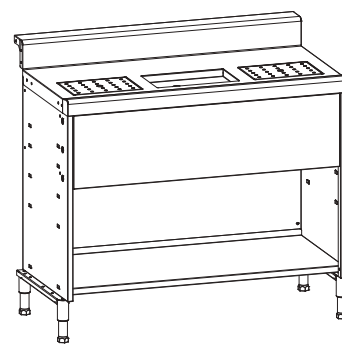

Perforated Worktop			
MODEL	PRICE £	PRICE €	WIDTH
BZ69/040	£1263	€1453	400
BZ69/060	£1346	€1548	600
BZ69/080	£1430	€1645	800
BZ69/100	£1512	€1739	1000

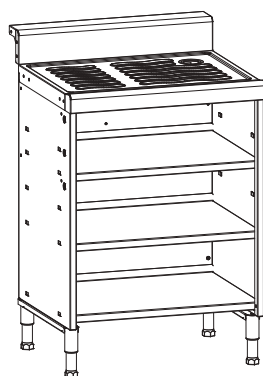

Shelf Drainer - stainless steel shelves			
MODEL	PRICE £	PRICE €	WIDTH
BZ25/040	£1200	€1380	400
BZ25/060	£1263	€1453	600
BZ25/080	£1320	€1518	800
BZ25/100	£1380	€1587	1000

As BZ15, but with a pressed drainer top. Supplied with 1 1/4" waste trap

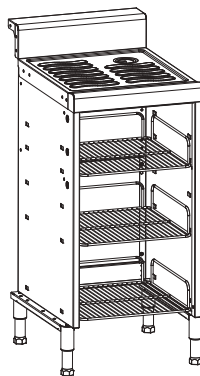

Shelf Drainer - wire shelves			
MODEL	PRICE £	PRICE €	WIDTH
BZ38/040	£1200	€1380	400
BZ38/060	£1263	€1453	600
BZ38/080	£1320	€1518	800
BZ38/100	£1380	€1587	1000

As BZ37, but with a pressed drainer top. Supplied with 1 1/4" waste trap

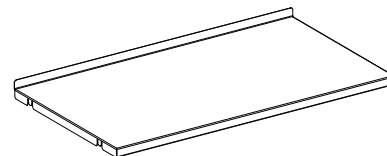

Plain Shelves			
MODEL	PRICE £	PRICE €	WIDTH
BB72/040	£114	€132	400
BB72/060	£136	€157	600
BB72/080	£159	€183	800
BB72/100	£182	€210	1000

As BZ37, but with a pressed drainer top. Supplied with 1 1/4" waste trap

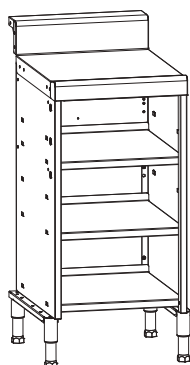

Shelf Unit - stainless steel shelves			
MODEL	PRICE £	PRICE €	WIDTH
BZ15/030	£1105	€1271	300
BZ15/040	£1117	€1285	400
BZ15/050	£1152	€1325	500
BZ15/060	£1177	€1354	600
BZ15/080	£1233	€1418	800
BZ15/100	£1295	€1490	1000

Capacity of up to 200 pint (60cl) glasses per metre.

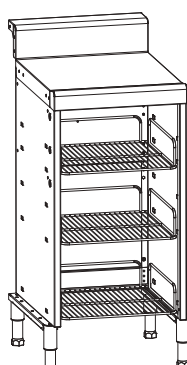

Shelf Unit - wire shelves			
MODEL	PRICE £	PRICE €	WIDTH
BZ37/040	£1117	€1285	400
BZ37/050	£1152	€1325	500
BZ37/060	£1177	€1354	600
BZ37/080	£1233	€1418	800
BZ37/100	£1295	€1490	1000

Capacity of up to 200 pint (60cl) glasses per metre.

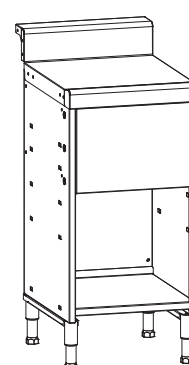

Worktop Unit			
MODEL	PRICE £	PRICE €	WIDTH
BZ50/040	£847	€975	400
BZ50/060	£896	€1031	600
BZ50/080	£941	€1083	800
BZ50/100	£990	€1139	1000

Use instead of BZ15 shelf unit where speed rail, bartender shelf or towel rail is required

Bartender

Bridges and Infills

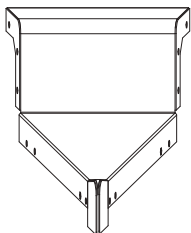

Single Splashback Internal Corner

MODEL	PRICE £	PRICE €	DEGREES
BB17/005 S	£444	€511	5
BB17/010 S	£444	€511	10
BB17/020 S	£458	€527	20
BB17/030 S	£488	€562	30
BB17/040 S	£514	€592	40
BB17/050 S	£542	€624	50
BB17/060 S	£568	€654	60
BB17/070 S	£597	€687	70
BB17/080 S	£624	€718	80

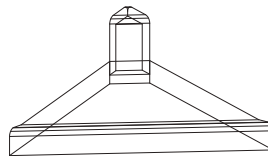

Single Splashback External Corner

MODEL	PRICE £	PRICE €	DEGREES
BB18/010 S	£404	€465	10
BB18/020 S	£431	€496	20
BB18/030 S	£458	€527	30
BB18/040 S	£488	€562	40
BB18/050 S	£514	€592	50
BB18/060 S	£542	€624	60
BB18/070 S	£568	€654	70
BB18/080 S	£597	€687	80

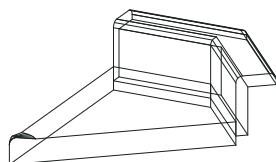

Double Splashback Internal Corner

MODEL	PRICE £	PRICE €	DEGREES
BB17/030 D	£627	€722	30
BB17/040 D	£677	€799	40
BB17/050 D	£726	€835	50
BB17/060 D	£777	€894	60
BB17/070 D	£827	€952	70
BB17/080 D	£876	€1008	80

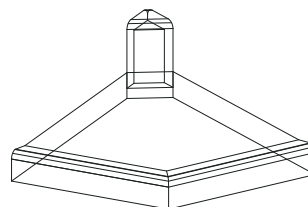

Double Splashback External Corner

MODEL	PRICE £	PRICE €	DEGREES
BB18/030 D	£578	€665	30
BB18/040 D	£677	€779	40
BB18/050 D	£726	€835	50
BB18/060 D	£777	€894	60
BB18/070 D	£827	€952	70
BB18/080 D	£876	€1008	80

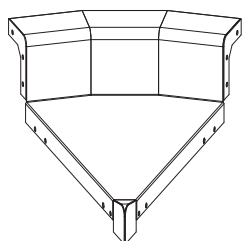

Triple Splashback Internal Corner

MODEL	PRICE £	PRICE €	DEGREES
BB17/050 T	£863	€993	50
BB17/060 T	£910	€1047	60
BB17/070 T	£956	€1100	70
BB17/080 T	£1035	€1191	80
BB17/090 T	£1083	€1246	90

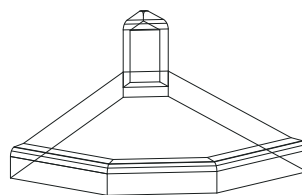

Triple Splashback External Corner

MODEL	PRICE £	PRICE €	DEGREES
BB18/050 T	£863	€993	50
BB18/060 T	£910	€1047	60
BB18/070 T	£956	€1100	70
BB18/080 T	£1004	€1155	80

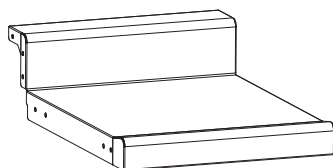

Plain Bridge

MODEL	PRICE £	PRICE €	WIDTH
BZ09/010	£394	€454	100
BZ09/020	£394	€454	200
BZ09/030	£405	€466	300
BZ09/040	£431	€496	400
BZ09/050	£458	€527	500
BZ09/060	£458	€527	600
BZ09/070	£469	€540	700
BZ09/080	£482	€555	800
BZ09/090	£493	€567	900
BZ09/100	£504	€580	1000

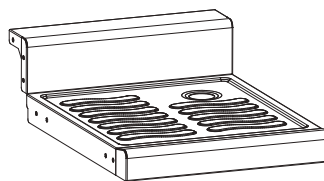

Drainer Bridge

MODEL	PRICE £	PRICE €	WIDTH
BZ08/040	£517	€595	400
BZ08/060	£541	€623	600
BZ08/080	£564	€649	800
BZ08/100	£587	€676	1000

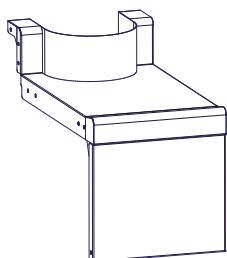

Python Bridge

MODEL	PRICE £	PRICE €	WIDTH
BZ73/030	£441	€508	300

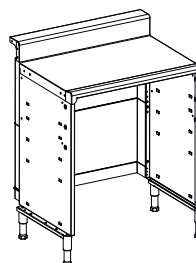

Worktop for V60

MODEL	PRICE £	PRICE €	WIDTH
BZ15/101	£941	€1083	700

Worktop for V90

MODEL	PRICE £	PRICE €	WIDTH
BZ15/102	£990	€1139	1000

Ventus



With a wide range of options available, Ventus bottle coolers and glass frosters can be tailored to suit any bar environment.

Showcase drinks elegantly, while ensuring they are kept at the optimum serving temperature. We offer a wide variety of bottle coolers and glass frosters, with over 150 options to choose from, to ensure we have a design that complements every bar setting.

Each model has a Dynamic Air Distribution System, and EcoSmart controller, ensuring the most economical running. With a variety of space-saving sizes available, we're sure to have a solution perfect for any available space.

Ideally suited for...



Bars

Keep drinks at the perfect serving temperature to speed up service and generate customer satisfaction with ice cold drinks.



Clubs

Serve ice cold drinks with visual appeal with Ventus. With easy access, large storage capacities and rapid chill, keep the drinks flowing through your busiest periods.



Hotels

Attract customers in your hotel's bar with an elegant bottle cooler or glass froster. Show your drinks in their best light in a well-designed unit that enhances your offer.



Cafes and coffee shops

Encourage customers to spend by tempting them with well-presented drinks. Showcase your offer and ensure great-tasting beverages with a Ventus unit.

With over 150 options available, tailor your Ventus bottle cooler to fit any setting.

Benefits at a glance

- Over 150 options to choose from
- Energy efficient EcoSmart controller
- Quick and easy access
- Variety of sizes to suit the space you have available
- Choice of exterior colours

Ventus Options

Ventus bottle coolers and glass frosters can be tailored to suit any bar environment.

Ventus V60							Ventus V90							Ventus V135			
V60 Standard - 900mm High	V60 Reduced Height - 850mm High	V60 Reduced Height - 800mm High	V60 Reduced Depth - 450mm Deep	V60 Full Front - 900mm High	V60 Full Front Reduced Height - 850mm High	V60 Full Front Reduced Height - 800mm High	V90 Standard - 900mm High	V90 Reduced Height - 850mm High	V90 Reduced Height - 800mm High	V90 Reduced Depth - 450mm Deep	V90 Full Front - 900mm High	V90 Full Front Reduced Height - 850mm High	V90 Full Front Reduced Height - 800mm High	V135 Standard - 900mm High	V135 Reduced Height - 800mm High	V135 Full Front - 900mm High	V135 Full Front Reduced Height - 800mm High

COLOUR

STAINLESS STEEL	•	•	•	•	•	•	•	•	•	•	•	•	•	•	•	•	•
BLACK	•	•	•	•	•	•	•	•	•	•	•	•	•	•	•	•	•

PLUG

UK 3 PIN PLUG	•	•	•	•	•	•	•	•	•	•	•	•	•	•	•	•	•
EU 2 PIN PLUG	○	○	○	○	○	○	○	○	○	○	○	○	○	○	○	○	○

DOOR TYPE

GLASS DOOR (STANDARD HANDLE ONLY)	•	•	•	•	•	•	•	•	•	•	•	•	•	•	•	•	•	
SOLID DOOR (STANDARD HANDLE ONLY)	○	○	○	○	○	○	○	○	○	○	○	○	○	○	○	○	○	
WOODEN CLADDED DOOR FRAME	N/A	N/A	N/A	N/A	○	○	○	N/A	N/A	N/A	N/A	○	○	○	N/A	N/A	○	○

DOOR HINGING

RIGHT HINGED	•	•	•	•	•	•	•	N/A	N/A	N/A	N/A	N/A	N/A	N/A	N/A	N/A	N/A	N/A
LEFT HINGED	○	○	○	○	○	○	○	N/A	N/A	N/A	N/A	N/A	N/A	N/A	N/A	N/A	N/A	N/A

HANDLE TYPE

STANDARD HANDLE	•	•	•	•	•	•	•	•	•	•	•	•	•	•	•	•	•	•
-----------------	---	---	---	---	---	---	---	---	---	---	---	---	---	---	---	---	---	---

SHELVING

CHROME WIRE SHELVING	•	•	•	•	•	•	•	•	•	•	•	•	•	•	•	•	•	•
PERFORATED SHELVING	○	○	○	○	○	○	○	○	○	○	○	○	○	○	○	○	○	○
WINE SHELVING	○	○	○	N/A	○	○	○	○	○	○	N/A	○	○	○	○	○	○	○

- Fitted as standard
- Available as an option
- N/A Not available for this model

Ventus Options

With over 150 options available, tailor your Ventus bottle cooler or glass froster to your requirements.

Door Styles



Standard



Solid

Shelving Type



Standard chrome wire



Chrome wine shelf



Perforated shelf

Ventus V60

Ventus V60 Standard - 900mm High

- Wide range of options available to customise your bottle cooler, ensure a perfect fit in any bar
- Elegant, flexible storage for up to 120 bottles
- Dynamic Air Distribution System coupled with efficient compressors and improved insulation ensures superior cooling times
- Electronic temperature control keeps drinks at the perfect serving temperature
- Energy efficient EcoSmart controller - at the touch of a button, put the bottle cooler into its most economical state until next required
- Sleek stainless steel interior and LED lighting to enhance display
- Single double-glazed lockable door for enhanced security
- UK 3 pin plug allows users to simply plug in and switch on



Ventus V60 Standard - 900mm High											
MODEL	PRICE £	PRICE €	DESCRIPTION	DOOR HINGING	H	W	D	POWER	GAS TYPE	CAPACITY	WT
F76/150	£2009	€2311	Glass Door Stainless Steel	Right	900	600	500	393W	R290	120 Bottles	65
F76/150/B	£2009	€2311	Glass Door Black Painted	Right	900	600	500	393W	R290	120 Bottles	65

V60 Standard 900mm High Factory Fit Options

MODEL	PRICE £	PRICE €	DESCRIPTION	
Door Type				
0*	VS430	£36	€42	Solid Door - Stainless Steel - Change from Standard Glass to Solid Door
0*	VS432	£36	€42	Solid Door - Black Painted - Change from Standard Glass to Solid Door
0*	VS406	£31	€36	Left Hinged Glass Door - Stainless Steel - Change from Standard Glass to Left Hinged Glass Door
0*	VS507	£31	€36	Left Hinged Glass Door - Black Painted - Change from Standard Glass to Left Hinged Glass Door
0*	VS454	£31	€36	Left Hinged Solid Door - Stainless Steel - Change from Standard Solid to Left Hinged Solid Door
0*	VS455	£31	€36	Left Hinged Solid Door - Black Painted - Change from Standard Solid to Left Hinged Solid Door
Shelving Type				
0*	VS399	£157	€181	Perforated Shelving - Change from Standard Wire Shelves to Perforated Shelves
0*	VS359	£39	€45	Wine Shelving - Change from Standard Wire Shelves to Wine Shelves
Plug Type				
0*	VS401	£0	€0	EU 2-Pin Plug - Change from UK to EU Plug
De-gassed				
0*	VS1017	£103	€119	De-gassed Unit (Only Required to Make Suitable for Air Freight)

0* Factory fitted option please request at point of ordering

Accessories

MODEL	PRICE £	PRICE €	DESCRIPTION	
A	A12/100	£126.70	€145.75	Chrome Wine Shelf
A	A12/091/Z1	£63.35	€72.90	Chrome Wire Shelf
A	S76/048	£39	€45	Perforated Shelf

Ventus V60 Reduced Height - 850mm High

- Reduced 850mm height
- Wide range of options available to customise your bottle cooler, ensure a perfect fit in any bar
- Elegant, flexible storage for up to 78 bottles
- Dynamic Air Distribution System coupled with efficient compressors and improved insulation ensures superior cooling times
- Electronic temperature control keeps drinks at the perfect serving temperature
- Energy efficient EcoSmart controller - at the touch of a button, put the bottle cooler into its most economical state until next required
- Sleek stainless steel interior and LED lighting to enhance display
- Single double-glazed lockable door for enhanced security
- UK 3 pin plug allows users to simply plug in and switch on



Ventus V60 Reduced Height - 850mm High											
MODEL	PRICE £	PRICE €	DESCRIPTION	DOOR HINGING	H	W	D	POWER	GAS TYPE	CAPACITY	WT
F76/151	£2009	€2311	Glass Door Stainless Steel	Right	850	600	500	393W	R290	78 Bottles	64
F76/151/B	£2009	€2311	Glass Door Black Painted	Right	850	600	500	393W	R290	78 Bottles	64

V60 Standard 850mm High Factory Fit Options

MODEL	PRICE £	PRICE €	DESCRIPTION	
Door Type				
0*	VS431	£36	€42	Solid Door - Stainless Steel - Change from Standard Glass to Solid Door
0*	VS433	£36	€42	Solid Door - Black Painted - Change from Standard Glass to Solid Door
0*	VS407	£31	€36	Left Hinged Glass Door - Stainless Steel - Change from Standard Glass to Left Hinged Glass Door
0*	VS508	£31	€36	Left Hinged Glass Door - Black Painted - Change from Standard Glass to Left Hinged Glass Door
0*	VS545	£31	€36	Left Hinged Solid Door - Stainless Steel - Change from Standard Solid to Left Hinged Solid Door
0*	VS627	£31	€36	Left Hinged Solid Door - Black Painted - Change from Standard Solid to Left Hinged Solid Door
Shelving Type				
0*	VS399	£157	€181	Perforated Shelving - Change from Standard Wire Shelves to Perforated Shelves
0*	VS359	£39	€45	Wine Shelving - Change from Standard Wire Shelves to Wine Shelves
Plug Type				
0*	VS401	£0	€0	EU 2-Pin Plug - Change from UK to EU Plug
De-gassed				
0*	VS1017	£103	€119	De-gassed Unit (Only Required to Make Suitable for Air Freighting)

0* Factory fitted option please request at point of ordering

Accessories

MODEL	PRICE £	PRICE €	DESCRIPTION	
A	A12/100	£126.70	€145.75	Chrome Wine Shelf
A	A12/091/Z1	£63.35	€72.90	Chrome Wire Shelf
A	S76/048	£39	€45	Perforated Shelf

Ventus V60

Ventus V60 Reduced Height - 800mm High

- Reduced 800mm height
- Wide range of options available to customise your bottle cooler, ensure a perfect fit in any bar
- Elegant, flexible storage for up to 78 bottles
- Dynamic Air Distribution System coupled with efficient compressors and improved insulation ensures superior cooling times
- Electronic temperature control keeps drinks at the perfect serving temperature
- Energy efficient EcoSmart controller - at the touch of a button, put the bottle cooler into its most economical state until next required
- Sleek stainless steel interior and LED lighting to enhance display
- Single double-glazed lockable door for enhanced security
- UK 3 pin plug allows users to simply plug in and switch on



Ventus V60 Reduced Height - 800mm High											
MODEL	PRICE £	PRICE €	DESCRIPTION	DOOR HINGING	H	W	D	POWER	GAS TYPE	CAPACITY	WT
F76/152	£2009	€2311	Glass Door Stainless Steel	Right	800	600	500	393W	R290	78 Bottles	62
F76/152/B	£2009	€2311	Glass Door Black Painted	Right	800	600	500	393W	R290	78 Bottles	62

V60 Standard 800mm High Factory Fit Options

MODEL	PRICE £	PRICE €	DESCRIPTION
Door Type			
0* VS409	£36	€42	Solid Door - Stainless Steel - Change from Standard Glass to Solid Door
0* VS414	£36	€42	Solid Door - Black Painted - Change from Standard Glass to Solid Door
0* VS408	£31	€36	Left Hinged Glass Door - Stainless Steel - Change from Standard Glass to Left Hinged Glass Door
0* VS509	£200	€230	Left Hinged Glass Door - Black Painted - Change from Standard Glass to Left Hinged Glass Door
0* VS618	£31	€36	Left Hinged Solid Door - Stainless Steel - Change from Standard Solid to Left Hinged Solid Door
0* VS652	£31	€36	Left Hinged Solid Door - Black Painted - Change from Standard Solid to Left Hinged Solid Door
Shelving Type			
0* VS399	£157	€181	Perforated Shelving - Change from Standard Wire Shelves to Perforated Shelves
0* VS359	£39	€45	Wine Shelving - Change from Standard Wire Shelves to Wine Shelves
Plug Type			
0* VS401	£0	€0	EU 2-Pin Plug - Change from UK to EU Plug
De-gassed			
0* VS1017	£103	€119	De-gassed Unit (Only Required to Make Suitable for Air Freighting)

0* Factory fitted option please request at point of ordering

Accessories

MODEL	PRICE £	PRICE €	DESCRIPTION
A A12/100	£126.70	€145.75	Chrome Wine Shelf
A A12/091/Z1	£63.35	€72.90	Chrome Wire Shelf
A S76/048	£39	€45	Perforated Shelf

Ventus V60 Reduced Depth - 450mm Deep

- Reduced 450mm depth
- Wide range of options available to customise your bottle cooler, ensure a perfect fit in any bar
- Elegant, flexible storage for up to 96 bottles
- Dynamic Air Distribution System coupled with efficient compressors and improved insulation ensures superior cooling times
- Electronic temperature control keeps drinks at the perfect serving temperature
- Energy efficient EcoSmart controller - at the touch of a button, put the bottle cooler into its most economical state until next required
- Sleek stainless steel interior and LED lighting to enhance display
- Single double-glazed lockable door for enhanced security
- UK 3 pin plug allows users to simply plug in and switch on



Ventus V60 Reduced Depth - 450mm Deep											
MODEL	PRICE £	PRICE €	DESCRIPTION	DOOR HINGING	H	W	D	POWER	GAS TYPE	CAPACITY	WT
F76/153	£2009	€2311	Glass Door Stainless Steel	Right	900	600	450	393W	R290	96 Bottles	64
F76/153/B	£2009	€2311	Glass Door Black Painted	Right	900	600	450	393W	R290	96 Bottles	64

V60 Standard 850mm High Factory Fit Options

MODEL	PRICE £	PRICE €	DESCRIPTION
Door Type			
0* VS430	£36	€42	Solid Door - Stainless Steel - Change from Standard Glass to Solid Door
0* VS432	£36	€42	Solid Door - Black Painted - Change from Standard Glass to Solid Door
0* VS406	£31	€36	Left Hinged Glass Door - Stainless Steel - Change from Standard Glass to Left Hinged Glass Door
0* VS507	£31	€36	Left Hinged Glass Door - Black Painted - Change from Standard Glass to Left Hinged Glass Door
0* VS454	£31	€36	Left Hinged Solid Door - Stainless Steel - Change from Standard Solid to Left Hinged Solid Door
0* VS455	£31	€36	Left Hinged Solid Door - Black Painted - Change from Standard Solid to Left Hinged Solid Door
Shelving Type			
0* VS402	£157	€181	Perforated Shelving - Change from Standard Wire Shelves to Perforated Shelves
Plug Type			
0* VS401	£0	€0	EU 2-Pin Plug - Change from UK to EU Plug
De-gassed			
0* VS1017	£103	€119	De-gassed Unit (Only Required to Make Suitable for Air Freightling)

0* Factory fitted option please request at point of ordering

Accessories

MODEL	PRICE £	PRICE €	DESCRIPTION
A S76/123	£39	€45	Perforated Shelf

Ventus V60

Ventus V60 Full Front - 900mm High

- Full front door for seamless integration
- Wide range of options available to customise your bottle cooler, ensure a perfect fit in any bar
- Elegant, flexible storage for up to 120 bottles
- Dynamic Air Distribution System coupled with efficient compressors and improved insulation ensures superior cooling times
- Electronic temperature control keeps drinks at the perfect serving temperature
- Energy efficient EcoSmart controller - at the touch of a button, put the bottle cooler into its most economical state until next required
- Sleek stainless steel interior and LED lighting to enhance display
- Double-glazed door for enhanced insulation
- UK 3 pin plug allows users to simply plug in and switch on



Ventus V60 Full Front - 900mm High											
MODEL	PRICE £	PRICE €	DESCRIPTION	DOOR HINGING	H	W	D	POWER	GAS TYPE	CAPACITY	WT
F76/170	£2009	€2311	Glass Door Stainless Steel	Right	900	600	500	393W	R290	120 Bottles	65
F76/170/B	£2009	€2311	Glass Door Black Painted	Right	900	600	500	393W	R290	120 Bottles	65

V60 Full Front Glass 900mm High Factory Fit Options

MODEL	PRICE £	PRICE €	DESCRIPTION
Door Type			
0* VS726	£36	€42	Solid Door - Stainless Steel - Change from Full Front Glass to Full Front Solid Door
0* VS738	£36	€42	Solid Door - Black Painted - Change from Full Front Glass to Full Front Solid Door
0* VS709	£36	€42	Left Hinged Glass Door - Stainless Steel - Change from Right Hinged to Left Hinged Glass Door
0* VS712	£36	€42	Left Hinged Glass Door - Black Painted - Change from Right Hinged to Left Hinged Glass Door
0* VS729	£36	€42	Left Hinged Solid Door - Stainless Steel - Change from Right Hinged to Left Hinged Solid Door
0* VS741	£36	€42	Left Hinged Solid Door - Black Painted - Change from Right Hinged to Left Hinged Solid Door
0* VS1009	£27	€32	Full Front Cladded Door - Stainless Steel - Change from Glass Door to Own Cladding - Customer Supplied Wood Panel
0* VS1026	£33	€38	Full Front Cladded Door - Black Painted - Change from Glass Door to Own Cladding - Customer Supplied Wood Panel
0* VS708	£77	€89	Left Hand Hinge Kit for Full Front Cladded Doors - Add to Full Front Cladded Models to Convert to Left Hand Hinge
Shelving Type			
0* VS399	£157	€181	Perforated Shelving - Change from Standard Wire Shelves to Perforated Shelves
0* VS359	£39	€45	Wine Shelving - Change from Standard Wire Shelves to Wine Shelves
Plug Type			
0* VS401	£0	€0	EU 2-Pin Plug - Change from UK to EU Plug
De-gassed			
0* VS1017	£103	€119	De-gassed Unit (Only Required to Make Suitable for Air Freighting)

0* Factory fitted option please request at point of ordering

Accessories

MODEL	PRICE £	PRICE €	DESCRIPTION
A A12/100	£126.70	€145.75	Chrome Wine Shelf
A A12/091/Z1	£63.35	€72.90	Chrome Wire Shelf
A S76/048	£39	€45	Perforated Shelf

2 YEAR
UK parts and labour warranty
Export parts warranty
on all IMC products

Ventus V60 Full Front - 850mm High

- Full front door for seamless integration
- Reduced 850mm height
- Wide range of options available to customise your bottle cooler, ensure a perfect fit in any bar
- Elegant, flexible storage for up to 78 bottles
- Dynamic Air Distribution System coupled with efficient compressors and improved insulation ensures superior cooling times
- Electronic temperature control keeps drinks at the perfect serving temperature
- Energy efficient EcoSmart controller - at the touch of a button, put the bottle cooler into its most economical state until next required
- Sleek stainless steel interior and LED lighting to enhance display
- Double-glazed door for enhanced insulation
- UK 3 pin plug allows users to simply plug in and switch on



Ventus V60 Full Front - 850mm High											
MODEL	PRICE £	PRICE €	DESCRIPTION	DOOR HINGING	H	W	D	POWER	GAS TYPE	CAPACITY	WT
F76/171	£2009	€2311	Glass Door Stainless Steel	Right	850	600	500	393W	R290	78 Bottles	64
F76/171/B	£2009	€2311	Glass Door Black Painted	Right	850	600	500	393W	R290	78 Bottles	64

V60 Full Front Glass 850mm High Factory Fit Options

MODEL	PRICE £	PRICE €	DESCRIPTION
Door Type			
0* VS727	£36	€42	Solid Door - Stainless Steel - Change from Full Front Glass to Full Front Solid Door
0* VS739	£36	€42	Solid Door - Black Painted - Change from Full Front Glass to Full Front Solid Door
0* VS710	£36	€42	Left Hinged Glass Door - Stainless Steel - Change from Right Hinged to Left Hinged Glass Door
0* VS713	£36	€42	Left Hinged Glass Door - Black Painted - Change from Right Hinged to Left Hinged Glass Door
0* VS730	£36	€42	Left Hinged Solid Door - Stainless Steel - Change from Right Hinged to Left Hinged Solid Door
0* VS742	£36	€42	Left Hinged Solid Door - Black Painted - Change from Right Hinged to Left Hinged Solid Door
0* VS1010	£27	€32	Full Front Cladded Door - Stainless Steel - Change from Glass Door to Own Cladding - Customer Supplied Wood Panel
0* VS1027	£33	€38	Full Front Cladded Door - Black Painted - Change from Glass Door to Own Cladding - Customer Supplied Wood Panel
0* VS708	£77	€89	Left Hand Hinge Kit for Full Front Cladded Doors - Add to Full Front Cladded Models to Convert to Left Hand Hinge
Shelving Type			
0* VS399	£157	€181	Perforated Shelving - Change from Standard Wire Shelves to Perforated Shelves
0* VS359	£39	€45	Wine Shelving - Change from Standard Wire Shelves to Wine Shelves
Plug Type			
0* VS401	£0	€0	EU 2-Pin Plug - Change from UK to EU Plug
De-gassed			
0* VS1017	£103	€119	De-gassed Unit (Only Required to Make Suitable for Air Freighting)

0* Factory fitted option please request at point of ordering

Accessories

MODEL	PRICE £	PRICE €	DESCRIPTION
A A12/100	£126.70	€145.75	Chrome Wine Shelf
A A12/091/Z1	£63.35	€72.90	Chrome Wire Shelf
A S76/048	£39	€45	Perforated Shelf

2
YEAR

UK parts
and labour
warranty

Export
parts
warranty

on all IMC products

Ventus V60

Ventus V60 Full Front - 800mm High

- Full front door for seamless integration
- Reduced 800mm height
- Wide range of options available to customise your bottle cooler, ensure a perfect fit in any bar
- Elegant, flexible storage for up to 78 bottles
- Dynamic Air Distribution System coupled with efficient compressors and improved insulation ensures superior cooling times
- Electronic temperature control keeps drinks at the perfect serving temperature
- Energy efficient EcoSmart controller - at the touch of a button, put the bottle cooler into its most economical state until next required
- Sleek stainless steel interior and LED lighting to enhance display
- Double-glazed door for enhanced insulation
- UK 3 pin plug allows users to simply plug in and switch on



V60 Full Front Glass 800mm High Factory Fit Options											
MODEL	PRICE £	PRICE €	DESCRIPTION	DOOR HINGING	H	W	D	POWER	GAS TYPE	CAPACITY	WT
F76/172	£2009	€2311	Glass Door Stainless Steel	Right	800	600	500	393W	R290	78 Bottles	62
F76/172/B	£2009	€2311	Glass Door Black Painted	Right	800	600	500	393W	R290	78 Bottles	62

V60 Full Front Glass 800mm High Factory Fit Options

MODEL	PRICE £	PRICE €	DESCRIPTION
Door Type			
0* VS728	£36	€42	Solid Door - Stainless Steel - Change from Full Front Glass to Full Front Solid Door
0* VS740	£36	€42	Solid Door - Black Painted - Change from Full Front Glass to Full Front Solid Door
0* VS711	£36	€42	Left Hinged Glass Door - Stainless Steel - Change from Right Hinged to Left Hinged Glass Door
0* VS714	£36	€42	Left Hinged Glass Door - Black Painted - Change from Right Hinged to Left Hinged Glass Door
0* VS731	£36	€42	Left Hinged Solid Door - Stainless Steel - Change from Right Hinged to Left Hinged Solid Door
0* VS743	£36	€42	Left Hinged Solid Door - Black Painted - Change from Right Hinged to Left Hinged Solid Door
0* VS1011	£27	€32	Full Front Cladded Door - Stainless Steel - Change from Glass Door to Own Cladding - Customer Supplied Wood Panel
0* VS1028	£33	€38	Full Front Cladded Door - Black Painted - Change from Glass Door to Own Cladding - Customer Supplied Wood Panel
0* VS708	£77	€89	Left Hand Hinge Kit for Full Front Cladded Doors - Add to Full Front Cladded Models to Convert to Left Hand Hinge
Shelving Type			
0* VS399	£157	€181	Perforated Shelving - Change from Standard Wire Shelves to Perforated Shelves
0* VS359	£39	€45	Wine Shelving - Change from Standard Wire Shelves to Wine Shelves
Plug Type			
0* VS401	£0	€0	EU 2-Pin Plug - Change from UK to EU Plug
De-gassed			
0* VS1017	£103	€119	De-gassed Unit (Only Required to Make Suitable for Air Freighting)

0* Factory fitted option please request at point of ordering

Accessories

MODEL	PRICE £	PRICE €	DESCRIPTION
A A12/100	£126.70	€145.75	Chrome Wine Shelf
A A12/091/Z1	£63.35	€72.90	Chrome Wire Shelf
A S76/048	£39	€45	Perforated Shelf

2

UK parts
and labour
warranty

Export
parts
warranty

on all IMC products

Ventus V90

Ventus V90 Standard - 900mm High

- Wide range of options available to customise your bottle cooler, ensure a perfect fit in any bar
- Elegant, flexible storage for up to 195 bottles
- Dynamic Air Distribution System coupled with efficient compressors and improved insulation ensures superior cooling times
- Electronic temperature control keeps drinks at the perfect serving temperature
- Energy efficient EcoSmart controller - at the touch of a button, put the bottle cooler into its most economical state until next required
- Sleek stainless steel interior and LED lighting to enhance display
- Twin double-glazed lockable doors for enhanced security
- UK 3 pin plug allows users to simply plug in and switch on



Ventus V90 Standard - 900mm High											
MODEL	PRICE £	PRICE €	DESCRIPTION	DOOR HINGING	H	W	D	POWER	GAS TYPE	CAPACITY	WT
F76/250	£2981	€3429	Glass Door Stainless Steel	Left; Right	900	900	500	410W	R290	195 Bottles	86
F76/250/B	£2981	€3429	Glass Door Black Painted	Left; Right	900	900	500	410W	R290	195 Bottles	86

V90 Standard 900mm High Factory Fit Options

MODEL	PRICE £	PRICE €	DESCRIPTION
Door Type			
0* VS428	£60	€69	Solid Door - Stainless Steel - Change from Standard Glass to Solid Door
0* VS419	£60	€69	Solid Door - Black Painted - Change from Standard Glass to Solid Door
Shelving Type			
0* VS400	£203	€234	Perforated Shelving - Change from Standard Wire Shelves to Perforated Shelves
0* VS360	£39	€45	Wine Shelving - Change from Standard Wire Shelves to Wine Shelves
Plug Type			
0* VS401	£0	€0	EU 2-Pin Plug - Change from UK to EU Plug
De-gassed			
0* VS1017	£103	€119	De-gassed Unit (Only Required to Make Suitable for Air Freighting)

0* Factory fitted option please request at point of ordering

Accessories

MODEL	PRICE £	PRICE €	DESCRIPTION
A A12/101	£97.40	€112.05	Chrome Wine Shelf
A A12/092/Z1	£118.50	€136.30	Chrome Wire Shelf
A S76/047	£29	€34	Perforated Shelf

Ventus V90

Ventus V90 Reduced Height - 850mm High

- Reduced 850mm height
- Wide range of options available to customise your bottle cooler, ensure a perfect fit in any bar
- Elegant, flexible storage for up to 117 bottles
- Dynamic Air Distribution System coupled with efficient compressors and improved insulation ensures superior cooling times
- Electronic temperature control keeps drinks at the perfect serving temperature
- Energy efficient EcoSmart controller - at the touch of a button, put the bottle cooler into its most economical state until next required
- Sleek stainless steel interior and LED lighting to enhance display
- Twin double-glazed lockable doors for enhanced security
- UK 3 pin plug allows users to simply plug in and switch on



Ventus V90 Reduced Height - 850mm High											
MODEL	PRICE £	PRICE €	DESCRIPTION	DOOR HINGING	H	W	D	POWER	GAS TYPE	CAPACITY	WT
F76/251	£2981	€3429	Glass Door Stainless Steel	Left; Right	850	900	500	410W	R290	117 Bottles	85
F76/251/B	£2981	€3429	Glass Door Black Painted	Left; Right	850	900	500	410W	R290	117 Bottles	85

V90 Reduced Height 850mm High Factory Fit Options

MODEL	PRICE £	PRICE €	DESCRIPTION	
Door Type				
0*	VS429	£60	€69	Solid Door - Stainless Steel - Change from Standard Glass to Solid Door
0*	VS422	£60	€69	Solid Door - Black Painted - Change from Standard Glass to Solid Door
Shelving Type				
0*	VS400	£203	€234	Perforated Shelving - Change from Standard Wire Shelves to Perforated Shelves
0*	VS360	£39	€45	Wine Shelving - Change from Standard Wire Shelves to Wine Shelves
Plug Type				
0*	VS401	£0	€0	EU 2-Pin Plug - Change from UK to EU Plug
De-gassed				
0*	VS1017	£103	€119	De-gassed Unit (Only Required to Make Suitable for Air Freighting)

0* Factory fitted option please request at point of ordering

Accessories

MODEL	PRICE £	PRICE €	DESCRIPTION	
A	A12/101	£97.40	€112.05	Chrome Wine Shelf
A	A12/092/Z1	£118.50	€136.30	Chrome Wire Shelf
A	S76/047	£29	€34	Perforated Shelf

Ventus V90 Reduced Height - 800mm High

- Reduced 800mm height
- Wide range of options available to customise your bottle cooler, ensure a perfect fit in any bar
- Elegant, flexible storage for up to 117 bottles
- Dynamic Air Distribution System coupled with efficient compressors and improved insulation ensures superior cooling times
- Electronic temperature control keeps drinks at the perfect serving temperature
- Energy efficient EcoSmart controller - at the touch of a button, put the bottle cooler into its most economical state until next required
- Sleek stainless steel interior and LED lighting to enhance display
- Twin double-glazed lockable doors for enhanced security
- UK 3 pin plug allows users to simply plug in and switch on



Ventus V90 Reduced Height - 800mm High											
MODEL	PRICE £	PRICE €	DESCRIPTION	DOOR HINGING	H	W	D	POWER	GAS TYPE	CAPACITY	WT
F76/252	£2981	€3429	Glass Door Stainless Steel	Left; Right	800	900	500	410W	R290	117 Bottles	82
F76/252/B	£2981	€3429	Glass Door Black Painted	Left; Right	800	900	500	410W	R290	117 Bottles	82

V90 Reduced Height 800mm High Factory Fit Options

MODEL	PRICE £	PRICE €	DESCRIPTION	
Door Type				
0*	VS410	£60	€69	Solid Door - Stainless Steel - Change from Standard Glass to Solid Door
0*	VS425	£60	€69	Solid Door - Black Painted - Change from Standard Glass to Solid Door
Shelving Type				
0*	VS400	£203	€234	Perforated Shelving - Change from Standard Wire Shelves to Perforated Shelves
0*	VS360	£39	€45	Wine Shelving - Change from Standard Wire Shelves to Wine Shelves
Plug Type				
0*	VS401	£0	€0	EU 2-Pin Plug - Change from UK to EU Plug
De-gassed				
0*	VS1017	£103	€119	De-gassed Unit (Only Required to Make Suitable for Air Freighting)

0* Factory fitted option please request at point of ordering

Accessories

MODEL	PRICE £	PRICE €	DESCRIPTION	
A	A12/101	£97.40	€112.05	Chrome Wine Shelf
A	A12/092/Z1	£118.50	€136.30	Chrome Wire Shelf
A	S76/047	£29	€34	Perforated Shelf

2
YEAR

UK parts
and labour
warranty

Export
parts
warranty

on all IMC products

Ventus V90

Ventus V90 Reduced Depth - 450mm Deep

- Reduced 450mm depth
- Wide range of options available to customise your bottle cooler, ensure a perfect fit in any bar
- Elegant, flexible storage for up to 156 bottles
- Dynamic Air Distribution System coupled with efficient compressors and improved insulation ensures superior cooling times
- Electronic temperature control keeps drinks at the perfect serving temperature
- Energy efficient EcoSmart controller - at the touch of a button, put the bottle cooler into its most economical state until next required
- Sleek stainless steel interior and LED lighting to enhance display
- Twin double-glazed lockable doors for enhanced security
- UK 3 pin plug allows users to simply plug in and switch on



Ventus V90 Reduced Depth - 450mm Deep											
MODEL	PRICE £	PRICE €	DESCRIPTION	DOOR HINGING	H	W	D	POWER	GAS TYPE	CAPACITY	WT
F76/253	£2981	€3429	Glass Door Stainless Steel	Left; Right	900	900	450	410W	R290	156 Bottles	84
F76/253/B	£2981	€3429	Glass Door Black Painted	Left; Right	900	900	450	410W	R290	156 Bottles	84

V90 Reduced Depth 450mm Deep Factory Fit Options

MODEL	PRICE £	PRICE €	DESCRIPTION
Door Type			
0* VS428	£60	€69	Solid Door - Stainless Steel - Change from Standard Glass to Solid Door
0* VS419	£60	€69	Solid Door - Black Painted - Change from Standard Glass to Solid Door
Shelving Type			
0* VS403	£203	€234	Perforated Shelving - Change from Standard Wire Shelves to Perforated Shelves
Plug Type			
0* VS401	£0	€0	EU 2-Pin Plug - Change from UK to EU Plug
De-gassed			
0* VS1017	£103	€119	De-gassed Unit (Only Required to Make Suitable for Air Freighting)

0* Factory fitted option please request at point of ordering

Accessories

MODEL	PRICE £	PRICE €	DESCRIPTION
A S76/097	£79	€91	Chrome Wire Shelf
A S76/124	£60	€69	Perforated Shelf

Ventus V90 Full Front - 900mm High

- Full front door for seamless integration
- Wide range of options available to customise your bottle cooler, ensure a perfect fit in any bar
- Elegant, flexible storage for up to 195 bottles
- Dynamic Air Distribution System coupled with efficient compressors and improved insulation ensures superior cooling times
- Electronic temperature control keeps drinks at the perfect serving temperature
- Energy efficient EcoSmart controller - at the touch of a button, put the bottle cooler into its most economical state until next required
- Sleek stainless steel interior and LED lighting to enhance display
- Double-glazed doors for enhanced insulation
- UK 3 pin plug allows users to simply plug in and switch on



Ventus V90 Full Front - 900mm High											
MODEL	PRICE £	PRICE €	DESCRIPTION	DOOR HINGING	H	W	D	POWER	GAS TYPE	CAPACITY	WT
F76/270	£2981	€3429	Glass Door Stainless Steel	Left; Right	900	900	500	393W	R290	195 Bottles	86
F76/270/B	£2981	€3429	Glass Door Black Painted	Left; Right	900	900	500	393W	R290	195 Bottles	86

V90 Full Front Glass 900mm High Factory Fit Options

MODEL	PRICE £	PRICE €	DESCRIPTION
Door Type			
0* VS732	£60	€69	Solid Door - Stainless Steel - Change from Full Front Glass to Full Front Solid Door
0* VS744	£60	€69	Solid Door - Black Painted - Change from Full Front Glass to Full Front Solid Door
0* VS1012	£51	€59	Full Front Cladded Door - Stainless Steel - Change from Glass Door to Own Cladding - Customer Supplied Wood Panel
0* VS1029	£64	€74	Full Front Cladded Door - Black Painted - Change from Glass Door to Own Cladding - Customer Supplied Wood Panel
Shelving Type			
0* VS400	£203	€234	Perforated Shelving - Change from Standard Wire Shelves to Perforated Shelves
0* VS360	£39	€45	Wine Shelving - Change from Standard Wire Shelves to Wine Shelves
Plug Type			
0* VS401	£0	€0	EU 2-Pin Plug - Change from UK to EU Plug
De-gassed			
0* VS1017	£103	€119	De-gassed Unit (Only Required to Make Suitable for Air Freighting)

0* Factory fitted option please request at point of ordering

Accessories

MODEL	PRICE £	PRICE €	DESCRIPTION
A A12/101	£97.40	€112.05	Chrome Wine Shelf
A A12/092/Z1	£118.50	€136.30	Chrome Wire Shelf
A S76/047	£29	€34	Perforated Shelf

2
YEAR

 UK parts
and labour
warranty

 Export
parts
warranty

on all IMC products

Ventus V90

Ventus V90 Full Front - 850mm High

- Full front door for seamless integration
- Reduced 850mm height
- Wide range of options available to customise your bottle cooler, ensure a perfect fit in any bar
- Elegant, flexible storage for up to 117 bottles
- Dynamic Air Distribution System coupled with efficient compressors and improved insulation ensures superior cooling times
- Electronic temperature control keeps drinks at the perfect serving temperature
- Energy efficient EcoSmart controller - at the touch of a button, put the bottle cooler into its most economical state until next required
- Sleek stainless steel interior and LED lighting to enhance display
- Double-glazed doors for enhanced insulation
- UK 3 pin plug allows users to simply plug in and switch on



Ventus V90 Full Front - 850mm High											
MODEL	PRICE £	PRICE €	DESCRIPTION	DOOR HINGING	H	W	D	POWER	GAS TYPE	CAPACITY	WT
F76/271	£2981	€3429	Glass Door Stainless Steel	Left; Right	850	900	500	393W	R290	117 Bottles	85
F76/271/B	£2981	€3429	Glass Door Black Painted	Left; Right	850	900	500	393W	R290	117 Bottles	85

V90 Full Front Glass 850mm High Factory Fit Options

MODEL	PRICE £	PRICE €	DESCRIPTION
Door Type			
0* VS733	£60	€69	Solid Door - Stainless Steel - Change from Full Front Glass to Full Front Solid Door
0* VS745	£60	€69	Solid Door - Black Painted - Change from Full Front Glass to Full Front Solid Door
0* VS1013	£51	€59	Full Front Cladded Door - Stainless Steel - Change from Glass Door to Own Cladding - Customer Supplied Wood Panel
0* VS1030	£64	€74	Full Front Cladded Door - Black Painted - Change from Glass Door to Own Cladding - Customer Supplied Wood Panel
Shelving Type			
0* VS400	£203	€234	Perforated Shelving - Change from Standard Wire Shelves to Perforated Shelves
0* VS360	£39	€45	Wine Shelving - Change from Standard Wire Shelves to Wine Shelves
Plug Type			
0* VS401	£0	€0	EU 2-Pin Plug - Change from UK to EU Plug
De-gassed			
0* VS1017	£103	€119	De-gassed Unit (Only Required to Make Suitable for Air Freighting)

0* Factory fitted option please request at point of ordering

Accessories

MODEL	PRICE £	PRICE €	DESCRIPTION
A A12/101	£97.40	€112.05	Chrome Wine Shelf
A A12/092/Z1	£118.50	€136.30	Chrome Wire Shelf
A S76/047	£26	€30	Perforated Shelf

Ventus V90 Full Front - 800mm High

- Full front door for seamless integration
- Reduced 800mm height
- Wide range of options available to customise your bottle cooler, ensure a perfect fit in any bar
- Elegant, flexible storage for up to 117 bottles
- Dynamic Air Distribution System coupled with efficient compressors and improved insulation ensures superior cooling times
- Electronic temperature control keeps drinks at the perfect serving temperature
- Energy efficient EcoSmart controller - at the touch of a button, put the bottle cooler into its most economical state until next required
- Sleek stainless steel interior and LED lighting to enhance display
- Double-glazed doors for enhanced insulation
- UK 3 pin plug allows users to simply plug in and switch on



Ventus V90 Full Front - 800mm High											
MODEL	PRICE £	PRICE €	DESCRIPTION	DOOR HINGING	H	W	D	POWER	GAS TYPE	CAPACITY	WT
F76/272	£2981	€3429	Glass Door Stainless Steel	Left; Right	800	900	500	393W	R290	117 Bottles	81
F76/272/B	£2981	€3429	Glass Door Black Painted	Left; Right	800	900	500	393W	R290	117 Bottles	81

V90 Full Front Glass 800mm High Factory Fit Options

MODEL	PRICE £	PRICE €	DESCRIPTION
Door Type			
0* VS734	£60	€69	Solid Door - Stainless Steel - Change from Full Front Glass to Full Front Solid Door
0* VS746	£60	€69	Solid Door - Black Painted - Change from Full Front Glass to Full Front Solid Door
0* VS1014	£51	€59	Full Front Cladded Door - Stainless Steel - Change from Glass Door to Own Cladding - Customer Supplied Wood Panel
0* VS1031	£64	€74	Full Front Cladded Door - Black Painted - Change from Glass Door to Own Cladding - Customer Supplied Wood Panel
Shelving Type			
0* VS400	£203	€234	Perforated Shelving - Change from Standard Wire Shelves to Perforated Shelves
0* VS360	£39	€45	Wine Shelving - Change from Standard Wire Shelves to Wine Shelves
Plug Type			
0* VS401	£0	€0	EU 2-Pin Plug - Change from UK to EU Plug
De-gassed			
0* VS1017	£103	€119	De-gassed Unit (Only Required to Make Suitable for Air Freighting)

0* Factory fitted option please request at point of ordering

Accessories

MODEL	PRICE £	PRICE €	DESCRIPTION
A A12/101	£97.40	€112.05	Chrome Wine Shelf
A A12/092/Z1	£118.50	€136.30	Chrome Wire Shelf
A S76/047	£29	€34	Perforated Shelf

2
YEAR

UK parts
and labour
warranty

Export
parts
warranty

on all IMC products

Ventus V135

Ventus V135 Standard - 900mm High

- Wide range of options available to customise your bottle cooler, ensure a perfect fit in any bar
- Elegant, flexible storage for up to 310 bottles
- Dynamic Air Distribution System coupled with efficient compressors and improved insulation ensures superior cooling times
- Electronic temperature control keeps drinks at the perfect serving temperature
- Energy efficient EcoSmart controller - at the touch of a button, put the bottle cooler into its most economical state until next required
- Sleek stainless steel interior and LED lighting to enhance display
- Three double-glazed lockable doors for enhanced security
- UK 3 pin plug allows users to simply plug in and switch on



Ventus V135 Standard - 900mm High											
MODEL	PRICE £	PRICE €	DESCRIPTION	DOOR HINGING	H	W	D	POWER	GAS TYPE	CAPACITY	WT
F76/350	£4603	€5294	Glass Door Stainless Steel	Left; Right; Right	900	1350	500	664W	R290	310 Bottles	133
F76/350/B	£4603	€5294	Glass Door Black Painted	Left; Right; Right	900	1350	500	664W	R290	310 Bottles	133

V135 Standard 900mm High Factory Fit Options

MODEL	PRICE £	PRICE €	DESCRIPTION
Door Type			
0* VS537	£92	€106	Solid Door - Stainless Steel - Change from Standard Glass to Solid Door
0* VS1007	£92	€106	Solid Door - Black Painted - Change from Standard Glass to Solid Door
Shelving Type			
0* VS587	£250	€288	Perforated Shelving - Change from Standard Wire Shelves to Perforated Shelves
0* VS439	£39	€45	Wine Shelving - Change from Standard Wire Shelves to Wine Shelves
Plug Type			
0* VS401	£0	€0	EU 2-Pin Plug - Change from UK to EU Plug
De-gassed			
0* VS1017	£103	€119	De-gassed Unit (Only Required to Make Suitable for Air Freighting)

0* Factory fitted option please request at point of ordering

Accessories

MODEL	PRICE £	PRICE €	DESCRIPTION
A A12/102	£126.50	€145.50	Chrome Wine Shelf
A A12/099	£117.30	€134.90	Chrome Wire Shelf
A S76/153	£197.80	€227.50	Perforated Shelf

Ventus V135 Reduced Height - 800mm

- Reduced 800mm height
- Wide range of options available to customise your bottle cooler, ensure a perfect fit in any bar
- Elegant, flexible storage for up to 195 bottles
- Dynamic Air Distribution System coupled with efficient compressors and improved insulation ensures superior cooling times
- Electronic temperature control keeps drinks at the perfect serving temperature
- Energy efficient EcoSmart controller - at the touch of a button, put the bottle cooler into its most economical state until next required
- Sleek stainless steel interior and LED lighting to enhance display
- Three double-glazed lockable doors for enhanced security
- UK 3 pin plug allows users to simply plug in and switch on



Ventus V135 Reduced Height - 800mm											
MODEL	PRICE £	PRICE €	DESCRIPTION	DOOR HINGING	H	W	D	POWER	GAS TYPE	CAPACITY	WT
F76/352	£4184	€4812	Glass Door Stainless Steel	Left; Right; Right	800	1350	500	664W	R290	185 Bottles	128
F76/352/B	£4184	€4812	Glass Door Black Painted	Left; Right; Right	800	1350	500	664W	R290	185 Bottles	128

V135 Standard 800mm High Factory Fit Options

MODEL	PRICE £	PRICE €	DESCRIPTION
Door Type			
0* VS538	£92	€106	Solid Door - Stainless Steel - Change from Standard Glass to Solid Door
0* VS868	£92	€106	Solid Door - Black Painted - Change from Standard Glass to Solid Door
Shelving Type			
0* VS587	£250	€288	Perforated Shelving - Change from Standard Wire Shelves to Perforated Shelves
0* VS439	£39	€45	Wine Shelving - Change from Standard Wire Shelves to Wine Shelves
Plug Type			
0* VS401	£0	€0	EU 2-Pin Plug - Change from UK to EU Plug
De-gassed			
0* VS1017	£103	€119	De-gassed Unit (Only Required to Make Suitable for Air Freighting)

0* Factory fitted option please request at point of ordering

Accessories

MODEL	PRICE £	PRICE €	DESCRIPTION
A A12/102	£126.50	€145.50	Chrome Wine Shelf
A A12/099	£117.30	€134.90	Chrome Wire Shelf
A S76/153	£197.80	€227.50	Perforated Shelf

2
YEAR

UK parts
and labour
warranty

Export
parts
warranty

on all IMC products

Ventus V135

Ventus V135 Full Front - 900mm High

- Full front door for seamless integration
- Wide range of options available to customise your bottle cooler, ensure a perfect fit in any bar
- Elegant, flexible storage for up to 310 bottles
- Dynamic Air Distribution System coupled with efficient compressors and improved insulation ensures superior cooling times
- Electronic temperature control keeps drinks at the perfect serving temperature
- Energy efficient EcoSmart controller - at the touch of a button, put the bottle cooler into its most economical state until next required
- Sleek stainless steel interior and LED lighting to enhance display
- Three double-glazed lockable doors for enhanced security
- UK 3 pin plug allows users to simply plug in and switch on



Ventus V135 Full Front - 900mm High											
MODEL	PRICE £	PRICE €	DESCRIPTION	DOOR HINGING	H	W	D	POWER	GAS TYPE	CAPACITY	WT
F76/370	£4603	€5294	Glass Door Stainless Steel	Left; Right; Right	900	1350	500	664W	R290	310 Bottles	133
F76/370/B	£4603	€5294	Glass Door Black Painted	Left; Right; Right	900	1350	500	664W	R290	310 Bottles	133

V135 Full Front Glass 900mm High Factory Fit Options

MODEL	PRICE £	PRICE €	DESCRIPTION
Door Type			
0* VS735	£92	€106	Solid Door - Stainless Steel - Change from Full Front Glass to Full Front Solid Door
0* VS747	£92	€106	Solid Door - Black Painted - Change from Full Front Glass to Full Front Solid Door
0* VS1015	£77	€89	Full Front Cladded Door - Stainless Steel - Change from Glass Door to Own Cladding - Customer Supplied Wood Panel
0* VS1032	£96	€111	Full Front Cladded Door - Black Painted - Change from Glass Door to Own Cladding - Customer Supplied Wood Panel
Shelving Type			
0* VS587	£250	€288	Perforated Shelving - Change from Standard Wire Shelves to Perforated Shelves
0* VS439	£39	€45	Wine Shelving - Change from Standard Wire Shelves to Wine Shelves
Plug Type			
0* VS401	£0	€0	EU 2-Pin Plug - Change from UK to EU Plug
De-gassed			
0* VS1017	£103	€119	De-gassed Unit (Only Required to Make Suitable for Air Freight)

0* Factory fitted option please request at point of ordering

Accessories

MODEL	PRICE £	PRICE €	DESCRIPTION
A A12/102	£126.50	€145.50	Chrome Wine Shelf
A A12/099	£117.30	€134.90	Chrome Wire Shelf
A S76/153	£197.80	€227.50	Perforated Shelf

Ventus V135 Full Front - 800mm High

- Reduced 800mm height
- Wide range of options available to customise your bottle cooler, ensure a perfect fit in any bar
- Elegant, flexible storage for up to 195 bottles
- Dynamic Air Distribution System coupled with efficient compressors and improved insulation ensures superior cooling times
- Electronic temperature control keeps drinks at the perfect serving temperature
- Energy efficient EcoSmart controller - at the touch of a button, put the bottle cooler into its most economical state until next required
- Sleek stainless steel interior and LED lighting to enhance display
- Three double-glazed lockable doors for enhanced security
- UK 3 pin plug allows users to simply plug in and switch on



Ventus V135 Full Front - 800mm High											
MODEL	PRICE £	PRICE €	DESCRIPTION	DOOR HINGING	H	W	D	POWER	GAS TYPE	CAPACITY	WT
F76/372	£4184	€4812	Glass Door Stainless Steel	Left; Right; Right	800	1350	500	664W	R290	185 Bottles	128
F76/372/B	£4184	€4812	Glass Door Black Painted	Left; Right; Right	800	1350	500	664W	R290	185 Bottles	128

V135 Full Front Glass 800mm High Factory Fit Options

MODEL	PRICE £	PRICE €	DESCRIPTION
Door Type			
0* VS737	£92	€106	Solid Door - Stainless Steel - Change from Full Front Glass to Full Front Solid Door
0* VS749	£92	€106	Solid Door - Black Painted - Change from Full Front Glass to Full Front Solid Door
0* VS1016	£77	€89	Full Front Cladded Door - Stainless Steel - Change from Glass Door to Own Cladding - Customer Supplied Wood Panel
0* VS1033	£96	€111	Full Front Cladded Door - Black Painted - Change from Glass Door to Own Cladding - Customer Supplied Wood Panel
Shelving Type			
0* VS587	£250	€288	Perforated Shelving - Change from Standard Wire Shelves to Perforated Shelves
0* VS439	£39	€45	Wine Shelving - Change from Standard Wire Shelves to Wine Shelves
Plug Type			
0* VS401	£0	€0	EU 2-Pin Plug - Change from UK to EU Plug
De-gassed			
0* VS1017	£103	€119	De-gassed Unit (Only Required to Make Suitable for Air Freight)

0* Factory fitted option please request at point of ordering

Accessories

MODEL	PRICE £	PRICE €	DESCRIPTION
A A12/102	£126.50	€145.50	Chrome Wine Shelf
A A12/099	£117.30	€134.90	Chrome Wire Shelf
A S76/153	£197.80	€227.50	Perforated Shelf

2 YEAR
UK parts and labour
warranty | Export parts
warranty
on all IMC products

Ventus VR60

Ventus VR60 Glass Froster - 900mm High

- Wide range of options available to customise your glass froster, ensure a perfect fit in any bar
- Chills and frosts glasses, to enhance the taste and appearance of drinks
- Dynamic Air Distribution System coupled with efficient compressors and improved insulation ensures superior cooling times
- Rapid chill to -10°C to keep drinks colder for longer
- Energy efficient EcoSmart controller - at the touch of a button, put the glass froster into its most economical state until next required
- Efficient design means up to 50 pint glasses can be chilled at the same time
- Front loading design ensures fast and easy access to ice cold glasses
- Stylish stainless steel exterior to suit any commercial bar setting
- UK 3 pin plug - simply plug in and switch on



Ventus VR60 Glass Froster - 900mm High											
MODEL	PRICE £	PRICE €	DESCRIPTION	DOOR HINGING	H	W	D	POWER	CAPACITY		WT
F49/600	£2920	€3358	Glass Door Stainless Steel	Right	900	600	500	667W	50 x standard pint glasses		65
F49/600/B	£2920	€3358	Glass Door Black Painted	Right	900	600	500	667W	50 x standard pint glasses		65

VR60 Standard 900mm High Factory Fit Options

MODEL	PRICE £	PRICE €	DESCRIPTION
Door Type			
0* VS644	£36	€42	Solid Door - Stainless Steel - Change from Standard Glass to Solid Door
0* VS794	£36	€42	Solid Door - Black Painted - Change from Standard Glass to Solid Door
0* VS642	£31	€36	Left Hinged Glass Door - Stainless Steel - Change from Standard Glass to Left Hinged Glass Door
0* VS1008	£31	€36	Left Hinged Glass Door - Black Painted - Change from Standard Glass to Left Hinged Glass Door
0* VS646	£31	€36	Left Hinged Solid Door - Stainless Steel - Change from Standard Solid to Left Hinged Solid Door
0* VS796	£31	€36	Left Hinged Solid Door - Black Painted - Change from Standard Solid to Left Hinged Solid Door
Shelving Type			
0* VS399	£157	€181	Perforated Shelving - Change from Standard Wire Shelves to Perforated Shelves
0* VS359	£39	€45	Wine Shelving - Change from Standard Wire Shelves to Wine Shelves
Plug Type			
0* VS401	£0	€0	EU 2-Pin Plug - Change from UK to EU Plug
De-gassed			
0* VS1017	£103	€119	De-gassed Unit (Only Required to Make Suitable for Air Freightling)

0* Factory fitted option please request at point of ordering

Ventus VR60 Glass Froster - 800mm High

- Reduced 800mm height
- Wide range of options available to customise your glass froster, ensure a perfect fit in any bar
- Chills and frosts glasses, to enhance the taste and appearance of drinks
- Dynamic Air Distribution System coupled with efficient compressors and improved insulation ensures superior cooling times
- Rapid chill to -10°C to keep drinks colder for longer
- Energy efficient EcoSmart controller - at the touch of a button, put the glass froster into its most economical state until next required
- Efficient design means up to 50 pint glasses can be chilled at the same time
- Front loading design ensures fast and easy access to ice cold glasses
- Stylish stainless steel exterior to suit any commercial bar setting
- UK 3 pin plug - simply plug in and switch on



Ventus VR60 Glass Froster - 800mm High											
MODEL	PRICE £	PRICE €	DESCRIPTION	DOOR HINGING	H	W	D	POWER	CAPACITY		WT
F49/602	£2920	€3358	Glass Door Stainless Steel	Right	800	600	500	667W	50 x standard pint glasses		65
F49/602/B	£2920	€3358	Glass Door Black Painted	Right	800	600	500	667W	50 x standard pint glasses		65

VR60 Standard 800mm High Factory Fit Options

MODEL	PRICE £	PRICE €	DESCRIPTION
Door Type			
0* VS645	£36	€42	Solid Door - Stainless Steel - Change from Standard Glass to Solid Door
0* VS795	£36	€42	Solid Door - Black Painted - Change from Standard Glass to Solid Door
0* VS643	£31	€36	Left Hinged Glass Door - Stainless Steel - Change from Standard Glass to Left Hinged Glass Door
0* VS838	£31	€36	Left Hinged Glass Door - Black Painted - Change from Standard Glass to Left Hinged Glass Door
0* VS647	£31	€36	Left Hinged Solid Door - Stainless Steel - Change from Standard Solid to Left Hinged Solid Door
0* VS797	£31	€36	Left Hinged Solid Door - Black Painted - Change from Standard Solid to Left Hinged Solid Door
Shelving Type			
0* VS399	£157	€181	Perforated Shelving - Change from Standard Wire Shelves to Perforated Shelves
0* VS359	£39	€45	Wine Shelving - Change from Standard Wire Shelves to Wine Shelves
Plug Type			
0* VS401	£0	€0	EU 2-Pin Plug - Change from UK to EU Plug
De-gassed			
0* VS1017	£103	€119	De-gassed Unit (Only Required to Make Suitable for Air Freighting)

0* Factory fitted option please request at point of ordering

Ventus VR60

Ventus VR60 Full Front Glass Froster - 900mm High

- Full front door for seamless integration
- Wide range of options available to customise your glass froster, ensure a perfect fit in any bar
- Chills and frosts glasses, to enhance the taste and appearance of drinks
- Dynamic Air Distribution System coupled with efficient compressors and improved insulation ensures superior cooling times
- Rapid chill to -10°C to keep drinks colder for longer
- Energy efficient EcoSmart controller - at the touch of a button, put the glass froster into its most economical state until next required
- Efficient design means up to 50 pint glasses can be chilled at the same time
- Front loading design ensures fast and easy access to ice cold glasses
- Stylish stainless steel exterior to suit any commercial bar setting
- UK 3 pin plug - simply plug in and switch on



Ventus VR60 Full Front Glass Froster - 900mm High											
MODEL	PRICE £	PRICE €	DESCRIPTION	DOOR HINGING	H	W	D	POWER	CAPACITY		WT
F49/620	£2920	€3358	Glass Door Stainless Steel	Right	900	600	500	667W	50 x standard pint glasses		65
F49/620/B	£2920	€3358	Glass Door Black Painted	Right	900	600	500	667W	50 x standard pint glasses		65

VR60 Full Front 900mm High Factory Fit Options

MODEL	PRICE £	PRICE €	DESCRIPTION
Door Type			
0* VS804	£54	€63	Solid Door - Stainless Steel - Change from Standard Glass to Solid Door
0* VS805	£22	€26	Solid Door - Black Painted - Change from Standard Glass to Solid Door
0* VS918	£37	€43	Left Hinged Glass Door - Stainless Steel - Change from Standard Glass to Left Hinged Glass Door
0* VS1019	£37	€43	Left Hinged Glass Door - Black Painted - Change from Standard Glass to Left Hinged Glass Door
0* VS833	£44	€51	Left Hinged Solid Door - Stainless Steel - Change from Standard Solid to Left Hinged Solid Door
0* VS1021	£57	€66	Left Hinged Solid Door - Black Painted - Change from Standard Solid to Left Hinged Solid Door
0* VS771	£37	€43	Door for Wood Cladding - Stainless Steel - Change from Standard to Frame for Wood Cladding
0* VS772	£37	€43	Door for Wood Cladding - Black Painted - Change from Standard to Frame for Wood Cladding
0* VS777	£33	€38	Left Hinged Door for Wood Cladding - Stainless Steel - Change from Standard to Left Hinged Frame for Wood Cladding
0* VS778	£33	€38	Left Hinged Door for Wood Cladding - Black Painted - Change from Standard to Left Hinged Frame for Wood Cladding
Shelving Type			
0* VS399	£157	€181	Perforated Shelving - Change from Standard Wire Shelves to Perforated Shelves
0* VS359	£39	€45	Wine Shelving - Change from Standard Wire Shelves to Wine Shelves
Plug Type			
0* VS401	£0	€0	EU 2-Pin Plug - Change from UK to EU Plug
De-gassed			
0* VS1017	£103	€119	De-gassed Unit (Only Required to Make Suitable for Air Freighting)

0* Factory fitted option please request at point of ordering

2

UK parts and labour
warranty

Export parts
warranty

on all IMC products

Ventus VR60 Full Front Glass Froster - 800mm High

- Full front door for seamless integration
- Reduced 800mm height
- Wide range of options available to customise your glass froster, ensure a perfect fit in any bar
- Chills and frosts glasses, to enhance the taste and appearance of drinks
- Dynamic Air Distribution System coupled with efficient compressors and improved insulation ensures superior cooling times
- Rapid chill to -10°C to keep drinks colder for longer
- Energy efficient EcoSmart controller - at the touch of a button, put the glass froster into its most economical state until next required
- Efficient design means up to 50 pint glasses can be chilled at the same time
- Front loading design ensures fast and easy access to ice cold glasses
- Stylish stainless steel exterior to suit any commercial bar setting
- UK 3 pin plug - simply plug in and switch on



Ventus VR60 Full Front Glass Froster - 800mm High											
MODEL	PRICE £	PRICE €	DESCRIPTION	DOOR HINGING	H	W	D	POWER	CAPACITY		WT
F49/622	£2920	€3358	Glass Door Stainless Steel	Right	800	600	500	687W	50 x standard pint glasses		65
F49/622/B	£2920	€3358	Glass Door Black Painted	Right	800	600	500	687W	50 x standard pint glasses		65

VR60 Full Front 800mm High Factory Fit Options

MODEL	PRICE £	PRICE €	DESCRIPTION
Door Type			
0* VS808	£32	€37	Solid Door - Stainless Steel - Change from Standard Glass to Solid Door
0* VS1018	£39	€45	Solid Door - Black Painted - Change from Standard Glass to Solid Door
0* VS917	£37	€43	Left Hinged Glass Door - Stainless Steel - Change from Standard Glass to Left Hinged Glass Door
0* VS1020	£37	€43	Left Hinged Glass Door - Black Painted - Change from Standard Glass to Left Hinged Glass Door
0* VS1022	£57	€66	Left Hinged Solid Door - Stainless Steel - Change from Standard Solid to Left Hinged Solid Door
0* VS1023	£57	€66	Left Hinged Solid Door - Black Painted - Change from Standard Solid to Left Hinged Solid Door
0* VS768	£37	€43	Door for Wood Cladding - Stainless Steel - Change from Standard to Frame for Wood Cladding
0* VS769	£37	€43	Door for Wood Cladding - Black Painted - Change from Standard to Frame for Wood Cladding
0* VS774	£33	€38	Left Hinged Door for Wood Cladding - Stainless Steel - Change from Standard to Left Hinged Frame for Wood Cladding
0* VS775	£33	€38	Left Hinged Door for Wood Cladding - Black Painted - Change from Standard to Left Hinged Frame for Wood Cladding
Shelving Type			
0* VS399	£157	€181	Perforated Shelving - Change from Standard Wire Shelves to Perforated Shelves
0* VS359	£39	€45	Wine Shelving - Change from Standard Wire Shelves to Wine Shelves
Plug Type			
0* VS401	£0	€0	EU 2-Pin Plug - Change from UK to EU Plug
De-gassed			
0* VS1017	£103	€119	De-gassed Unit (Only Required to Make Suitable for Air Freighting)

0* Factory fitted option please request at point of ordering



Mistral



Whether it's keeping beverages at perfect serving temperature or frosting glasses to enhance the appearance of drinks, we have an array of solutions.

We offer a wide variety of bottle coolers to suit any bar setting. With precise temperature control and rapid chill, our energy-efficient bottle coolers are the perfect showcase for drinks. Mistral models allow easy access for quick service and are available in a range of stylish designs and space-saving sizes.

With rapid chill, our energy-efficient range of glass frosters helps bars to deliver high-quality drinks every time. Mistral provides easy access for quick service and is available in a range of sleek designs, with varying capacities.

Ideally suited for...



Bars

Speed up service and generate customer satisfaction with great-tasting drinks.



Restaurants

Enhance your customers' dining experience by serving high-quality drinks alongside delicious food. Make sure they are perfectly-presented and taste great with Mistral.



Hotels

Attract customers in your hotel's bar with a stylish bottle cooler or glass froster. Show your drinks in their best light in a well-designed unit that enhances your offer.



Cafes and coffee shops

Encourage customers to spend by tempting them with well-presented drinks. Highlight your offer and ensure great-tasting beverages with a Mistral unit.

Deliver ice cold drinks with visual appeal with Mistral bottle coolers and glass frosters.

Benefits at a glance

- Chills bottles and frosts glasses to add visual appeal to drinks
- Precise temperature control
- Stylish exterior design
- Large capacity

Mistral M60

Mistral M60 Standard - 900mm High

- Stylish, flexible storage for up to 120 bottles
- Electronic temperature controller and auto defrost for perfectly-chilled drinks
- Energy-efficient forced air cooling for rapid temperature pull down
- Sleek stainless steel interior to enhance display
- Single double-glazed lockable door for enhanced security
- UK 3 pin plug allows users to simply plug in and switch on
- Easy to remove and replace magnetic gaskets to facilitate cleaning



Mistral M60 Standard - 900mm high											
MODEL	PRICE £	PRICE €	DESCRIPTION	DOOR HINGING	H	W	D	POWER	GAS TYPE	CAPACITY	WT
F77/150	£1833	€2108	Glass Door Stainless Steel	Right	900	600	500	225W	R290	120 Bottles	65
F77/150/B	£1833	€2108	Glass Door Black Painted	Right	900	600	500	225W	R290	120 Bottles	65

MODEL	PRICE £	PRICE €	DESCRIPTION
A A12/100	£97.40	€112.05	Chrome Wine Shelf
A A12/091/Z1	£63.35	€72.90	Chrome Wire Shelf
0* VS1017	£103	€119	De-gassed unit (only required to make suitable for Air Freight)

0* Factory fitted option please request at point of ordering

Mistral M60 Reduced Height - 850mm High

- Reduced 850mm height
- Stylish, flexible storage for up to 78 bottles
- Electronic temperature controller and auto defrost for perfectly-chilled drinks
- Energy-efficient forced air cooling for rapid temperature pull down
- Sleek stainless steel interior to enhance display
- Single double-glazed lockable door for enhanced security
- UK 3 pin plug allows users to simply plug in and switch on
- Easy to remove and replace magnetic gaskets to facilitate cleaning



Mistral M60 Reduced Height - 850mm high											
MODEL	PRICE £	PRICE €	DESCRIPTION	DOOR HINGING	H	W	D	POWER	GAS TYPE	CAPACITY	WT
F77/151	£1833	€2108	Glass Door Stainless Steel	Right	850	600	500	225W	R290	78 Bottles	58
F77/151/B	£1833	€2108	Glass Door Black Painted	Right	850	600	500	225W	R290	78 Bottles	58

MODEL	PRICE £	PRICE €	DESCRIPTION
A A12/100	£97.40	€112.05	Chrome Wine Shelf
A A12/091/Z1	£63.35	€72.90	Chrome Wire Shelf
0* VS1017	£103	€119	De-gassed unit (only required to make suitable for Air Freight)

0* Factory fitted option please request at point of ordering

Mistral M60

Mistral M60 Reduced Height - 800mm High

- Reduced 800mm height
- Stylish, flexible storage for up to 78 bottles
- Electronic temperature controller and auto defrost for perfectly-chilled drinks
- Energy-efficient forced air cooling for rapid temperature pull down
- Sleek stainless steel interior to enhance display
- Single double-glazed lockable door for enhanced security
- UK 3 pin plug allows users to simply plug in and switch on
- Easy to remove and replace magnetic gaskets to facilitate cleaning



Mistral M60 Standard - 900mm high											
MODEL	PRICE £	PRICE €	DESCRIPTION	DOOR HINGING	H	W	D	POWER	GAS TYPE	CAPACITY	WT
F77/152	£1833	€2108	Glass Door Stainless Steel	Right	800	600	500	225W	R290	120 Bottles	57
F77/152/B	£1833	€2108	Glass Door Black Painted	Right	800	600	500	225W	R290	120 Bottles	57

MODEL	PRICE £	PRICE €	DESCRIPTION
A A12/100	£97.40	€112.05	Chrome Wine Shelf
A A12/091/Z1	£63.35	€72.90	Chrome Wire Shelf
0* VS1017	£103	€119	De-gassed unit (only required to make suitable for Air Freight)

0* Factory fitted option please request at point of ordering

Mistral M60 - High Ambient

- Stylish storage of up to 135 bottles in ambient conditions of up to 43°C
- Electronic temperature controller and auto defrost for perfectly-chilled drinks
- Energy-efficient forced air cooling for rapid temperature pull down
- Sleek stainless steel interior to enhance display
- Single double-glazed or solid lockable door for enhanced security
- UK 3 pin plug allows users to simply plug in and switch on
- Easy to remove and replace magnetic gaskets to facilitate cleaning



Mistral M60 - High Ambient											
MODEL	PRICE £	PRICE €	DESCRIPTION	DOOR HINGING	H	W	D	POWER	GAS TYPE	CAPACITY	WT
F77/114/SS	£2753	€3166	Glass Door Stainless Steel	Right	900	600	500	219W	R290	135 Bottles	64.5
F77/115/SS	£2753	€3166	Solid Door Stainless Steel	Right	900	600	500	219W	R290	135 Bottles	64.5

MODEL	PRICE £	PRICE €	DESCRIPTION
A A12/100	£97.40	€112.05	Chrome Wine Shelf
A A12/091/Z1	£63.35	€72.90	Chrome Wire Shelf
0* VS1017	£103	€119	De-gassed unit (only required to make suitable for Air Freight)

0* Factory fitted option please request at point of ordering

Mistral M90

Mistral M90 Standard - 900mm High

- Stylish, flexible storage for up to 195 bottles
- Electronic temperature controller and auto defrost for perfectly-chilled drinks
- Energy-efficient forced air cooling for rapid temperature pull down
- Sleek stainless steel interior to enhance display
- Double-glazed lockable doors for enhanced security
- UK 3 pin plug allows users to simply plug in and switch on
- Easy to remove and replace magnetic gaskets to facilitate cleaning



Mistral M90 Standard - 900mm high											
MODEL	PRICE £	PRICE €	DESCRIPTION	DOOR HINGING	H	W	D	POWER	GAS TYPE	CAPACITY	WT
F77/250	£2522	€2901	Glass Door Stainless Steel	Left, Right	900	900	500	232W	R290	195 Bottles	80
F77/250/B	£2522	€2901	Glass Door Black Painted	Left, Right	900	900	500	232W	R290	195 Bottles	80

MODEL	PRICE £	PRICE €	DESCRIPTION
A A12/101	£97.40	€112.05	Chrome Wine Shelf
A A12/092/Z1	£63.35	€72.90	Chrome Wire Shelf
0* VS1017	£103	€119	De-gassed unit (only required to make suitable for Air Freight)

0* Factory fitted option please request at point of ordering

Mistral M90 - With Sliding Doors

- Stylish, flexible storage for up to 204 bottles
- Electronic temperature controller and auto defrost for perfectly-chilled drinks
- Energy-efficient forced air cooling for rapid temperature pull down
- Sleek stainless steel interior to enhance display
- Sliding, lockable doors for enhanced security
- UK 3 pin plug allows users to simply plug in and switch on
- Easy to remove and replace magnetic gaskets to facilitate cleaning



Mistral M90 - With sliding doors											
MODEL	PRICE £	PRICE €	DESCRIPTION	DOOR HINGING	H	W	D	POWER	GAS TYPE	CAPACITY	WT
F77/700/SS	£2681	€3084	Glass Door Stainless Steel	Sliding	900	900	520	460W	R290	204 Bottles	86
F77/700/BS	£2681	€3084	Glass Door Black Painted	Sliding	900	900	520	460W	R290	204 Bottles	86

MODEL	PRICE £	PRICE €	DESCRIPTION
A A12/101	£97.40	€112.05	Chrome Wine Shelf
A A12/092/Z1	£63.35	€72.90	Chrome Wire Shelf
0* VS1017	£103	€119	De-gassed unit (only required to make suitable for Air Freight)

0* Factory fitted option please request at point of ordering

Mistral M90

Mistral M90 Reduced Height - 850mm High

- Reduced 850mm height
- Stylish, flexible storage for up to 117 bottles
- Precise electronic temperature controller and auto defrost for perfectly-chilled drinks

- Energy-efficient forced air cooling for rapid temperature pull down
- Sleek stainless steel interior to enhance display
- Double-glazed lockable doors for enhanced security
- UK 3 pin plug allows users to simply plug in and switch on



Mistral M90 Reduced Height - 850mm high											
MODEL	PRICE £	PRICE €	DESCRIPTION	DOOR HINGING	H	W	D	POWER	GAS TYPE	CAPACITY	WT
F77/251	£2522	€2901	Glass Door Stainless Steel	Left, Right	850	900	500	232W	R290	117 Bottles	77
F77/251/B	£2522	€2901	Glass Door Black Painted	Left, Right	850	900	500	232W	R290	117 Bottles	77

MODEL	PRICE £	PRICE €	DESCRIPTION
A A12/101	£97.40	€112.05	Chrome Wine Shelf
A A12/092/Z1	£63.35	€72.90	Chrome Wire Shelf
0* VS1017	£103	€119	De-gassed unit (only required to make suitable for Air Freight)

0* Factory fitted option please request at point of ordering

Mistral M90 Reduced Height - 800mm High

- Reduced 800mm height
- Stylish, flexible storage for up to 117 bottles
- Precise electronic temperature controller and auto defrost for perfectly-chilled drinks

- Energy-efficient forced air cooling for rapid temperature pull down
- Sleek stainless steel interior to enhance display
- Double-glazed lockable doors for enhanced security
- UK 3 pin plug allows users to simply plug in and switch on.



Mistral M90 Reduced Height - 800mm high											
MODEL	PRICE £	PRICE €	DESCRIPTION	DOOR HINGING	H	W	D	POWER	GAS TYPE	CAPACITY	WT
F77/252	£2522	€2901	Glass Door Stainless Steel	Left, Right	800	900	500	232W	R290	117 Bottles	74
F77/252/B	£2522	€2901	Glass Door Black Painted	Left, Right	800	900	500	232W	R290	117 Bottles	74

MODEL	PRICE £	PRICE €	DESCRIPTION
A A12/101	£97.40	€112.05	Chrome Wine Shelf
A A12/092/Z1	£63.35	€72.90	Chrome Wire Shelf
0* VS1017	£103	€119	De-gassed unit (only required to make suitable for Air Freight)

0* Factory fitted option please request at point of ordering

Mistral M90

Mistral M90 - High Ambient

- Stylish storage of up to 204 bottles in ambient conditions of up to 43°C
- Precise electronic temperature controller and auto defrost for perfectly-chilled drinks
- Energy-efficient forced air cooling for rapid temperature pull down
- Sleek stainless steel interior to enhance display
- Double-glazed lockable doors for enhanced security
- UK 3 pin plug allows users to simply plug in and switch on
- Easy to remove and replace magnetic gaskets to facilitate cleaning
- Ambient temperatures to 43°C



Mistral M90 - High ambient											
MODEL	PRICE £	PRICE €	DESCRIPTION	DOOR HINGING	H	W	D	POWER	GAS TYPE	CAPACITY	WT
F77/232/SS	£4768	€5484	Glass Door Stainless Steel	Left, Right	900	900	500	354W	R290	204 Bottles	85.5
F77/233/SS	£4768	€5484	Glass Door Black Painted	Left, Right	900	900	500	354W	R290	204 Bottles	85.5

MODEL	PRICE £	PRICE €	DESCRIPTION
A A12/101	£97.40	€112.05	Chrome Wine Shelf
A A12/092/Z1	£63.35	€72.90	Chrome Wire Shelf
0* VS1017	£103	€119	De-gassed unit (only required to make suitable for Air Freight)

0* Factory fitted option please request at point of ordering

Mistral M135

Mistral M135 Standard - 900mm High

- Stylish, flexible storage for up to 310 bottles
- Precise electronic temperature controller and auto defrost for perfectly-chilled drinks
- Energy-efficient forced air cooling for rapid temperature pull down
- Sleek stainless steel interior to enhance display
- Double-glazed lockable doors for enhanced security
- UK 3 pin plug allows users to simply plug in and switch on
- Easy to remove and replace magnetic gaskets to facilitate cleaning



Mistral M135 Standard - 900mm high											
MODEL	PRICE £	PRICE €	DESCRIPTION	DOOR HINGING	H	W	D	POWER	GAS TYPE	CAPACITY	WT
F77/350	£3796	€4366	Glass Door Stainless Steel	Left & 2 x Right	900	1350	500	357W	R290	310 Bottles	119.5
F77/350/B	£3796	€4366	Glass Door Black Painted	Left & 2 x Right	900	1350	500	357W	R290	310 Bottles	119.5

MODEL	PRICE £	PRICE €	DESCRIPTION
A A12/102	£126.50	€145.50	Chrome Wine Shelf
A A12/099	£117.30	€134.90	Chrome Wire Shelf
0* VS1017	£103	€119	De-gassed unit (only required to make suitable for Air Freight)

0* Factory fitted option please request at point of ordering

Mistral M135 Reduced Height - 800mm High

- Reduced 800mm height
- Stylish, flexible storage for up to 185 bottles
- Precise electronic temperature controller and auto defrost for perfectly-chilled drinks
- Energy-efficient forced air cooling for rapid temperature pull down
- Sleek stainless steel interior to enhance display
- Double-glazed lockable doors for enhanced security
- UK 3 pin plug allows users to simply plug in and switch on



Mistral M135 Reduced Height - 800mm high											
MODEL	PRICE £	PRICE €	DESCRIPTION	DOOR HINGING	H	W	D	POWER	GAS TYPE	CAPACITY	WT
F77/352	£3796	€4366	Glass Door Stainless Steel	Left & 2 x Right	800	1350	500	357W	R290	185 Bottles	122
F77/352/B	£3796	€4366	Glass Door Black Painted	Left & 2 x Right	800	1350	500	357W	R290	185 Bottles	122

MODEL	PRICE £	PRICE €	DESCRIPTION
A A12/102	£126.50	€145.50	Chrome Wine Shelf
A A12/099	£117.30	€134.90	Chrome Wire Shelf
0* VS1017	£103	€119	De-gassed unit (only required to make suitable for Air Freight)

0* Factory fitted option please request at point of ordering

Mistral TC60

Mistral TC60 - Full front glass

- Tall, space-saving storage for up to 272 bottles
- Reversible door
- Precise electronic temperature controller and auto defrost for perfectly-chilled drinks
- Energy-efficient forced air cooling for rapid temperature pull down
- Sleek stainless steel interior to enhance display
- Double-glazed doors
- UK 3 pin plug allows users to simply plug in and switch on
- Easy to remove and replace magnetic gaskets to facilitate cleaning



Mistral TC60 - Full front glass											
MODEL	PRICE £	PRICE €	DESCRIPTION	DOOR HINGING	H	W	D	POWER	GAS TYPE	CAPACITY	WT
F77/560	£2681	€3084	Glass Door Stainless Steel	Right	1850	600	500	759W	R290	272 Bottles	101
F77/560/B	£2681	€3084	Glass Door Black Painted	Right	1850	600	500	759W	R290	272 Bottles	101

MODEL	PRICE £	PRICE €	DESCRIPTION
A A12/082	£96.20	€110.65	Chrome Wine Shelf
A A12/041/Z2	£73.90	€85	Chrome Wire Shelf
0* VS1017	£103	€119	De-gassed unit (only required to make suitable for Air Freight)

0* Factory fitted option please request at point of ordering

Mistral TC60

Mistral TC60 – Full front glass with lockable door

- Tall, space-saving storage for up to 272 bottles
- Electronic temperature controller and auto defrost for perfectly-chilled drinks
- Energy-efficient forced air cooling for rapid temperature pull down
- Sleek stainless steel interior and LED lighting to enhance display
- Double-glazed lockable door for enhanced security
- UK 3 pin plug allows users to simply plug in and switch on
- Easy to remove and replace magnetic gaskets to facilitate cleaning



Mistral TC60 – Full front glass											
MODEL	PRICE £	PRICE €	DESCRIPTION	DOOR HINGING	H	W	D	POWER	GAS TYPE	CAPACITY	WT
F77/510	£2681	€3084	Glass Door Stainless Steel	Right	1850	600	500	759W	R290	272 Bottles	98
F77/510/B	£2681	€3084	Glass Door Black Painted	Right	1850	600	500	759W	R290	272 Bottles	98

MODEL	PRICE £	PRICE €	DESCRIPTION
A A12/082	£96.20	€110.65	Chrome Wine Shelf
A A12/041/Z2	£73.90	€85	Chrome Wire Shelf
0* VS1017	£103	€119	De-gassed unit (only required to make suitable for Air Freight)

0* Factory fitted option please request at point of ordering

2 YEAR
UK parts and labour warranty
Export parts warranty
on all IMC products



bm

BOTTLE COOLERS



With innovative design and reliable performance, BM bottle coolers are ideal for busy bars.

Featuring a top-loading door, BM bottle coolers are designed for underbar use. They allow bartenders quick access to drinks - providing a perfect storage solution at busy times, when service and stocking are paramount.

Available in two width variations, the BM range perfectly integrates with our Bartender® range of modular underbar systems. Energy-efficient, rapid cooling technology keeps drinks at the ideal serving temperature, whilst innovative shelving makes restocking swift and service quicker.

Ideally suited for...



Bars

Speed up service and generate customer satisfaction with great-tasting drinks. BM bottle coolers can help you deliver.



Restaurants

Enhance your customers' dining experience by serving high-quality drinks alongside delicious food. Keep your beverages at perfect temperature with BM.



Clubs

Need to serve a high volume of customers at the same time? With easy access and large storage capacities, BM can help you meet high demand through your busiest periods.

Serve perfectly-chilled drinks at speed with BM's top-loading bottle coolers.

Benefits at a glance

- Top-loading design for easy access
- Rapid chill for quick service
- Precise temperature control
- Energy efficient
- UK 3 pin plug
- Stylish exterior design for underbar systems

BM70 Top Loading Bottle Cooler

- Top loading design, with sliding cover, ensures fast and easy access to ice cold drinks.
- Rapid cooling so drinks can be served quickly.
- Stylish, vertical storage for 140 bottles.
- Interior lighting and shelving for enhanced display and storage.
- Stylish exterior to suit any commercial bar setting.
- UK 3 pin plug allows users to simply plug in and switch on.

Standard BM

Bartender

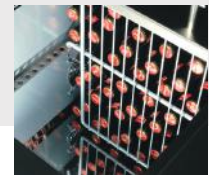
Bottle Basket

Divider Pack

BM70 Top Loading Bottle Cooler										
MODEL	PRICE £	PRICE €	DESCRIPTION	DOOR OPENING	H	W	D	POWER	CAPACITY	WT
F73/070/SS	£2652	€3050	BM with stainless steel lid	Top (sliding)	875	700	560	345W	140 Bottles	80
F73/071/SS	£2804	€3225	BM with glass lid	Top (sliding)	875	700	560	345W	140 Bottles	80
F73/072/SS	£2693	€3079	BM Bartender with stainless steel lid	Top (sliding)	950	700	560	345W	140 Bottles	80.5
F73/073/SS	£2841	€3268	BM Bartender with glass lid	Top (sliding)	950	700	560	345W	140 Bottles	80.5

MODEL	PRICE £	PRICE €	DESCRIPTION
A A12/089	£211	€243	Bottle Basket (each) - 4 required
A S73/004	£94	€109	Bottle opener and catcher
A S73/010	£88	€102	Divider pack
O* VS326	£267	€308	Speed Rail
O* VS321A	£168	€194	Internal light

O* Factory fitted option please request at point of ordering

Frostar



Enhance the taste and appearance of drinks with Frostar glass frosters.

Nothing beats a cocktail or beer served in an ice cold, frosted glass. Frostar frosters ensure rapid cooling and frosting of all type of glasses.

The perfect partner for any busy bar setting, Frostar frosters chill glasses to -17°C to keep drinks colder for longer, removing the need for ice, which

dilutes taste. This makes them the ideal choice for cocktails, beers and champagne. With a top-loading design, they enable staff to deliver high-quality, ice cold beverages quickly and efficiently.

Ideally suited for...



Bars

Want to keep customers coming back? Serve drinks that look fantastic and taste great. Frostar frosters deliver ice cold glasses that enhance visual appeal and keep beverages colder for longer.



Restaurants

Complement a strong food menu with sensational cocktails and ice cold beers. Make sure they are perfectly-presented and taste great with Frostar.



Clubs

Serve ice cold drinks with visual appeal with Frostar. With easy access, large storage capacities and rapid chill, keep the drinks flowing through your busiest periods.

Serve perfectly-presented, great-tasting drinks with speed with Frostar glass frosters.

Benefits at a glance

- Chills and frosts glasses to add visual appeal to drinks
- Rapid cooling to -17°C
- Precise temperature control
- Stylish exterior design
- Large capacity
- Quick and easy access to glasses

Frostar FR60

Frostar FR60 Top Loading Glass Froster

- Chills and frosts glasses, to enhance the taste and appearance of drinks
- Rapid chill to -17°C to keep drinks colder for longer
- Efficient design means up to 75 glasses can be chilled at the same time
- Top loading with sliding cover for quick and easy access
- Stylish stainless steel exterior to suit any commercial bar setting
- UK 3 pin plug - simply plug in and switch on



Frostar FR60 Top Loading Glass Froster											
MODEL	PRICE £	PRICE €	DESCRIPTION	DOOR HINGING	H	W	D	POWER	CAPACITY		WT
F49/400/SS	£3256	€3745	Stainless Steel Exterior	Top (Sliding)	900	600	620	623W	75 standard sized pint glasses		63.5
F49/400/BS	£3256	€3745	Black Exterior	Top (Sliding)	900	600	620	623W	75 standard sized pint glasses		63.5

MODEL	PRICE £	PRICE €	DESCRIPTION
A BA52/060	£225	€259	Speed Rail
A S49/017	£99	€114	Bottle opener and cap catcher



Vegetable Preparation

• Peelers • Chippers



Prepare a high volume of vegetables at speed with IMC's vegetable preparation solutions.

From peeling potatoes to washing shellfish and creating chips, we have a variety of vegetable preparation equipment to make life easier and speed up service.

Our range spans peelers and chippers, all of which have a compact, flexible design to suit kitchens of any size.

Ideally suited for...



Fish and chip shops

Fast service is crucial in fish and chip shops. IMC veg prep equipment delivers quick turnaround times on your potato peeling and chipping.



Pubs and restaurants

In busy kitchens, make food preparation quick and easy allowing you to focus your efforts on cooking and serving.

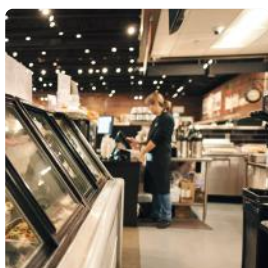

Fast food outlets

Take the stress out of busy periods with a high-volume, high-speed veg prep equipment to help you deliver food, fast.

Benefits at a glance

- Prepare vegetables at speed
- Simple and safe to operate
- Easy to clean
- Easy to maintain
- Robust construction
- Variety of sizes and outputs to suit the scale of your operation

Contents



VQ
PEELER

Potato Peelers

Save time and effort
with a VQ Peeler

Ideally suited for:

Restaurants, pubs, fish and chips shops, fast food outlets. Peel potatoes at speed within a small footprint.

Why choose a VQ Peeler?

- Simple and safe to operate
- Able to peel potatoes at speed
- Small footprint
- Easy to clean
- Robust construction

Find out
more on
page

i61



SP
PEELER

Potato Peelers

Amongst the fastest
potato peelers
on the market

Ideally suited for:

Restaurants, pubs, fish and chips shops, fast food outlets. For high-speed peeling and high output, invest in a SP Peeler

Why choose a SP Peeler?

- Simple and safe to operate
- Able to peel high volumes of potatoes fast
- Compact footprint
- Easy to maintain
- Long-lasting robust construction

Find out
more on
page

i63



MF
MULTIFUNCTIONAL
PEELER

Vegetable Peelers

Versatile and available in a
range of sizes, MF Peelers
produce perfectly-prepared
vegetables

Ideally suited for:

Restaurants and pubs. Multi-functional and efficient, the MF range saves operators valuable time

Why choose a MF Peeler?

- Easily adjustable timer
- Versatile
- Cost effective
- Simple and safe to operate
- Easy to maintain
- Built to last

Find out
more on
page

i65



IMChip
Potato Chippers

Potato Chippers

Produce 25kg of
chips per minute

Ideally suited for:

Fish and Chip Shops

Why choose an IMChip?

- Safe to operate
- High output - 25kg per minute
- Compact design
- Provides minimal waste
- Robustly engineered
- Easy to clean
- Easy to load

Find out
more on
page

i69

All prices are exclusive of VAT.

2
YEAR

UK parts
and labour
warranty

Export
parts
warranty

on all IMC products

UK

Goods are normally delivered free of charge to either the dealers' address or direct within 3 working days. If overnight and/or premium services are required charges will apply.

Export

Goods are priced ex works, export packaging is included.

☎ UK Tel: 01522 875500

☎ Export Tel: +44 1522 503250

✉ UK e-mail: sales@lincat.co.uk

✉ Export e-mail: export@lincat.co.uk



Peelers and Chippers

Multifunctional Peelers

	VQ3.5	VQ7	SP12	SP25	MF5	MF10	MF15	MF5L	MF10L	MF15L
PAGE	i62	i62	i64	i64	i66	i67	i67	i66	i67	i67
CAPACITY KG	3.5	7	12	25	5	10	15	5	10	15
OUTPUT KG PER HOUR	62.9	90	220	513.1	111	296	399	134	323	501
MOUNTING	Drainer or worktop	Drainer or worktop	Floor mounted	Floor mounted	Counter top	Floor standing	Floor standing	Counter top	Floor standing	Floor standing
PRODUCT USES										
PEELING POTATOES AND ROOT VEGETABLES	Potatoes only	Potatoes only	Potatoes only	Potatoes only	✓	✓	✓	✓	✓	✓
FINE FINISHING OF VEGETABLES	-	-	-	-	with optional knife plate	with optional knife plate	with optional knife plate	-	-	-
WASHING OF VEGETABLES	-	-	-	-	with optional vegetable washing plate	with optional vegetable washing plate	with optional vegetable washing plate	-	-	-
ONION/SHALLOT PEELING	-	-	-	-	with optional onion peeling plate	with optional onion peeling plate	with optional onion peeling plate	-	-	-
WASHING OF MUSSELS	-	-	-	-	with optional mussel washing plate	with optional mussel washing plate	with optional mussel washing plate	-	-	-
SPIN SALADS	-	-	-	-	with optional salad spinning basket	with optional salad spinning basket	with optional salad spinning basket	-	-	-
TIMER	Yes	Yes	Yes	Yes	Yes	Yes	Yes	Yes	Yes	Yes
PHASES AVAILABLE	Single or three	Single or three	Single or three	Single or three	Single	Single or three	Single or three	Single	Single or three	Single or three

Potato Chippers

	PC2	CS-C1
PAGE	i70	i71
HOPPER CAPACITY KG	12	12
OUTPUT KG PER MINUTE	25	25
MOUNTING	Drainer, worktop or optional stand	Drainer, worktop or optional stand
KNIFE BLOCK SIZES AVAILABLE	12mm, 14mm, 14mm x 14mm, 21mm x 17mm	12mm, 14mm, 14mm x 14mm, 21mm x 17mm
BUCKET SHELF ACCESSORY AVAILABLE	-	✓
POTATO TANK ACCESSORY AVAILABLE	-	✓
PHASES AVAILABLE	Single	Single

2
YEAR

UK parts and labour warranty
Export parts warranty

on all IMC products



VQ PEELER



In busy kitchens, staff need to be able to prepare potatoes quickly and efficiently. Save time and effort with a VQ peeler.

VQ peelers are compact and powerful, making them ideal for small to medium-sized kitchens where space is at a premium, but performance cannot be compromised.

Two sizes are available, which have the capacity to process vegetables in either 3.5kg or 7kg batches. The 3.5kg unit can process 62.9kg of potatoes per hour and the 7kg capacity unit - 90kg. VQ bench-top peelers have a small footprint and quiet running motor, enabling them to be used in the smallest of

kitchens. A heavy-duty belt and pulley system makes the peeler easy and safe to use.

Want to peel potatoes with speed? VQ peelers will produce high volumes from a small footprint.

Ideally suited for...



Fish and chip shops

Reduce customer waiting times by investing in speedy preparation equipment behind the scenes. A VQ peeler produces high volumes from a small footprint.



Pubs and restaurants

In busy kitchens, make food preparation quick and easy with a VQ peeler. Focus your efforts on cooking and serving.

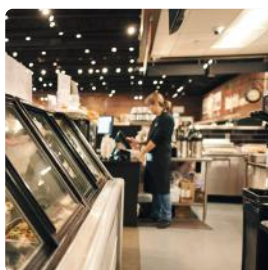

Fast food outlets

Serve food quickly by preparing potatoes ahead with a high output VQ peeler.

Benefits at a glance

- Able to peel potatoes at speed
- Small footprint
- Simple and safe to operate
- Easy to clean
- Robust construction



VQ 3.5 Potato Peeler

- Able to peel 62.9kg of vegetables per hour, in 3.5kg batches
- Small footprint and quiet operation, ideal for smaller kitchens
- Compact design for countertops and sink drainers
- Heavy-duty belt and pulley for simple and safe operation
- Self-draining cylinder with smooth profile for easy cleaning
- Long-lasting, rust-proof cast aluminium plate for effective peeling
- WRAS-approved Class A air-break and brass spray nozzle to prevent water escape



VQ 7 Potato Peeler

- Able to peel 90kg of vegetables per hour, in 7kg batches
- Small footprint and quiet operation, ideal for smaller kitchens
- Compact design for countertops and sink drainers
- Heavy-duty belt and pulley for simple and safe operation
- Self-draining cylinder with smooth profile for easy cleaning
- Long-lasting, rust-proof cast aluminium plate for effective peeling
- Class A air-break and brass spray nozzle to prevent water escape



VQ 3.5 Potato Peeler											
MODEL	PRICE £	PRICE €	DESCRIPTION	PHASE	H	W	D	POWER	CAPACITY	OUTPUT	WT
F72/200	£2168	€2494	VQ 3.5	1	425	653	367	0.18kW	3.5kg	63kg per hour	30.5

VQ 7 Potato Peeler											
MODEL	PRICE £	PRICE €	DESCRIPTION	PHASE	H	W	D	POWER	CAPACITY	OUTPUT	WT
F72/210	£2636	€3032	VQ 7	1	500	653	367	0.18kW	7kg	90kg per hour	31.5

Accessories

MODEL	PRICE £	PRICE €	DESCRIPTION
A E72/011	£130	€150	Sink Skip - Stainless steel, for use with bench mounted machines
A S72/220	£623	€717	Trolley - 890mm high
A S72/221	£507	€584	Pedestal - Lifts potato discharge height in steps to 750, 800, 850, 900 & 950mm
A S72/023	£383	€441	Waste Ejector - 2" BSP
A A29/003	£19.90	€22.90	Lid Retaining Strap - For marine use



E72/011



S72/220



S72/221

SP PEELER



SP peelers are amongst the fastest potato peelers on the market, helping you deliver through the busiest periods.

SP peelers make fresh potatoes as quick and easy to use as pre-prepared products. Their compact design ensures that even the 25kg model takes up a minimum amount of floor space. They are also safe and simple to use, and minimise staff labour.

Not only are these peelers the easiest and quickest to clean, they're also built to last, with exceptional durability and outstanding reliability. With a choice of pedestal heights, capacities and outputs, there's an SP Peeler to suit your working

environment. The thickly-gritted, non-rusting cast aluminium peeler plate is robust and offers a long service life. The hygienic brushed stainless steel finish is easy to wash, whilst the lid and peeling plate are quick and easy to remove for cleaning.

For high-speed peeling and high output, invest in a space-saving SP peeler.

Ideally suited for...



Fish and chip shops

Take the stress away from peak periods with an SP peeler - prepare high volumes of potatoes for chipping.



Pubs and restaurants

Keep up with demand at busy times with an SP peeler. Peel large quantities of potatoes in super quick time.

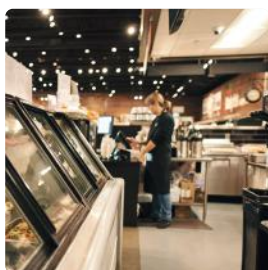

Fast food outlets

Where speed is crucial, accelerate your food preparation process with an SP potato peeler.

Benefits at a glance

- Able to peel high volumes of potatoes, fast
- Compact footprint
- Safe and simple to operate
- Long-lasting, robust construction
- Easy to maintain

SP12 Potato Peelers

- Able to peel 12kg of potatoes in 2 minutes - up to 220kg per hour
- Low pedestal version, the perfect height to empty into a sink
- Upright design with small footprint, ideal for medium and large operations
- Lubricated, heavy-duty gearbox makes peeling operation smooth and reliable
- Dual position waste outlets and smooth cylinder base for quick, easy cleaning
- Long-lasting, rust-proof plate and reversible liners for effective peeling
- WRAS-approved Class A air-break and brass spray nozzle to prevent water escape



Accessories

MODEL	PRICE £	PRICE €	DESCRIPTION
A S58/568	£543	€625	Integral Filter Basket
A S58/570	£292	€336	Waste Ejector (2" BSP)
A S58/569	£535	€616	Interceptor Tank (2" BSP)
A A29/003	£19.90	€22.90	Lid Retaining Strap



SP12H Potato Peelers

- Able to peel 12kg of potatoes in 2 minutes - up to 220kg per hour
- High pedestal version, the perfect height to empty into a mobile chip hopper
- Upright design with small footprint, ideal for medium and large operations.
- Lubricated, heavy-duty gearbox makes peeling operation smooth and reliable
- Dual position waste outlets and smooth cylinder base for quick, easy cleaning
- Long-lasting, rust-proof plate and reversible liners for effective peeling
- WRAS-approved Class A air-break and brass spray nozzle to prevent water escape



SP12 Potato Peeler											
MODEL	PRICE £	PRICE €	DESCRIPTION	PHASE	H	W	D	POWER	CAPACITY	OUTPUT	WT
F58/900	£4627	€5322	SP12 Low Pedestal	1	1109	530	624	370W	12kg	220kg per hour	58.5
*F58/901	£4472	€5143	SP12 Low Pedestal	3	1109	530	624	370W	12kg	220kg per hour	58.5

SP12H Potato Peeler											
MODEL	PRICE £	PRICE €	DESCRIPTION	PHASE	H	W	D	POWER	CAPACITY	OUTPUT	WT
F58/902	£4709	€5416	SP12H High Pedestal	1	1388	530	624	370W	12kg	220kg per hour	60.5
*F58/903	£4558	€5242	SP12H High Pedestal	3	1388	530	624	370W	12kg	220kg per hour	60.5

SP25 Potato Peelers

- 2 minutes to peel a 25 kilo bag - up to 513kg per hour
- Low pedestal version, the perfect height to empty into a sink
- Upright design with small footprint, ideal for medium and large operations
- Lubricated, heavy-duty gearbox makes peeling operation smooth and reliable
- Dual position waste outlets and smooth cylinder base for quick, easy cleaning
- Long-lasting, rust-proof plate and reversible liners for effective peeling
- Class A air-break and brass spray nozzle to prevent water escape



Accessories

MODEL	PRICE £	PRICE €	DESCRIPTION
A S58/568	£543	€625	Integral Filter Basket
A S58/570	£292	€336	Waste Ejector (2" BSP)
A S58/569	£535	€616	Interceptor Tank (2" BSP)
A A29/003	£19.90	€22.90	Lid Retaining Strap

SP25H Potato Peelers

- 2 minutes to peel a 25 kilo bag - up to 513kg per hour
- High pedestal version, the perfect height to empty into a mobile chip hopper
- Upright design with small footprint, ideal for medium and large operations
- Lubricated, heavy-duty gearbox makes peeling operation smooth and reliable
- Dual position waste outlets and smooth cylinder base for quick, easy cleaning
- Long-lasting, rust-proof plate and reversible liners for effective peeling
- Class A air-break and brass spray nozzle to prevent water escape



SP25 Potato Peeler											
MODEL	PRICE £	PRICE €	DESCRIPTION	PHASE	H	W	D	POWER	CAPACITY	OUTPUT	WT
F58/910	£5702	€6558	SP25 Low Pedestal	1	1057	602	727	750W	25kg	513kg per hour	78
*F58/911	£5505	€6331	SP25 Low Pedestal	3	1057	602	727	750W	25kg	513kg per hour	78

SP25H Potato Peeler											
MODEL	PRICE £	PRICE €	DESCRIPTION	PHASE	H	W	D	POWER	CAPACITY	OUTPUT	WT
F58/912	£5782	€6650	SP25H High Pedestal	1	1357	603	728	750W	25kg	513kg per hour	80.5
*F58/913	£5586	€6424	SP25H High Pedestal	3	1357	603	728	750W	25kg	513kg per hour	80.5

MF

MULTI-FUNCTIONAL
PEELER



Versatile and available in a range of sizes, MF peelers produce perfectly-prepared vegetables.

Offering a great deal more than just vegetable peeling, our MF models are essential all-rounders for any commercial kitchen. Designed to peel a full load of potatoes or other vegetables in little more than a minute, these versatile, highly-efficient units free up time for other preparation tasks.

The MF Range is available with a wide range of plates, each designed to perform a different function.

Practical features include a viewing panel to monitor progress, an interlocking lid for safe operation and an adjustable timer for repeatable, consistent results. In addition to the standard long-life peeling plate, options include a knife plate to give a smoother look to potatoes and carrots, whilst onions and shallots have their own special plate and liners. There's a washing plate for use with summer vegetables, as well as a plate for cleaning mussels and a salad spinning basket.

Ideally suited for...



Fish and chip shops

Want to save time on food preparation so you can serve more customers? A multi-functional MF peeler is the perfect partner for your kitchen.



Pubs and restaurants

Keep customers happy with high-quality food and great service. Speed up food preparation time with an MF peeler.



Fast food outlets

Satisfy customers with speedy service. Accelerate your food preparation process with an MF peeler.

Multi-functional and efficient, the MF range saves operators valuable time.

Benefits at a glance

- Versatile
- Cost effective
- Energy efficient
- Safe and simple to operate
- Easily adjustable timer
- Easy to maintain
- Built to last



MF5 Multifunctional Peeler

- Able to peel up to 111kg of vegetables per hour - in 5kg batches
- Versatile - can be used to peel and wash veg and mussels, and spin salad.
- Interlocking lid ensures safe operation
- Perspex viewing pane allows you to monitor the peeling progress
- Adjustable timer ensures accurate, repeatable peeling times
- Modular construction facilitates easy maintenance
- Thicker peeling plate delivers longer operating life



MF5L Multifunctional Peeler

- Able to peel up to 134kg of vegetables per hour - in 5kg batches
- With carborundum liner to reduce peeling time even further
- Interlocking lid ensures safe operation
- Perspex viewing pane allows you to monitor the peeling progress
- Adjustable timer ensures accurate, repeatable peeling times
- Modular construction facilitates easy maintenance
- Thicker peeling plate delivers longer operating life



MF5 Multifunctional Peeler											
MODEL	PRICE £	PRICE €	DESCRIPTION	PHASE	H	W	D	POWER	CAPACITY	OUTPUT	WT
*F59/500	£3084	€3547	MF5	1	634	366	519	0.25KW	5kg	111kg per hour	32

MF5L Multifunctional Peeler											
MODEL	PRICE £	PRICE €	DESCRIPTION	PHASE	H	W	D	POWER	CAPACITY	OUTPUT	WT
*F59/500/L	£3120	€3588	MF5L with Carborundum Liner	1	634	366	519	0.25KW	5kg	134kg per hour	33.5

Accessories

MODEL	PRICE £	PRICE €	DESCRIPTION
A S59/163	£235	€271	Additional Carborundum Peeling Plate
A S59/167	£348	€401	Knife Peeling Plate
A S59/172	£411	€473	Vegetable Washing Plate
A S59/174	£280	€322	Mussel Washing Plate
A S59/169	£325	€374	Salad Spinning Basket
A S59/245	£894	€1029	Stand and Filter Basket

Accessories

MODEL	PRICE £	PRICE €	DESCRIPTION
A S59/163	£235	€271	Additional Carborundum Peeling Plate
A S59/245	£894	€1029	Stand and Filter Basket



S59/245

MF10 Multifunctional Peeler

- Able to peel up to 296kg of vegetables per hour - in 10kg batches
- Versatile - can be used to peel and wash veg and mussels, and spin salad
- Interlocking lid ensures safe operation
- Perspex viewing pane allows you to monitor the peeling progress
- Adjustable timer ensures accurate, repeatable peeling times
- Modular construction facilitates easy maintenance
- Thicker peeling plate delivers longer operating life



MF10L Multifunctional Peeler

- Able to peel up to 323kg of vegetables per hour - in 10kg batches
- With carborundum liner to reduce peeling times even further
- Interlocking lid ensures safe operation
- Perspex viewing pane allows you to monitor the peeling progress
- Adjustable timer ensures accurate, repeatable peeling times
- Modular construction facilitates easy maintenance
- Thicker peeling plate delivers longer operating life



MF10 Multifunctional Peeler											
MODEL	PRICE £	PRICE €	DESCRIPTION	PHASE	H	W	D	POWER	CAPACITY	OUTPUT	WT
*F59/510	£4872	€5603	MF10	1	1105	481	633	370W	10kg	296kg per hour	59
*F59/511	£4696	€5401	MF10	3	1105	481	633	370W	10kg	296kg per hour	59

MF10L Multifunctional Peeler											
MODEL	PRICE £	PRICE €	DESCRIPTION	PHASE	H	W	D	POWER	CAPACITY	OUTPUT	WT
*F59/510/L	£4908	€5645	MF10L with Carborundum Liner	1	1105	481	633	370W	10kg	323kg per hour	60.5
*F59/511/L	£4733	€5443	MF10L with Carborundum Liner	3	1105	481	633	370W	10kg	323kg per hour	60.5

MF15 Multifunctional Peeler

- Able to peel up to 399kg of vegetables per hour - in 15kg batches
- Versatile - can be used to peel and wash veg and mussels, and spin salad
- Interlocking lid ensures safe operation
- Perspex viewing pane allows you to monitor the peeling progress
- Adjustable timer ensures accurate, repeatable peeling times
- Modular construction facilitates easy maintenance
- Thicker peeling plate delivers longer operating life



MF15L Multifunctional Peeler

- Able to peel up to 501kg of vegetables per hour - in 15kg batches
- With carborundum liner to reduce peeling times even further
- Interlocking lid ensures safe operation
- Perspex viewing pane allows you to monitor the peeling progress
- Adjustable timer ensures accurate, repeatable peeling times
- Modular construction facilitates easy maintenance
- Thicker peeling plate delivers longer operating life



MF15 Multifunctional Peeler											
MODEL	PRICE £	PRICE €	DESCRIPTION	PHASE	H	W	D	POWER	CAPACITY	OUTPUT	WT
*F59/520	£5505	€6331	MF15	1	1177	481	635	730W	15kg	399kg per hour	69.1
*F59/521	£5330	€6130	MF15	3	1177	481	635	600W	15kg	399kg per hour	69.1

MF15L Multifunctional Peeler											
MODEL	PRICE £	PRICE €	DESCRIPTION	PHASE	H	W	D	POWER	CAPACITY	OUTPUT	WT
*F59/520/L	£5540	€6371	MF15L with Carborundum Liner	1	1177	481	635	730W	15kg	510kg per hour	62.5
*F59/521/L	£5365	€6170	MF15L with Carborundum Liner	3	1177	481	635	600W	15kg	510kg per hour	62.5

Accessories

MODEL	PRICE £	PRICE €	DESCRIPTION
A S59/164	£300	€345	Additional Carborundum Peeling Plate
A S59/170	£356	€410	MF10 Salad Spinning Basket
A S59/171	£379	€436	MF15 Salad Spinning Basket
A S59/168	£524	€603	Knife Peeling Plate
A S59/173	£491	€565	Vegetable Washing Plate
A S59/175	£346	€398	Mussel Washing Plate
A E72/011	£130	€150	Potato Peeler Sink Skip
A S58/062	£39	€45	Potato Peeler Inlet Hose Kit

Accessories

MODEL	PRICE £	PRICE €	DESCRIPTION
A S59/164	£300	€345	Additional Carborundum Peeling Plate
A E72/011	£130	€150	Potato Peeler Sink Skip
A S58/062	£39	€45	Potato Peeler Inlet Hose Kit



MF10 Multifunctional Peeler with Onion Plate

- Able to peel up to 144kg of onions per hour - in 10kg batches
- Smooth stainless steel waste outlet prevents blockages and build-up of peelings
- Interlocking lid ensures safe operation
- Perspex viewing pane allows you to monitor the peeling progress
- Adjustable timer ensures accurate, repeatable peeling times
- Modular construction facilitates easy maintenance
- Thicker peeling plate delivers longer operating life



MF15 Multifunctional Peeler with Onion Plate

- Able to peel up to 202kg of onions per hour - in 15kg batches
- Smooth stainless steel waste outlet prevents blockages and build-up of peelings
- Interlocking lid ensures safe operation
- Perspex viewing pane allows you to monitor the peeling progress
- Adjustable timer ensures accurate, repeatable peeling times
- Modular construction facilitates easy maintenance
- Thicker peeling plate delivers longer operating life



MF10 Multifunctional Peeler with Onion Plate											
MODEL	PRICE £	PRICE €	DESCRIPTION	PHASE	H	W	D	POWER	CAPACITY	OUTPUT	WT
*F59/710	£5068	€5829	MF10 with Onion Plate	1	1105	481	629	730W	10kg	144kg per hour	60.5
*F59/720	£4843	€5570	MF10 with Onion Plate	3	1105	481	629	600W	10kg	144kg+g per hour	60.5

MF15 Multifunctional Peeler with Onion Plate											
MODEL	PRICE £	PRICE €	DESCRIPTION	PHASE	H	W	D	POWER	CAPACITY	OUTPUT	WT
*F59/730	£5698	€6553	MF15 with Onion Plate	1	1171	481	629	730W	15kg	202kg per hour	62.5
*F59/740	£5524	€6353	MF15 with Onion Plate	3	1171	481	629	600W	15kg	202kg per hour	62.5

Accessories for MF10/MF15 with Onion Plate

MODEL	PRICE £	PRICE €	DESCRIPTION
A S59/166	£278	€320	Additional Onion Peeling Plate
A S58/062	£39	€45	Inlet Hose Kit



IMChip

Potato Chippers



Produce 25kg of chips per minute with the CS-C1 or PC2 chipper.

These flexible units can be mounted on a drainer, worktop or stand, making it the ideal solution for kitchens of any size. Screw-down, rigid knife blocks in four different sizes, provide the perfect cut every time, with minimal waste.

To cut chips to the perfect size and shape, IMChip chippers are supplied with a knife block in a size of your choice: 12mm, 14mm, 17mm by 14mm, or 21mm by 17mm. Its extra large hopper, with safety interlock makes for quick and easy loading, meaning potatoes can be loaded quickly and easily, so that kitchens can keep up with demand at busy times.

Ideally suited for...



Fish and chip shops

Take busy periods in your stride with an IMChip chipper, which can produce 25kg of perfectly chipped potatoes a minute.



Pubs and restaurants

Enhance the main event by serving perfectly-cut chips on the side. The IMChip chippers produce high volume, fast, to speed up serving times.

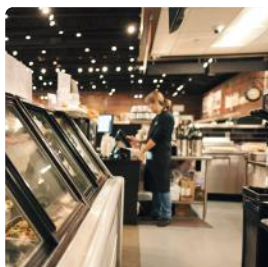

Fast food outlets

Service speed is crucial in a fast food restaurant. Shorten waiting times with an IMChip chipper, which can produce 25kg of chips in just one minute.

Need to produce a high volume of chips quickly? The IMChip chippers deliver 25kg a minute, saving kitchens valuable time.

Benefits at a glance

- High output - 25kg per minute
- Compact design
- Provides minimal waste
- Safe to operate
- Robustly engineered
- Easy to clean
- Easy to load



PC2 Potato Chipper

- Able to produce 25kg of chips per minute
- Compact design, with flexible mounting options, to suit kitchens of any size
- Large-capacity 12kg hopper allows quick and easy loading
- One-piece knife block design for quick and safe cutting, with minimal waste
- Supplied with knife block - 12mm, 14mm, 17mm, or 21mm sizes available
- Engineered using heavy-gauge stainless steel, for longevity and easy cleaning
- UK 3 pin plug allows users to simply plug in and switch on
- Please specify a knife block option at point of ordering chipper



PC2 Potato Chipper											
MODEL	PRICE £	PRICE €	DESCRIPTION	PHASE	H	W	D	POWER	CAPACITY	OUTPUT	WT
F61/220	£4369	€5025	PC2 Potato Chipper	1	550	370	603	340W	15kg	25kg per minute	46.5

Knife block options

Please specify at point of ordering chipper

MODEL	PRICE £	PRICE €	DESCRIPTION
0* S61/135	£347	€400	Knife block 12mm x 12mm
0* S61/114	£347	€400	Knife block 14mm x 14mm
0* S61/115	£347	€400	Knife block 17 x 14mm
0* S61/182	£347	€400	Knife block 21 x 17mm

Spares and Accessories

MODEL	PRICE £	PRICE €	DESCRIPTION
A S61/140	£332	€382	Chipper Stand
S S61/134	£131.40	€151.15	Replacement blades for 12mm x 12mm knife block (6 blades)
S S61/129	£95.05	€109.35	Replacement blades for 14mm x 14mm knife block (5 blades)
S S61/128	£95.05	€109.35	Replacement blades for 17mm x 14mm knife block (4 blades)
S S61/183	£95.05	€109.35	Replacement blades for 21mm x 17mm knife block (4 blades)



Knife Block



Chipper Stand

CS-C1 Potato Chipper

- Able to produce 25kg of chips per minute
- Compact design, with flexible mounting options, to suit kitchens of any size
- Screw-down, rigid knife block provides perfect cut every time with little waste
- Supplied with knife block - 12mm, 14mm, 17mm, or 21mm sizes available
- Extra large hopper, with safety interlock, allows quick and easy loading
- Safe, single blade design for quick removal and replacement
- Engineered using heavy-gauge stainless steel, for longevity and easy cleaning
- UK 3 pin plug allows users to simply plug in and switch on
- Please specify a knife block option at point of ordering chippers



CS-C1 Potato Chipper											
MODEL	PRICE £	PRICE €	DESCRIPTION	PHASE	H	W	D	POWER	CAPACITY	OUTPUT	WT
F61/301	£4106	€4722	CS-C1 Potato Chipper	1	550	400	692	340W	15kg	25kg per minute	46.5

Knife block options

Please specify at point of ordering chipper

MODEL	PRICE £	PRICE €	DESCRIPTION
0* S61/145	£297	€342	Knife block 12mm x 12mm
0* S61/151	£297	€342	Knife block 14mm x 14mm
0* S61/144	£297	€342	Knife block 17 x 14mm
0* S61/184	£297	€342	Knife block 21 x 17mm

Spares and Accessories

MODEL	PRICE £	PRICE €	DESCRIPTION
S S61/134	£131.40	€151.15	Replacement blades for 12mm x 12mm knife block (6 blades)
S S61/129	£95.05	€109.35	Replacement blades for 14mm x 14mm knife block (5 blades)
S S61/128	£95.05	€109.35	Replacement blades for 17mm x 14mm knife block (4 blades)
S S61/183	£95.05	€109.35	Replacement blades for 21mm x 17mm knife block (4 blades)
A S61/142	£218	€251	Bucket (solid)
A S61/143	£218	€251	Bucket (perforated)
A S61/141	£140	€161	Bucket shelf
A S61/140	£332	€382	Chipper Stand
A S61/171	£1866	€2146	Potato tank with eyeing tray - Low (approx 10 bags)
A S61/205	£2100	€2415	Mobile Potato tank with eyeing tray - Low (approx 10 bags)
A S61/170	£1866	€2146	Potato tank with eyeing tray (approx 10 bags)
A S61/204	£2100	€2415	Mobile Potato tank with eyeing tray (approx 10 bags)
A S61/167	£1966	€2261	Potato tank with eyeing tray (approx 12 bags)
A S61/203	£2196	€2526	Mobile Potato tank with eyeing tray (approx 12 bags)
A S61/169	£2222	€2556	Potato tank with eyeing tray (approx 14 bags)
A S61/202	£2293	€2637	Mobile Potato tank with eyeing tray (approx 14 bags)
A S61/166	£2140	€2461	Potato tank with eyeing tray (approx 18 bags)
A S61/201	£2371	€2727	Mobile Potato tank with eyeing tray (approx 18 bags)



Knife Block



Bucket Shelf



Chipper Stand

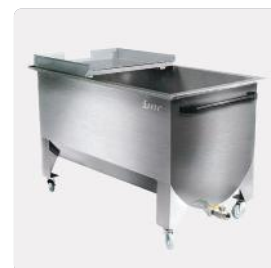

Potato Tank with eyeing tray





Waste Management

• Food Waste Disposers • Waste Compactors



Create a cleaner, safer working environment and save time and money, by investing in efficient waste management equipment.

From leftovers on a plate, to high volumes of packaging, we have a wide variety of solutions to handle both food and dry waste. Our range of equipment spans waste disposers and compactors, to suit operations large and small.

Waste disposers provide a fast and efficient way to process food waste,

to create a cleaner, safer working environment and save on waste handling time.

Waste compactors cut waste volumes, which saves valuable handling time and reduces collection costs. They help organisations improve recycling rates and save on storage space.

Ideally suited for...



Pubs & Bars

Make the management of waste quick and easy - saving valuable staff time that can be spent serving customers.



Nursing homes

Meet the best hygiene practices.

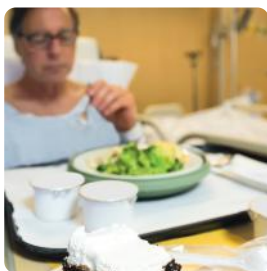

Hospitals

Handle high volumes of waste quickly, efficiently and cost-effectively.



Factories

Boost your recycling efforts and become greener by compacting your waste.

Make the management of waste quick and easy and saving valuable staff time.

Benefits at a glance

- Compact and efficient
- Remove waste quickly
- Safe and easy operation
- Reduces costs, saves time



Contents



WASTE STATION

Food Waste Management

Reducing the volume of food waste by up to 80% and the mass by up to 60%

Ideally suited for:

Restaurants, hospitals, care homes, schools, make the management of waste quick and easy.

Why choose WasteStation?

- Waste removal savings - reduce waste collection costs by up to 80%
- Reduce your carbon footprint - Lower frequency of vehicles collecting your waste
- Storage Savings - by reducing on site waste storage facility requirements
- Labour Savings - reduce staff time processing and managing waste
- Energy Savings - low operating costs and minimal use of kitchen floor space.
- Maximise Kitchen Hygiene
- Increases quality of dry recycling due to less contamination from food

Find out more on page

i75



Vulture

Compact Food Waste Disposers

Create a clean, safe working environment and save time and money

Ideally suited for:

Vulture food waste disposers provide a fast and efficient way to process food waste, making it perfect for a range of applications, such as pubs, restaurants, nursing homes and hospitals.

Why choose Vulture?

- Compact and efficient
- Remove waste quickly
- Safe and easy operation
- Reduces costs, saves time

Find out more on page

i81



IP COMPACTOR

Waste Compactors

Cut waste volumes by up to 80%

Ideally suited for:

Whether you are a small hotel, restaurant, large school, hospital, shop, factory or ship, handle high volumes of dry waste quickly, efficiently and cost-effectively with an IP compactor.

Why choose IP Compactor?

- Cut your waste volumes by up to 80%
- Cut your waste collection costs
- Designed to compress all dry waste, including cardboard, tins, plastic and paper
- Tough, reliable and simple to use
- Quiet, safe and energy efficient
- Avoid heavy lifting, models with trolley or bin to wheel to disposal point
- Minimise the area needed for waste storage

Find out more on page

i89

2 YEAR

UK parts and labour warranty
Export parts warranty
on all IMC products

All prices are exclusive of VAT.

UK
Goods are normally delivered free of charge to either the dealers' address or direct within 3 working days. If overnight and/or premium services are required charges will apply.

Export
Goods are priced ex works, export packaging is included.

☎ UK Tel: 01522 875500

☎ Export Tel: +44 1522 503250

✉ UK e-mail: sales@lincat.co.uk

✉ Export e-mail: export@lincat.co.uk



WASTE STATION



Food waste typically represents around 40% of total commercial catering waste. It is difficult and costly to process and dispose of this efficiently.

Of this 40%, approximately 77% is liquid. WasteStation grinds the food waste into fine particles, which are fed directly into a built-in dewatering system, or for where space in the kitchen is limited, a remote dewatering system. Through centrifugal action, excess liquid is forced out.

The resulting solid fraction of the food waste is collected in small, easily managed, lidded bins, ready for onward processing.

Ideally suited for...



Restaurants

Make the management of waste quick and easy - saving valuable staff time that can be spent serving customers.



Care homes

Meet the best hygiene practices

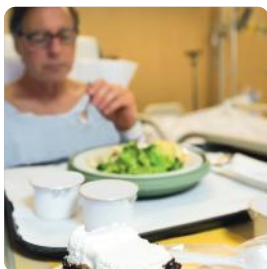

Hospitals

Waste Station can handle high volumes of waste quickly, efficiently and cost-effectively.



Schools

With the WasteStation and WasteStation compact, we have a waste solution whatever the size of your school.

WasteStation reduces the volume of food waste by up to 80% and the mass by up to 60%

Benefits at a glance

- Waste removal savings - reduce waste collection costs by up to 80%
- Reduce your carbon footprint - Lower frequency of vehicles collecting your waste
- Storage Savings - by reducing on site waste storage facility requirements
- Labour Savings - reduce staff time processing and managing waste
- Energy Savings - low operating costs and minimal use of kitchen floor space.
- Maximise Kitchen Hygiene
- Increases quality of dry recycling due to less contamination from food



Food Waste Management



WasteStation

Page i79

Reliable and efficient, the WasteStation allows staff to quickly reduce the volume of food waste, making it ideal for a wide range of applications including hotels, restaurants, hospitals, canteens, and prisons processing up to 1450 covers per hour.

The macerator and dewaterer reduce the waste volume by up to 80%, reducing on site storage as well as waste collection costs.

WasteStation Compact 2

Page i79

Compact and space saving the WasteStation Compact offers establishments of up to 850 covers the same benefits as the WasteStation for plate and medium food waste, all within a 40% smaller footprint. Single or 3 phase version available.

Ideal for small to medium size hotels, restaurants, nursing homes and schools.





WastePro II

Page i80

The flexibility of WastePro II provides a cost effective system for commercial and institutional kitchens. Connected to a suitable existing IMC or alternative brand waste disposer in either a standalone or trough configuration WastePro II removes excess liquid from macerated food waste through centrifugal action, reducing the volume of waste by up to 80%.

Food Waste Disposers			
	WasteStation Compact 2	WasteStation	WastePro II
PAGE	i79	i79	i80
PRODUCT CODE	F79/701 (1ph) F79/703 (3ph)	F79/010 (3ph)	F78/020 (Right hand discharge) F78/030 (Left hand discharge)
COVERS	850	1450	1850
WASTE PER HOUR (KG)	400	700	900
LOADING	Bucket Feed	Bucket Feed	N/A
HOPPER CAPACITY (LITRES)	N/A	N/A	N/A
MACERATOR	Within unit	Within unit	N/A
DEWATERER	Within unit	Within unit	Within unit
PUMPING DISTANCE (METRES)	N/A	N/A	55
SOFT WASTE (PLATE WASTE, VEG PEELINGS, MEAT AND FISH SCRAPS)	✓	✓	N/A
MEDIUM WASTE (SMALL PORK BONE AND CHICKEN BONES, VEGETABLES AND FRUIT)	✓	✓	N/A
TOUGH WASTE (ALL RED MEAT BONES, CAULIFLOWER STALKS AND FISH SKINS)	X	✓	N/A

2
YEAR

UK parts
and labour
warranty

Export
parts
warranty

on all IMC products

WASTE STATION

80% reduction in waste - for every 5 wheelie bins you would normally fill with food waste, fill just 1!



Food waste typically represents around 40% of total commercial catering waste. Of this 40%, approximately 77% is liquid. WasteStation grinds the food waste into fine particles, these particles feed directly into the built-in dewatering system. Through centrifugal action, the WasteStation forces out the excess liquid from the macerated waste.

This "grey water" is fed directly to drain, the resulting solid fraction of the food waste is collected in small, easily managed, lidded bins, ready for onward processing.

Transport Savings

- Reduce waste collection costs by up to 80%.

Storage Savings

- By reducing the waste volume, on site waste storage facility requirements are also reduced.

Labour Savings

- Reduce staff time processing and managing waste. No loading schedule, process waste as and when you need to.
- Self-cleaning operation - WasteStation can undertake a thorough clean ensuring the whole system is free of food and grease.
- Self-emptying - this eliminates the need for staff to empty the auger assembly reducing labour. The intelligent electronic sensor, detects when the bin is full.
- Visual control panel - kitchens are a noisy environment, WasteStation incorporates a simple LED display to allow monitoring of the equipment during operation.

Energy Savings

- Compact design and short processing times ensure low operating costs and minimal use of kitchen floor space.

Maximising Kitchen Hygiene

- Self-rinse system - following each operation the machine undertakes a quick rinse cycle preventing any build-up of food and the associated odour.
- Fully enclosed system - prevents food entering the unit, keeping the machine clean and free of waste and reducing operational noise.

Ideally suited for

There is a WasteStation to suit the scale of your operation from WasteStation Compact 2 for organisations producing up to 400 kg waste per hour, 850 covers to the larger WasteStation for organisations producing up to 700 kg waste per hour, 1450 covers.

- Hotels
- Restaurants
- Supermarkets
- Schools
- Hospitals
- Canteens
- Refectories
- Prisons and barracks



WasteStation Compact 2



Introducing the next generation of the Waststation Compact

At 900mm high, 600mm wide and 700mm deep the Waststation Compact 2 is barely any larger than a standard undercounter fridge!

Ideal for small to medium size hotels, restaurants, nursing homes and schools.

WasteStation and WasteStation Compact 2											
MODEL	PRICE £	PRICE €	DESCRIPTION	POWER	PHASE	H	W	D	WASTE PER HR	COVERS PER HR	WT
*F79/701	£17,025	€19,579	WasteStation Compact 2	2.95kW	1	1044	600	700	400 kg	850	182
*F79/703	£17,025	€19,579	WasteStation Compact 2	2.95kW	3	1044	600	700	400 kg	850	182

Accessories, Spares and Options for WasteStation Compact 2

MODEL	PRICE £	PRICE €	DESCRIPTION
A K12/469	£70	€81	Caddy
S A13/159	£27.15	€31.25	Scraper

WasteStation

Reliable and efficient the Waststation allows staff to quickly reduce the volume of food waste making it ideal for a wide range of applications including hotels, canteens and prisons



WasteStation and WasteStation Compact 2											
MODEL	PRICE £	PRICE €	DESCRIPTION	POWER	PHASE	H	W	D	WASTE PER HR	COVERS PER HR	WT
*F79/010	£25,981	€29,879	WasteStation	4.1kW	3	1000	900	700	700 kg	1450	280
e *F79/100	£25,710	€29,567	WasteStation without air break	4.1kW	3	1000	900	700	700 kg	1450	280

Accessories, Spares and Options for WasteStation

MODEL	PRICE £	PRICE €	DESCRIPTION
A K12/357	£70	€81	Caddy
S A13/125	£63.85	€73.45	Scraper
0 VS605	£503	€579	Silver Saver Baffle

2 YEAR UK parts and labour warranty | Export parts warranty
on all IMC products

WastePro II

Connected to a suitable existing IMC or alternative brand waster disposer in either a standalone or trough configuration WastePro II removes excess liquid from macerated food waste through centrifugal action, reducing the volume of waste by up to 80%.

WastePro II is ideal in instances where food waste can no longer be disposed of via mains drainage, either due to technical restrictions or legal regulations. The grey water is dispensed direct to drain whilst the solid waste is captured in a lidded bin for subsequent onward processing. The flexibility of WastePro II provides a cost effective system for commercial and institutional kitchens.



Features and Benefits

No need to replace existing waste disposer

- Simply connect to existing waster disposer in either a standalone or trough configuration
- Minimal disruption to kitchen

Ensures compliance with technical and legal restrictions

- Where food waste cannot be disposed of via mains drainage

Ideally suited for

- Kitchens with an existing waste disposer
- Where food waste cannot be disposed of via mains drainage either due to technical restrictions or legal regulations
- Cost-effective system for almost all commercial and institutional organisations

WasteStation CR												
MODEL	PRICE £	PRICE €	DESCRIPTION	POWER	PHASE	H	W	D	WASTE PER HR	COVERS PER HR	WT	
*F78/020	£14,750	€16,963	WastePro II Right hand discharge	1.1kW	3	980	450	825	900 kg	1950	130	
*F78/030	£14,750	€16,963	WastePro II Left hand discharge	1.1kW	3	980	450	825	900 kg	1950	130	

Accessories

MODEL	PRICE £	PRICE €	DESCRIPTION
A K12/357	£70	€81	Waste Caddy

* Please refer to page i97 for electricity supply requirements



Create a cleaner, safer working environment and save time and money, by investing in efficient waste disposal equipment.

With a compact design, 700 series waste disposers offer an excellent solution for the disposal of medium waste - small pork and chicken bones, vegetables and fruit.

800 series, 04 and 04X series food waste disposers offer quick and easy removal of high quantities of tough food waste, including red meat bones, cauliflower stalks and fish skins.

Ideally suited for...

Vulture food waste disposers provide a fast and efficient way to process food waste, making it perfect for a range of applications, such as:



Pubs & bars

Make the management of waste quick and easy - saving valuable staff time that can be spent serving customers.



Nursing homes

Meet the best hygiene practices

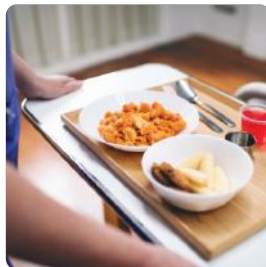

Hospitals

Handle high volumes of waste quickly, efficiently and cost-effectively.

Waste disposers provide a fast and efficient way to process food waste, to create a cleaner, safer working environment and save on waste handling time.

Benefits at a glance

- Compact and efficient
- Remove waste quickly
- Safe and easy operation
- Reduces costs, saves time



Vulture

Food Waste Disposers

700 Series

Page i84

700 series food waste disposers allow small to medium-sized kitchens to remove waste quickly and efficiently, making them perfect for hotels, restaurants, schools and hospitals.

With a compact design, 700 series waste disposers offer an excellent solution for the disposal of medium waste - small pork and chicken bones, vegetables and fruit. A range of mounting options can be specified to suit each outlet, making the unit quick and easy to load, saving staff time.



800 Series

Page i85

Fast and powerful, 800 series food waste disposers provide the perfect solution for large catering operations, such as larger hotels, hospitals, universities and prisons, plus food preparation companies.

800 series food waste disposers offer excellent throughput and reliable performance with low operating costs. They allow the quick and easy removal of high quantities of tough food waste, including red meat bones, cauliflower stalks and fish skins. A range of mounting options can be specified to suit each outlet, making the unit quick and easy to load, saving staff time and labour.



04 & 04X Series

Page i86/i87

Reliable, efficient, safe and easy to operate, 04 and 04X waste disposers allow large operators to process heavy-duty food waste, quickly and efficiently.

Designed for use in large hotels and restaurants, hospitals, prisons, universities and by food preparation companies, 04 series waste disposers can handle medium to tough waste including fish skins, cauliflower stalks and larger meat bones. A range of mounting and hopper rim options can be specified to suit each outlet, making the unit quick and easy to load, saving time and energy.



Food Waste Disposers											
	723	725	726	904	904X	825	826	1204	1204X	1604	1604X
PAGE	i84	i84	i84	i86	i87	i85	i85	i86	i87	i86	i87
COVERS PER SITTING	400	850	850	1000	1000	1350	1350	1450	1450	1850	1850
WASTE PER HOUR KG	250	400	400	500	500	600	600	700	700	900	900
MOUNTING	Undersink	In tabling	Free standing	Floor mounted, can be mounted in	Floor mounted, can be mounted in	In tabling	Free standing	Floor mounted, can be mounted in	Floor mounted, can be mounted in	Floor mounted, can be mounted in	Floor mounted, can be mounted in
SOFT WASTE (PLATE WASTE, VEG, PEELINGS, MEAT AND FISH SCRAPS)	✓	✓	✓	✓	✓	✓	✓	✓	✓	✓	✓
MEDIUM WASTE (SMALL PORK AND CHICKEN BONES, VEGETABLES AND FRUIT)	✓	✓	✓	✓	✓	✓	✓	✓	✓	✓	✓
TOUGH WASTE (ALL RED MEAT BONES, CAULIFLOWER STALKS, FISH SKINS)	-	-	-	-	-	✓	✓	✓	✓	✓	✓
PHASES AVAILABLE	Single or three	Single or three	Single or three	Single or three	Single or three	Three	Three	Three	Three	Three	Three

2 YEAR UK parts and labour warranty | Export parts warranty
on all IMC products

Vulture 700 Series

723 Food Waste Disposers

- Fast and efficient disposal of up to 250 kg/hour
- Handles up to 400 covers per sitting - ideal for medium-size kitchens
- Under Sink mounted
- For medium waste (small pork and chicken bones, vegetables and fruit)
- Manually reversible motor to extend operational life



723 Food Waste Disposers															
MODEL	PRICE £	PRICE €	DESCRIPTION	PHASE	WIRE	AIR BREAK	MOUNTING	H	W	D	SINK OPENING	POWER	WASTE PER HR	COVERS PER HR	WT
* F60/305	£4188	€4817	723	1	-	No	Undersink	573	218	304	90*	1.1kW	200kg	400	33
* F60/310	£3908	€4495	723	3	4	No	Undersink	573	218	304	90*	1.1kW	200kg	400	33

725 Food Waste Disposers

- Fast and efficient disposal of up to 400kg of food waste per hour
- Handles up to 850 covers per sitting - ideal for medium-size kitchens
- For medium waste (small pork and chicken bones, vegetables and fruit)
- Compact design allows hopper to be table-mounted, for quick and easy loading
- Manually reversible motor to extend operational life
- Available with a class A airbreak kit, recommended for when connecting to a mains water supply



With Airbreak



725 Food Waste Disposers														
MODEL	PRICE £	PRICE €	DESCRIPTION	PHASE	WIRE	AIR BREAK	MOUNTING	H	W	D	POWER	WASTE PER HR	COVERS PER HR	WT
* F60/100	£5054	€5813	725	1	-	No	In tabling	733	340	472	1.1kW	400kg	850	48
* F60/500	£5916	€6804	725	1	-	Yes	In tabling	853	340	472	1.1kW	400kg	850	48
* F60/121	£4776	€5493	725	3	4	No	In tabling	733	340	472	1.1kW	400kg	850	48
* F60/444	£5588	€6427	725	3	4	Yes	In tabling	853	340	472	1.1kW	400kg	850	48
* F60/120	£4776	€5493	725	3	5	No	In tabling	733	340	472	1.1kW	400kg	850	48
* F60/515	£5588	€6427	725	3	5	Yes	In tabling	853	340	472	1.1kW	400kg	850	48

MODEL	PRICE £	PRICE €	DESCRIPTION
0* VS355	£324	€373	Water Flow Control
0* VS167	£286	€329	Magnetic Cutlery Saver

726 Food Waste Disposers

- Fast and efficient disposal of up to 400kg of food waste per hour
- Handles up to 850 covers per sitting - ideal for medium-size kitchens
- For medium waste (small pork and chicken bones, vegetables and fruit)
- Free Standing
- Manually reversible motor to extend operational life
- Available with a class A airbreak kit, recommended for when connecting to a mains water supply



With Airbreak



726 Food Waste Disposers														
MODEL	PRICE £	PRICE €	DESCRIPTION	PHASE	WIRE	AIR BREAK	MOUNTING	H	W	D	POWER	WASTE PER HR	COVERS PER HR	WT
* F60/200	£5670	€6521	726	1	-	No	Free standing	850	400	600	1.1kW	400kg	850	55
* F60/555	£6635	€7631	726	1	-	Yes	Free standing	969	400	600	1.1kW	400kg	850	55
* F60/221	£5387	€6196	726	3	4	No	Free standing	850	400	600	1.1kW	400kg	850	55
* F60/404	£6303	€7249	726	3	4	Yes	Free standing	969	400	600	1.1kW	400kg	850	55
* F60/220	£5387	€6196	726	3	5	No	Free standing	850	400	600	1.1kW	400kg	850	55
* F60/505	£6303	€7249	726	3	5	Yes	Free standing	969	400	600	1.1kW	400kg	850	55

MODEL	PRICE £	PRICE €	DESCRIPTION
0* VS352	£324	€373	Water Flow Control
0* E60/010	£125	€144	Side Panel
0* VS167	£286	€329	Magnetic Cutlery Saver

0* Factory fitted option please request at point of ordering

* Please refer to page i97 for electricity supply requirements

825 Food Waste Disposers

- Fast and efficient disposal of up to 600kg of food waste per hour
- Handles up to 1350 covers per sitting - ideal for large size kitchens
- Under sink mounted
- Efficient disposal of tough waste (red meat bones, cauliflower stalks and fish skins)
- Manually reversible motor to extend operational life
- Available with a class A airbreak kit, recommended for when connecting to a mains water supply



With Airbreak



825 Food Waste Disposers														
MODEL	PRICE £	PRICE €	DESCRIPTION	PHASE	WIRE	AIR BREAK	MOUNTING	H	W	D	POWER	WASTE PER HR	COVERS PER HR	WT
* F68/121	£8982	€10,330	825	3	4	No	In tabling	783	360	530	2.2kW	600kg	1350	59
* F68/324	£9113	€10,480	825	3	4	Yes	In tabling	919	360	530	2.2kW	600kg	1350	59
* F68/120	£8982	€10,330	825	3	5	No	In tabling	783	360	530	2.2kW	600kg	1350	59
* F68/325	£9113	€10,480	825	3	5	Yes	In tabling	919	360	530	2.2kW	600kg	1350	59

MODEL	PRICE £	PRICE €	DESCRIPTION
0* VS357	£324	€373	Water Flow Control
0* VS167	£286	€329	Magnetic Cutlery Saver

826 Food Waste Disposers

- Fast and efficient disposal of up to 600kg of food waste per hour
- Handles up to 1350 covers per sitting - ideal for large size kitchens
- Efficient disposal of tough waste (red meat bones, cauliflower stalks and fish skins)
- Free Standing
- Manually reversible motor to extend operational life
- Available with a class A airbreak kit, recommended for when connecting to a mains water supply



With Airbreak



826 Food Waste Disposers														
MODEL	PRICE £	PRICE €	DESCRIPTION	PHASE	WIRE	AIR BREAK	MOUNTING	H	W	D	POWER	WASTE PER HR	COVERS PER HR	WT
* F68/221	£9887	€11,371	826	3	4	No	Free standing	850	430	600	2.2kW	600kg	1350	73
* F68/326	£10,020	€11,523	826	3	4	Yes	Free standing	980	430	600	2.2kW	600kg	1350	73
* F68/220	£9887	€11,371	826	3	5	No	Free standing	850	430	600	2.2kW	600kg	1350	73
* F68/327	£10,020	€11,523	826	3	5	Yes	Free standing	980	430	600	2.2kW	600kg	1350	73

MODEL	PRICE £	PRICE €	DESCRIPTION
0* VS358	£324	€373	Water Flow Control
0* E68/013	£125	€144	Side Panel
0* VS167	£286	€329	Magnetic Cutlery Saver
0* VS258	£319	€367	Remote Control Box

Vulture 04 Series

904 Food Waste Disposers

- Fast and efficient disposal of up to 500kg of food waste per hour
- Handles up to 1000 covers per sitting - ideal for medium-large size kitchens
- Efficient disposal of medium waste (small pork and chicken bones, vegetables and fruit)
- Floor mounted†
- Manually reversible motor for extended operational life
- Available with a with class A airbreak kit, recommended for when connecting to a mains water supply



904 Food Waste Disposers														
MODEL	PRICE £	PRICE €	DESCRIPTION	PHASE	WIRE	AIR BREAK	MOUNTING	H	W	D	POWER	WASTE PER HR	COVERS PER HR	WT
*F54/100	£9376	€10,783	904	1	-	No	Floor mounted†	800-905	438	564	1.1kW	500kg	1000	60
*F54/730	£9510	€10,937	904	1	-	Yes	Floor mounted†	942-1047	438	564	1.1kW	500kg	1000	60
*F54/120	£9035	€10,391	904	3	4	No	Floor mounted†	800-905	438	564	1.1kW	500kg	1000	60
*F54/731	£9170	€10,546	904	3	4	Yes	Floor mounted†	942-1047	438	564	1.1kW	500kg	1000	60

†Can be welded into tabling with optional hopper rim accessory

MODEL	PRICE £	PRICE €	DESCRIPTION
A E30/095	£204	€235	Hopper rim
0* VS353	£329	€379	Water flow control
0* VS167	£286	€329	Magnetic cutlery saver
0* S55/016	£326	€375	Remote button box

1204 Food Waste Disposers

- Fast and efficient disposal of up to 600kg of food waste per hour
- Handles up to 1450 covers per sitting - ideal for large size kitchens
- Efficient disposal of tough waste (red meat bones, cauliflower stalks and fish skins)
- Floor mounted†
- Manually reversible motor for extended operational life
- Available with a with class A airbreak kit, recommended for when connecting to a mains water supply



1204 Food Waste Disposers														
MODEL	PRICE £	PRICE €	DESCRIPTION	PHASE	WIRE	AIR BREAK	MOUNTING	H	W	D	POWER	WASTE PER HR	COVERS PER HR	WT
*F54/220	£12,026	€13,830	1204	3	4	No	Floor mounted†	850-900	514	740	2.2kW	700kg	1450	84
*F54/724	£12,159	€13,983	1204	3	4	Yes	Floor mounted†	1014-1064	514	740	2.2kW	700kg	1450	84

†Can be welded into tabling with optional hopper rim accessory

MODEL	PRICE £	PRICE €	DESCRIPTION
A E30/096	£204	€235	Hopper rim
0* VS356	£329	€379	Water flow control
0* VS279	£582	€670	Magnetic cutlery saver
0* S55/016	£326	€375	Remote button box

1604 Food Waste Disposers

- Fast and efficient disposal of up to 900kg of food waste per hour
- Handles up to 1850 covers per sitting - ideal for large size kitchens
- Efficient disposal of tough waste (red meat bones, cauliflower stalks and fish skins)
- Floor mounted†
- Manually reversible motor for extended operational life
- Available with a with class A airbreak kit, recommended for when connecting to a mains water supply



1604 Food Waste Disposers														
MODEL	PRICE £	PRICE €	DESCRIPTION	PHASE	WIRE	AIR BREAK	MOUNTING	H	W	D	POWER	WASTE PER HR	COVERS PER HR	WT
*F54/320	£13,276	€15,268	1604	3	4	No	Floor mounted†	850-900	514	740	4kW	900kg	1850	93
*F54/727	£13,412	€15,424	1604	3	4	Yes	Floor mounted†	1014-1064	514	740	4kW	900kg	1850	93

†Can be welded into tabling with optional hopper rim accessory

MODEL	PRICE £	PRICE €	DESCRIPTION
A E30/096	£204	€235	Hopper rim
0* VS356	£329	€379	Water flow control
0* VS279	£582	€670	Magnetic cutlery saver
0* S55/016	£326	€375	Remote button box

0* Factory fitted option please request at point of ordering

* Please refer to page i97 for electricity supply requirements

904X Food Waste Disposers

- Fast and efficient disposal of up to 500kg of food waste per hour
- Handles up to 1000 covers per sitting - ideal for medium-large size kitchens
- Efficient disposal of medium waste (small pork and chicken bones, vegetables and fruit)
- Floor mounted†
- Manually reversible motor for extended operational life
- Low-load cut-outs ensure energy and water efficiency
- Available with a with class A airbreak kit, recommended for when connecting to a mains water supply

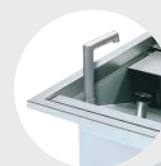

With Airbreak



904X Food Waste Disposers														
MODEL	PRICE £	PRICE €	DESCRIPTION	PHASE	WIRE	AIR BREAK	MOUNTING	H	W	D	POWER	WASTE PER HR	COVERS PER HR	WT
* F54/500	£10,008	€11,510	904X	1	-	No	Floor mounted†	800-905	438	564	1.1kW	500kg	1000	60
* F54/732	£10,143	€11,665	904X	1	-	Yes	Floor mounted†	942-1047	438	564	1.1kW	500kg	1000	60
* F54/520	£9653	€11,101	904X	3	4	No	Floor mounted†	800-905	438	564	1.1kW	500kg	1000	60
* F54/733	£9789	€11,258	904X	3	4	Yes	Floor mounted†	942-1047	438	564	1.1kW	500kg	1000	60
* F54/521	£9653	€11,101	904X	3	5	No	Floor mounted†	800-905	438	564	1.1kW	500kg	1000	60
* F54/734	£9789	€11,258	904X	3	5	Yes	Floor mounted†	942-1047	438	564	1.1kW	500kg	1000	60

†Can be welded into tabling with optional hopper rim accessory

MODEL	PRICE £	PRICE €	DESCRIPTION
A E30/095	£204	€235	Hopper rim
0* VS167	£286	€329	Magnetic Cutlery Saver
0* S54/026	£326	€375	Remote button box

1204X Food Waste Disposers

- Fast and efficient disposal of up to 600kg of food waste per hour
- Handles up to 1450 covers per sitting - ideal for large size kitchens
- Efficient disposal of tough waste (red meat bones, cauliflower stalks and fish skins)
- Floor mounted†
- Manually reversible motor for extended operational life
- Low-load cut-outs ensure energy and water efficiency
- Available with a with class A airbreak kit, recommended for when connecting to a mains water supply



With Airbreak



1204X Food Waste Disposers														
MODEL	PRICE £	PRICE €	DESCRIPTION	PHASE	WIRE	AIR BREAK	MOUNTING	H	W	D	POWER	WASTE PER HR	COVERS PER HR	WT
* F54/621	£12,661	€14,561	1204X	3	4	No	Floor mounted†	850-900	514	740	2.2kW	700kg	1450	84
* F54/725	£12,794	€14,714	1204X	3	4	Yes	Floor mounted†	1014-1064	514	740	2.2kW	700kg	1450	84
* F54/620	£12,661	€14,561	1204X	3	5	No	Floor mounted†	850-900	514	740	2.2kW	700kg	1450	84
* F54/726	£12,794	€14,714	1204X	3	5	Yes	Floor mounted†	1014-1064	514	740	2.2kW	700kg	1450	84

†Can be welded into tabling with optional hopper rim accessory

MODEL	PRICE £	PRICE €	DESCRIPTION
A E30/096	£223	€257	Hopper rim
0* VS356	£329	€379	Water flow control
0* VS279	£582	€670	Magnetic cutlery saver
0* S54/026	£326	€375	Remote button box

1604X Food Waste Disposers

- Fast and efficient disposal of up to 900kg of food waste per hour
- Handles up to 1850 covers per sitting - ideal for large size kitchens
- Efficient disposal of tough waste (red meat bones, cauliflower stalks and fish skins)
- Floor mounted†
- Manually reversible motor for extended operational life
- Low-load cut-outs ensure energy and water efficiency
- Available with a with class A airbreak kit, recommended for when connecting to a mains water supply



With Airbreak



1604X Food Waste Disposers														
MODEL	PRICE £	PRICE €	DESCRIPTION	PHASE	WIRE	AIR BREAK	MOUNTING	H	W	D	POWER	WASTE PER HR	COVERS PER HR	WT
* F54/721	£13,913	€16,000	1604X	3	4	No	Floor mounted†	850-900	514	740	4kW	900kg	1850	93
* F54/728	£14,048	€16,156	1604X	3	4	Yes	Floor mounted†	1014-1064	514	740	4kW	900kg	1850	93
* F54/720	£13,913	€16,000	1604X	3	5	No	Floor mounted†	850-900	514	740	4kW	900kg	1850	93
* F54/729	£14,048	€16,156	1604X	3	5	Yes	Floor mounted†	1014-1064	514	740	4kW	900kg	1850	93

†Can be welded into tabling with optional hopper rim accessory

MODEL	PRICE £	PRICE €	DESCRIPTION
A E30/096	£223	€257	Hopper rim
0* VS356	£329	€379	Water flow control
0* VS279	£582	€670	Magnetic cutlery saver
0* S54/026	£326	€375	Remote button box

0* Factory fitted option please request at point of ordering

* Please refer to page i97 for electricity supply requirements



IP COMPACTOR



Cut waste volumes by up to 80% with an IP Compactor.

Designed to compress all dry waste, including cardboard, tins, plastic and paper, our range of IP Compactors are tough, reliable and simple to use.

The IP waste compactor range has been developed to meet the needs of almost every application, from small hotels and restaurants to large schools, hospitals, shops, factories and ships. IP Compactors will give you a fast return on your investment, help you to improve hygiene standards and minimise the area needed for waste storage.

Manufactured from stainless steel, they are quick and easy to clean. Each incorporates proven electro-hydraulic technology to ensure that waste is compacted in seconds. Quiet, safe and energy efficient, IP Compactors operate from a standard 13 amp plug.

Our units are compact, easy to use and mounted on heavy duty casters or deck feet, so they can be located wherever waste is produced. Waste is fed via a loading chute into an integral trolley, lined with a tough, sealable plastic bag. In the case of the larger model, it is fed directly into standard 240-litre wheeled bins.

Ideally suited for...

Compress all dry waste in one compact unit. IP Compactors are suitable for:



Hotels and restaurants

Save valuable staff time and cut collection costs with a powerful waste compactor. IP Compactors can help streamline your waste management processes.

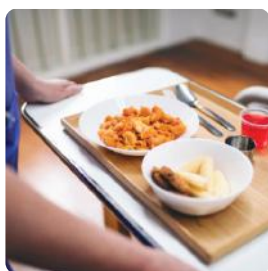

Hospitals

Handle high volumes of waste quickly, efficiently and cost-effectively with a waste compactor.

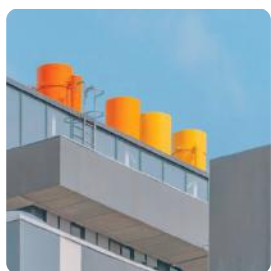

Factories

Boost your recycling efforts and become greener by compacting your waste. IP Compactors can help deliver cost savings and reduce staff labour.

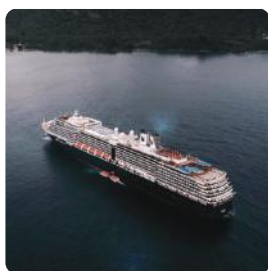

Ships

Need to handle high volumes of waste from on-board retail and leisure outlets, and passengers? Let our IP Compactor solve the problem - whilst saving you time and money.

Boost your recycling efforts with a an IP Compactor.

Benefits at a glance

- Cut your waste volumes by up to 80%
- Designed to compress all dry waste, including cardboard, tins, plastic and paper
- Tough, reliable and simple to use
- Quiet, safe and energy efficient
- Avoid heavy lifting, models with trolley or bin to wheel to disposal point
- Minimise the area needed for waste storage

IP COMPACTOR

IP400 Waste Compactor

- Small to large applications
- Cuts waste volumes by up to 80% and lowers waste handling and collection costs
- Compresses all dry waste - cardboard, tins, plastic and paper
- Powerful electro-hydraulic technology enables waste to be compacted in seconds
- Compact, easy-to-move unit can be conveniently located where waste is produced
- Manufactured from stainless steel making it tough, reliable and easy to clean
- UK 3 pin plug allows users to simply plug in and switch on



IP500 Waste Compactor

- Small to large applications
- Cuts waste volumes by up to 80% and lowers waste handling and collection costs
- Compresses all dry waste - cardboard, tins, plastic and paper
- Powerful electro-hydraulic technology enables waste to be compacted in seconds
- Compact, easy-to-move unit can be conveniently located where waste is produced
- Manufactured from stainless steel making it tough, reliable and easy to clean
- UK 3 pin plug allows users to simply plug in and switch on



IP400 Waste Compactor											
MODEL	PRICE £	PRICE €	DESCRIPTION	H	W	D	POWER	STORAGE CAPACITY	EQUIVALENT UNCRUSHED	COMPACTION RATIO	WT
F56/400	£14,872	€17,103	IP400	1645	580	566	750W	55L	275L	5:1	242.5

MODEL	PRICE £	PRICE €	DESCRIPTION
C S56/059	£262.15	€301.50	Bags and ties (100 pack)
A S56/060	£3282	€3775	Lift-a Pak - Allows compacted bags to be easily lifted into storage skip
A S56/049	£1745	€2007	Additional trolley

IP500 Waste Compactor											
MODEL	PRICE £	PRICE €	DESCRIPTION	H	W	D	POWER	STORAGE CAPACITY	EQUIVALENT UNCRUSHED	COMPACTION RATIO	WT
F56/500	£16,487	€18,961	IP500	1740	678	675	750W	110L	550L	5:1	326

MODEL	PRICE £	PRICE €	DESCRIPTION
C S56/055	£262.15	€301.50	Bags and ties (100 pack)
A S56/060	£3282	€3775	Lift-a Pak - Allows compacted bags to be easily lifted into storage skip
A S56/054	£1914	€2202	Additional trolley

IP600 Waste Compactor

- Small to large applications
- Cuts waste volumes by up to 80% and lowers waste handling and collection costs
- Compresses all dry waste - cardboard, tins, plastic and paper
- Powerful electro-hydraulic technology enables waste to be compacted in seconds
- Compact, easy-to-move unit can be conveniently located where waste is produced
- Manufactured from stainless steel making it tough, reliable and easy to clean
- UK 3 pin plug allows users to simply plug in and switch on



IP700 Waste Compactor

- Small to large applications
- Cuts waste volumes by up to 80% and lowers waste handling and collection costs
- Compacts waste directly into a wheelie bin
- Compresses all dry waste - cardboard, tins, plastic and paper
- Powerful electro-hydraulic technology enables waste to be compacted in seconds
- Compact, easy-to-move unit can be conveniently located where waste is produced
- Manufactured from stainless steel making it tough, reliable and easy to clean
- UK 3 pin plug allows users to simply plug in and switch on



IP600 Waste Compactor											
MODEL	PRICE £	PRICE €	DESCRIPTION	H	W	D	POWER	STORAGE CAPACITY	EQUIVALENT UNCRUSHED	COMPACTION RATIO	WT
F56/600	£18,595	€21,385	IP600	1930	840	858	750W	210L	1050L	5:1	457

MODEL	PRICE £	PRICE €	DESCRIPTION
S S56/052	£262.15	€301.50	Bags and ties (100 pack)
A S56/060	£3282	€3775	Lift-a Pak - Allows compacted bags to be easily lifted into storage skip
A S56/051	£1945	€2237	Additional trolley

IP700 Waste Compactor											
MODEL	PRICE £	PRICE €	DESCRIPTION	H	W	D	POWER	STORAGE CAPACITY	EQUIVALENT UNCRUSHED	COMPACTION RATIO	WT
F56/700	£18,339	€21,090	IP700	1930	840	858	750W	240L	1200L	5:1	345



Lift-a Pak S56/060

60Hz models available, please see lincat.co.uk for details



Cleaning & Rinsing

- Mobile Hand Wash Stations • Mobile Hand Sanitising Stations
- Power Brush • Compact Hose Reels



Help keep your organisation Covid-19 secure with our range of hand washing and sanitising solutions.

The IMClean range of Mobile Hand Wash Stations are ideal for any organisation who need to add to their existing hand wash facilities, but don't have a water and a power supply available for where it needs to be located.

The IMClean Mobile Hand Sanitising Stations which dispense sanitising gel are ideal for high-traffic areas such as entrances to supermarkets, restaurants, pubs, coffee shops, doctors and dental surgeries, receptions, offices and many other venues.

Behind the scenes the IMClean range helps organisations meet stringent hygiene standards and save valuable time with effective cleaning and rinsing solutions.

Benefits at a glance

- Ideal for organisations who need to increase their hand cleaning facilities
- No water or power supply required for the where the unit is to be located
- Reduced height versions available for children
- Give customers confidence
- Helps meet healthy and safety, and hygiene standards
- Safe and easy to use

Ideally suited for...



Supermarkets and shops

Ideal for high traffic areas such as entrances to supermarkets and shops, the IMClean Mobile Hand Sanitising Station can provide reassurance to your customers and help you maintain hygiene standards.



Nurseries and schools

The IMClean Junior Mobile Reduced Height Hand Wash Station is more than just a sink. With its splashback, soap dispenser and paper towel holder it is a fully mobile, all-in-one compact solution which can be located anywhere - whether that be in the middle of the playground or in the entrance to the nursery or school.



Doctors and dental surgeries

With a stream of patients passing through the surgery doors every day, help keep germs at bay and keep your clinic Covid-19 secure with an IMClean Mobile Hand Sanitising Station.



Cost Sector

Whether you're a school, hospital or university kitchen, speed up the cleaning of pans and cookware with Pot Boy. It is ideal for removing tough debris, saving on staff wash-up time.



Contents



Mobile Hand Wash Stations
Provide extra hand wash facilities without the need for plumbed services

Ideally suited for:

Organisations looking to extend their existing hand wash facilities.

Why choose a Mobile Hand Wash Station?

- Provide extra hand washing facilities
- No location restrictions, just fill with water and you are ready to go

- Tap dispense via foot action, ensures hygienic operation, with no need for hand contact
- Reduced height version available for nurseries and schools

Find out more on page **i94**



Mobile Hand Sanitising Stations
Help keep people healthy when they're outside the home.

Ideally suited for:

Areas with high footfall including entrances to supermarkets, restaurants, doctors, offices and many other venues.

Why choose a Mobile Hand Sanitising Station?

- Increase customer confidence
- No location restrictions, just fill with sanitiser and you are ready to go
- Reduced height version available for children

- Tap dispense via foot action, ensures hygienic operation, with no need for hand contact
- Large capacity, reduces how frequently the sanitiser gel requires refilling

Find out more on page **i95**



Pot Boy Power Brush
Remove burnt deposits from pans and cookware

Ideally suited for:

Restaurants and canteens, looking to meet stringent hygiene standards and save valuable staff time, with an effective cleaning solution.

Why choose a Pot Boy power brush?

- Effective removal of debris
- Saves time and increases efficiency
- Safe and easy to use

Find out more on page **i96**



Soak Tank
Remove stubborn carbon, fat and grease deposits from cookware

Ideally suited for:

Any establishment looking to meet stringent hygiene standards and save valuable staff time, with an effective cleaning solution.

Why choose a Soak Tank?

- Effective removal of debris
- Improve the effectiveness and efficiency of subsequent dishwasher cleaning

- Safely holds and transports a high volume of liquids and trays
- Compact footprint for busy kitchens
- Saves time and increases efficiency

Find out more on page **i96**



Reel Kleen Hose Reels
Space-saving hose reels

Ideally suited for:

Any establishment looking to meet stringent hygiene standards and save valuable staff time, with an effective cleaning solution.

Why choose a Reel Kleen hose reel?

- Space saving
- Mount to the ceiling, floor or wall
- Allows kitchen wash-up areas to be quickly and hygienically hosed down

Find out more on page **i96**

The IMClean

Mobile Hand Cleansing Station Product Line Up

We offer a range of Mobile Hand Cleansing Stations to suit any application



IMC Mobile Hand Wash Station F63/501

IMC Mobile Hand Wash Station F63/502

IMC Mobile Hand Wash Station F63/503

IMC Mobile Hand Wash Station F63/700

WATER TEMPERATURE	Heated up to 42°C	Heated up to 42°C	Ambient	Ambient
OPERATION	Infra Red	Foot Pump	Foot Pump	Foot Pump
OVERALL POWER	3kW	3kW No power supply, use to dispense ambient temperature water.	No power required!	No power required!
WATER TANK CAPACITY	10 Litres	20 Litres Dispenses up to 100ml per foot press, delivering 200 dispenses from one tank.	20 Litres Dispenses up to 100ml per foot press, delivering 200 dispenses from one tank.	20 Litres Dispenses up to 100ml per foot press, delivering 200 dispenses from one tank.
DIMENSIONS H x W x D	1250mm x 450mm x 543mm	1220mm x 520mm x 543mm	1220mm x 520mm x 543mm	1003mm x 520mm x 592mm (700mm to counter top)
REFILL / EMPTYING	Rear Access. Fixed tank fill using funnel. Easy to remove waste container.	Top fill. Front access easy to remove waste container.	Front Access. Easy to remove fresh water and waste containers.	Front Access. Easy to remove fresh water and waste containers.
NEW WEIGHT	41 kg	44 kg	36 kg	33 kg
LIST PRICE	£1629 / €1874	£1396 / €1606	£915 / €1053	£915 / €1053



The NHS says that washing your hands is a key part of preventing the spread of coronavirus (COVID-19). This can put pressure on existing hand washing facilities.



NO POWER
SUPPLY
REQUIRED

 
NO POWER
SUPPLY
REQUIRED
DESIGNED
FOR
CHILDREN



IMC Mobile Hand Sanitising Station F63/250

IMC Mobile Hand Sanitising Station F63/251

OPERATION	F63/250	F63/251
OPERATION	Foot Pump	Foot Pump
OVERALL POWER	No power required!	No power required!
SANITISING GEL CAPACITY	5 Litres	5 Litres
DIMENSIONS H x W x D	1294mm x 250mm x 369mm	1074mm x 250mm x 369mm (700mm to counter top)
REFILL / EMPTYING	Back Access. Space for 2 x 5 litre containers of sanitising liquid.	Back Access. Space for 2 x 5 litre containers of sanitising liquid.
NEW WEIGHT	16 kg	16 kg
LIST PRICE	£635 / €731	£635 / €731



Pot Boy Power Brush

- Effectively removes burnt deposits from pans and cookware
- Compact design allows the Pot Boy to be mounted over sink units
- Can be moved by a trolley (optional) to fixed equipment, for cleaning in-situ
- Efficient, foot-operated pneumatic switch enables quick and easy operation
- Unique hydraulic system means brush is driven by a fluid circuit, for safety
- Tough, long-lasting nylon brush head
- Available with wall-mounting plate, to save space



S64/090
Trolley



U07/012 Nylon
Brush Head



S64/103
Magikut Pads



Pot Boy Power Brush												
MODEL	PRICE £	PRICE €	DESCRIPTION	H	W	D	POWER	MOTOR (BHP)	HEAD SPEED	REACH OF HOSE	HOSE LENGTH	WT
F64/100	£7630	€8775	Pot Boy	265	625	245	370W	0.5	360rpm	2m	2m	25

MODEL	PRICE £	PRICE €	DESCRIPTION
S S64/090	£733	€843	Trolley
C S64/103	£357	€410.55	Magikut pads (5)
C U07/012	£197.90	€227.60	Nylon brush head

Soak Tank

- Remove stubborn carbon, fat and grease deposits from cookware and other kitchen utensils
- Improve the effectiveness and efficiency of subsequent dishwasher cleaning
- Safely holds and transports a high volume of liquid and trays
- Compact footprint for busy kitchens
- Accommodates four trays/baskets up to 675mm x 740mm x 95mm
- Lid with two oil and grease resistant handles for safe usage
- Wide drain valve for easy evacuation of the waste water
- Safety latch on drain valve to protect from accidental evacuation of the waste water
- Tank trolley with braked castors – easy to manoeuvre and lock in position
- Enclosed tray – for storing PPE required for handling undiluted chemicals (goggles and gauntlets)
- Fully welded grade 304 stainless steel construction – provides superior resistance to corrosion from water



Soak Tank									
MODEL	PRICE £	PRICE €	DESCRIPTION	H	W	D	CAPACITY	WT	
F64/200	£1810	€2082	Soak Tank	858	360	868	140L	40	

Reel Kleen 15 Hose Reel

- Space-saving hose reel, that can be mounted on the wall, ceiling, or floor
- Allows kitchen wash-up areas to be quickly and hygienically hosed down
- Reinforced, retractable 4.5-metre hose reduces trip risk in your kitchen
- Built in multi-bracket for wall, floor or ceiling mounting
- Water temperature up to 82°C



Reel Kleen 15 Hose Reel									
MODEL	PRICE £	PRICE €	DESCRIPTION	H	W	D	REACH OF HOSE	HOSE LENGTH	WT
U05/013	£2315	€2663	Reel Kleen 15	250	250	100	4.5m	4.5m	7.5

Reel Kleen 35 Hose Reel

- Space-saving hose reel, that can be mounted on the wall, ceiling, or floor
- Allows kitchen wash-up areas to be quickly and hygienically hosed down
- Reinforced, retractable 10-metre hose reduces trip risk in your kitchen
- Built in multi-bracket for wall, floor or ceiling mounting
- Water temperature up to 82°C



Reel Kleen 35 Hose Reel									
MODEL	PRICE £	PRICE €	DESCRIPTION	H	W	D	REACH OF HOSE	HOSE LENGTH	WT
U05/012	£2689	€3093	Reel Kleen 35	560	560	120	10m	10m	16

Electricity Supply Requirements

Electrical products not listed on this page are supplied for operation on a 230/240v, 13 amp supply.

Brand	Product Code	Power Supply/ Connection Type	Electrical Supply Rating [watts]	Single Phase		Three Phase			
				Amps	Voltage	Amps - Phase 1	Amps - Phase 2	Amps - Phase 3	Voltage
IMC	F52/301	1-phase	550	5.2	230				
IMC	F52/321	3-phase [4 wire]	550		N/A	1.7	1.7	1.7	400
IMC	F52/500	1-phase	550	5.2	230				
IMC	F52/510	1-phase	550	5.2	230				
IMC	F52/520	3-phase [4 wire]	550		N/A	1.7	1.7	1.7	400
IMC	F52/530	3-phase [4 wire]	550		N/A	1.7	1.7	1.7	400
IMC	F52/602	1-phase	550	5.2	230				
IMC	F52/612	1-phase	550	5.2	230				
IMC	F52/622	3-phase [4 wire]	550		N/A	1.7	1.7	1.7	400
IMC	F52/632	3-phase [4 wire]	550		N/A	1.7	1.7	1.7	400
IMC	F54/100	1-phase	1,100	7.4	230				
IMC	F54/120	3-phase [4 wire]	1,100		N/A	2.8	2.8	2.8	400
IMC	F54/220	3-phase [4 wire]	2,200		N/A	4.8	4.8	4.8	400
IMC	F54/320	3-phase [4 wire]	4,000		N/A	9.4	9.4	9.4	400
IMC	F54/322	3-phase [4 wire]	4,000		N/A	8.7	8.7	8.7	400
IMC	F54/500	1-phase	1,100	7.4	230				
IMC	F54/520	3-phase [4 wire]	1,100		N/A	2.8	2.8	2.8	400
IMC	F54/521	3-phase [5 wire]	1,100		N/A	2.8	2.8	2.8	400
IMC	F54/620	3-phase [5 wire]	2,200		N/A	5.1	5.1	5.1	400
IMC	F54/621	3-phase [4 wire]	2,200		N/A	5.1	5.1	5.1	400
IMC	F54/720	3-phase [5 wire]	4,000		N/A	8.7	8.7	8.7	400
IMC	F54/721	3-phase [4 wire]	4,000		N/A	8.7	8.7	8.7	400
IMC	F54/724	3-phase [4 wire]	2,200		N/A	4.8	4.8	4.8	400
IMC	F54/725	3-phase [4 wire]	2,200		N/A	5.1	5.1	5.1	400
IMC	F54/726	3-phase [5 wire]	2,200		N/A	5.1	5.1	5.1	400
IMC	F54/727	3-phase [4 wire]	4,000		N/A	9.4	9.4	9.4	400
IMC	F54/728	3-phase [4 wire]	4,000		N/A	8.7	8.7	8.7	400
IMC	F54/729	3-phase [5 wire]	4,000		N/A	8.7	8.7	8.7	400
IMC	F54/730	1-phase	1,100	7.4	230				
IMC	F54/731	3-phase [4 wire]	1,100		N/A	2.8	2.8	2.8	400
IMC	F54/732	1-phase	1,100		N/A	2.8	2.8	2.8	400
IMC	F54/733	3-phase [4 wire]	1,100		N/A	7.4	7.4	7.4	400
IMC	F54/734	3-phase [5 wire]	1,100		N/A	2.8	2.8	2.8	400
IMC	F56/401	EU 2 Pin Plug	750	5	230				
IMC	F56/501	EU 2 Pin Plug	750	5	230				
IMC	F56/601	EU 2 Pin Plug	750	5	230				
IMC	F56/701	EU 2 Pin Plug	750	5	230				
IMC	F58/901	3-phase	370		N/A	1.1	1.1	1.1	400
IMC	F58/903	3-phase	370		N/A	1.1	1.1	1.1	400
IMC	F58/911	3-phase	750		N/A	2.1	2.1	2.1	400
IMC	F58/913	3-phase	750		N/A	2.1	2.1	2.1	400
IMC	F59/440	3-phase	1,100		N/A	1.1	1.1	1.1	400
IMC	F59/500	1-phase	330	1.6	230				
IMC	F59/500/L	1-phase	330	1.6	230				
IMC	F59/510	1-phase	481	2.1	230				
IMC	F59/510/L	1-phase	481	2.1	230				
IMC	F59/511	3-phase	660		N/A	0.4	0.4	0.4	400
IMC	F59/511/L	3-phase	660		N/A	0.4	0.4	0.4	400
IMC	F59/520	1-phase	481	2.1	230				
IMC	F59/520/L	1-phase	481	2.1	230				
IMC	F59/521	3-phase	660		N/A	0.4	0.4	0.4	400
IMC	F59/521/L	3-phase	660		N/A	0.4	0.4	0.4	400
IMC	F59/710	1-phase	481	2.1	230				
IMC	F59/720	3-phase	660		N/A	0.4	0.4	0.4	400
IMC	F59/730	1-phase	481	2.1	230				
IMC	F59/740	3-phase	660		N/A	0.4	0.4	0.4	400
IMC	F60/100	1-phase	1,100	7.4	230				
IMC	F60/120	3-phase [5 wire]	1,100		N/A	2.8	2.8	2.8	400
IMC	F60/121	3-phase [4 wire]	1,100		N/A	2.8	2.8	2.8	400
IMC	F60/200	1-phase	1,100	7.4	230				
IMC	F60/220	3-phase [5 wire]	1,100		N/A	2.8	2.8	2.8	400
IMC	F60/221	3-phase [4 wire]	1,100		N/A	2.8	2.8	2.8	400
IMC	F60/305	1-phase	1,100	7.4	230				
IMC	F60/310	3-phase [4 wire]	1,100		N/A	2.8	2.8	2.8	400
IMC	F60/404	3-phase [4 wire]	1,100		N/A	2.8	2.8	2.8	400
IMC	F60/444	3-phase [4 wire]	1,100		N/A	2.8	2.8	2.8	400
IMC	F60/500	1-phase	1,100	7.4	230				
IMC	F60/505	3-phase [5 wire]	1,100		N/A	2.8	2.8	2.8	400
IMC	F60/515	3-phase [5 wire]	1,100		N/A	2.8	2.8	2.8	400
IMC	F60/555	1-phase	1,100	7.4	230				
IMC	F68/120	3-phase [5 wire]	2,200		N/A	5.3	5.3	5.3	400
IMC	F68/121	3-phase [4 wire]	2,200		N/A	5.3	5.3	5.3	400
IMC	F68/220	3-phase [5 wire]	2,200		N/A	5.3	5.3	5.3	400
IMC	F68/221	3-phase [4 wire]	2,200		N/A	5.3	5.3	5.3	400
IMC	F68/324	3-phase [4 wire]	2,200		N/A	5.3	5.3	5.3	400
IMC	F68/325	3-phase [5 wire]	2,200		N/A	5.3	5.3	5.3	400
IMC	F68/326	3-phase [4 wire]	2,200		N/A	5.3	5.3	5.3	400
IMC	F68/327	3-phase [5 wire]	2,200		N/A	5.3	5.3	5.3	400
IMC	F78/020	3-phase [4 wire]	1,950		N/A	5.5	5.5	5.5	400
IMC	F78/030	3-phase [4 wire]	1,950		N/A	5.5	5.5	5.5	400
IMC	F79/010	3-phase	4,100		N/A	8.62	8.62	8.62	380-415
IMC	F79/100	3-phase	4,100		N/A	8.62	8.62	8.62	380-415
IMC	F79/701	1-phase	2,950	13	230				
IMC	F79/703	3-phase	2,950		N/A	4.3	4.3	4.3	400

All weights stated are packed weights.

Warning UK: In accordance with The Gas Safety (Installation and Use Amendment Regulations 1998) gas appliances must be installed by commercial catering equipment engineers certified by the Gas Safety Register. Failure to comply with this will render any non registered installer liable to prosecution and will invalidate the guarantee.

For Sale terms and conditions please visit lincat.co.uk/sale-terms-conditions



Britannia

kitchen ventilation

PRODUCT RANGE & PRICE LIST



SPECIALISING IN

- VENTILATION
- RECIRCULATION



Contents



Create a clean and fresh working environment
Ventilation

Ideally suited for:

Fast food outlets, smaller pubs and restaurants and cafes, ensure that your staff are focused only on delivering the very best quality food by keeping the air clean and clear.

Why choose SmartVent?

- Easy to install
- Efficiently remove kitchen smoke and odours
- Provides a safer and more comfortable place for staff to work in
- A real alternative to expensive bespoke kitchen ventilation
- Great for tight installation deadlines
- Gas and electric compatible
- Modular in design and robustly constructed

Find out more on page **B3**



Providing a safer, more comfortable and productive working environment
Recirculation

Ideally suited for:

Restricted buildings, concession areas, temporary catering, pubs, snack bars and coffee shops where venting to the atmosphere is impossible or costly.

Why choose Refresh?

- Quick and easy to install
- Filtration process removes grease, fine particles, smoke and odours
- Provides a safer, more comfortable and productive working environment
- For use with electrical appliances
- Constructed from polished stainless steel for long term durability and easier cleaning

Find out more on page **B5**

All prices are exclusive of VAT.

2 YEAR UK parts and labour warranty | Export parts warranty
on all IMC products

UK
Goods are normally delivered free of charge to either the dealers' address or direct within 3 working days. If overnight and/or premium services are required charges will apply.

Export
Goods are priced ex works, export crates POA.

- ☎ UK Tel: 01522 875500
- ☎ Export Tel: +44 1522 503250
- ✉ UK e-mail: sales@lincat.co.uk
- ✉ Export e-mail: export@lincat.co.uk



Britannia

kitchen ventilation

smart
vent



SmartVent creates a clean and fresh working environment

The SmartVent Canopy Extraction System is designed to efficiently remove kitchen smoke and odours, making your kitchen a safer and more comfortable place for staff to work in.

A real alternative to expensive bespoke kitchen ventilation, the system is modular in design and robustly constructed. Facing challenging

installation deadlines? The SmartVent Canopy Extraction System can help with that.

The cost-effective system is flexible, with four different length options, it's easy to install, and it's compatible with both gas and electric cooking equipment.

Ideally suited for...

The SmartVent Canopy Extraction System is perfect for the cost conscious buyer working to tight deadlines. It suits a variety of venues, including the following:



Fast food outlets

Are your staff working flat out to deliver quality fast food around the clock? Keep them cool and safe while they work.



Smaller pubs and restaurants

Ensure that your staff are focused only on delivering the very best quality food by keeping the air clean and clear.



Cafes

Perfect for removing smoke and odours to make for a more comfortable experience for your staff as well as your customers.

Efficiently remove kitchen smoke and odours, making your kitchen safer and more comfortable for staff to work in.

Benefits at a glance

- Flexible
- Efficient
- Easy to install
- Cost-effective
- Great for tight installation deadlines
- Gas and electric compatible



SmartVent Canopy Extraction Ventilation System

- Canopy extraction system suitable for use with gas and electric cooking equipment up to 900 series
- Choice of fan position (please see box at bottom of page)
- Variable fan speed enables selection of the required level of ventilation to suit kitchen output throughout the day
- Reduces energy consumption by using lower fan speeds during quieter periods
- Bright energy-efficient LED lighting provided as standard
- Supplied with a wall mounted variable fan speed controller
- Simple to install



1200mm long SmartVent							
MODEL	PRICE £	PRICE €	L	W	D	POWER	WT
SV1212	£3376	€3883	1200	1200	748	0.12kW	85



1600mm long SmartVent							
MODEL	PRICE £	PRICE €	L	W	D	POWER	WT
SV1216	£3666	€4216	1200	1600	740	0.12kW	105



2000mm long SmartVent							
MODEL	PRICE £	PRICE €	L	W	D	POWER	WT
SV1220	£4298	€4943	1200	2000	740	0.12kW	126



2400mm long SmartVent							
MODEL	PRICE £	PRICE €	L	W	D	POWER	WT
SV1224	£4720	€5428	1200	2400	740	0.12kW	147

Please note that ductwork and gas interlocks are not included. Please contact our sales desk for advise on suppliers.

When placing an order please specify your preferred fan position by adding one of the following codes to the end of the SmartVent model number.

LH - Left fan horizontally mounted	CH - Central fan horizontally mounted	RH - Right fan horizontally mounted
LV - Left fan vertically mounted	CV - Central fan vertically mounted	RV - Right fan vertically mounted

Example: SV1216RH = 1600mm long canopy with fan positioned to the right and exiting horizontally.
Please refer to the SmartVent brochure for further details.

Britannia

kitchen ventilation

Refresh
Recirculation Unit



For kitchens that require ventless cooking, the Refresh range of self-contained kitchen ventilation and air recirculation systems are the ideal solution.

Free-standing Refresh units are available in a range of sizes and can be installed quickly and easily, with minimal disruption to service. They are equipped with an extract and supply canopy, along with a services tower that houses a powerful, efficient fan unit. Air is drawn out through the canopy, before passing through five filtration stages to remove grease, fine particles, smoke and odours.

The grease and smoke is filtered from the airstream, before passing through a carbon filter set to reduce odours. Filtered air is then reintroduced into the kitchen.

Constructed using durable stainless steel, Refresh units come with a pre-programmed fan control system, filter life monitoring and cook-line equipment interlock interface. The unit is manufactured to the ISO 9001-2015 quality standard.

Ideally suited for...

Struggling with venting to the atmosphere? Solve the problem with Refresh ventilation and recirculation units. They are ideal for a wide range of locations, including:



Restricted buildings

From high-rise buildings to basements, and properties with listed status and planning restrictions, Refresh is the ideal solution. Where venting to the atmosphere is impossible, difficult or costly, it provides a safer, more comfortable working environment.



Concession areas

Concession areas in airports and transport concourses can be difficult locations to vent to the atmosphere. Refresh units require no venting and filter air, providing a better kitchen space for staff



Pubs, snack bars and coffee shops

Ventless cooking is ideal for smaller pubs, snack bars and coffee shops, where ventilation to the atmosphere is difficult or costly. Refresh units are quick and easy to install, and provide a safer, more comfortable working space.

Make your kitchen safer, cleaner and more comfortable with a Refresh ventilation unit.

Benefits at a glance

- No venting required
- For use with electrical appliances
- Accommodate multiple pieces of equipment
- Quick and easy to install
- Multi-stage filtration
- Filter monitor and fan control systems
- Manufactured to ISO 9001-2015
- Durable construction
- Cook-line can be interlocked to the unit

Refresh Recirculation Units

- Highly efficient four stage sequential filtration process removes grease, fine particulate, smoke and odour
- Ideal for use where venting to the atmosphere is impractical
- Suitable for use with electric cooking equipment only
- Free standing in design, their flexibility can increase output in existing kitchens or allow the set up of a cooking station in previously unsuitable areas of a building



Refresh Mini Recirculation Unit										
MODEL	PRICE £	PRICE €	DESCRIPTION	COOKLINE LENGTH	H	W	D	POWER	WT	
* Y10030	£8708	€10,015	Refresh Mini	500	2222	555	734	190W	131	

MODEL	PRICE £	PRICE €	DESCRIPTION
S SE100/109	£92.85	€106.80	Baffle filter
S SE100/103	£96.90	€111.45	Carbon filter
S SE100/100	£25.50	€29.35	G4 filter set
S SE100/106	£413.10	€475.10	HEPA filter

Refresh Midi Recirculation Unit										
MODEL	PRICE £	PRICE €	DESCRIPTION	COOKLINE LENGTH	H	W	D	POWER	WT	
* Y10020	£11,204	€12,885	Refresh Midi	1000	2222	1050	734	190W	183.5	

MODEL	PRICE £	PRICE €	DESCRIPTION
S SE100/110	£181.60	€208.85	Baffle filter
S SE100/104	£190.75	€219.40	Carbon filter
S SE100/101	£46.95	€54	G4 filter set
S SE100/107	£823.15	€946.65	HEPA filter

Refresh Maxi Recirculation Unit										
MODEL	PRICE £	PRICE €	DESCRIPTION	COOKLINE LENGTH	H	W	D	POWER	WT	
* Y10010	£15,887	€18,259	Refresh Maxi	1500	2222	1551	734	380W	246	

MODEL	PRICE £	PRICE €	DESCRIPTION
S SE100/111	£268.30	€308.55	Baffle filter
S SE100/105	£283.60	€326.15	Carbon filter
S SE100/102	£70.40	€81	G4 filter set
S SE100/108	£1231.15	€1415.85	HEPA filter

Please note: Range ovens and fryers are for illustrative purposes and not included

* Please refer to page B7 for electricity supply requirements

Electricity Supply Requirements

Electrical products not listed on this page are supplied for operation on a 230/240v, 13 amp supply.

Brand	Product Code	Power Supply/ Connection Type	Electrical Supply Rating [watts]	Single Phase		Three Phase			
				Amps	Voltage	Amps - Phase 1	Amps - Phase 2	Amps - Phase 3	Voltage
Britannia	Y10010	16A Commando Plug	3,500	1.65	220	-	-	-	-
Britannia	Y10020	16A Commando Plug	3,500	0.68	220	-	-	-	-
Britannia	Y10030	16A Commando Plug	3,500	0.68	220	-	-	-	-

Sale Terms & Conditions

Standard Terms & Conditions of Sale

1. DEFINITIONS and GENERAL

1. The Company – Lincat Limited, Whisby Road, Lincoln LN6 3QZ
2. The Buyer – the person, firm or company contracting with the Company.
3. The Contract – any contract between the Company and the Buyer for the sale and purchase of goods upon these terms and conditions.
4. All orders are accepted subject to these Conditions of Sale which shall apply to the exclusion of any terms or conditions put forward by or on behalf of the Buyer.
5. No variation, waiver or addition to these conditions, whether written or oral, shall have effect unless agreed in writing by the Company.

2. DESCRIPTION

1. Although every effort has been made to ensure that the illustration, price, description, measurement and specification of goods in our catalogues, brochures and on the website are correct such information is published for the sole purpose of giving an approximate idea of the goods represented by or described in them. They will not form part of the Contract and this is not a sale by sample. Where any such details are important the Buyer should themselves verify the information before placing an order.
2. The Company reserves the right to modify or vary the design, specification or finish of any of our products without notice.

3. ORDERS

1. The Buyer shall be responsible to the Company for ensuring the accuracy of any order.
2. No order which has been accepted by the Company may be cancelled except on terms that the Buyer shall indemnify the Company against all loss (including loss of profit), costs (including the cost of all material and labour used) damages, charges and expenses incurred by the Company as a result of cancellation.
3. The Buyer is responsible for controlling its users' access to place orders on www.lincat.co.uk and revoking such access when necessary. By allowing a user access to the website the customer is responsible for orders placed.
4. Order acknowledgements will be sent to the email address nominated by the Buyer. The Buyer is responsible for ensuring that the correct email address is provided and maintained.

4. PRICE OF GOODS

1. The price of the goods shall be the price listed in the Company's published price list current at the date of despatch of the order less agreed discount.
2. The price of the goods is exclusive of Value Added Tax, which will be charged at the applicable rate at the date of invoice.
3. The price of the goods includes the cost of carriage by the Company's standard three day service to mainland England, Scotland (excluding Highlands) and Wales. Deliveries to other destinations will be charged separately where the Company undertakes delivery of the goods.
4. In the event of any increase in the cost to the Company of supplying the goods caused by any reason whatsoever the Company may on giving notice to the Buyer at any time before delivery adjust the price.
5. In the event that the price of goods is incorrectly displayed on the website, the Company shall not be obliged to honour this.

5. TERMS OF PAYMENT

1. The Buyer shall pay the price of the Goods without any deduction within 30 days of the end of the month in which the goods are invoiced. Time for payment will be of the essence. No payment will be deemed to have been received until the Company has received clear funds. All sums payable under the Contract will become due immediately upon termination of the Contract. The Company reserves the right to claim settlement of any outstanding amounts due before this date if there is any change in the financial circumstances of the Buyer.
2. In the event that any payment due to the Company is withheld or delayed the Company reserves the right:
 1. to suspend any further deliveries to the Buyer
 2. charge interest at 2.5% pa above the base lending rate from time to time of the Royal Bank of Scotland Plc on the amount outstanding from the date when payment becomes due until the date of payment
 3. to recover from the Buyer on a full indemnity basis together with interest thereon all costs incurred by it in obtaining payment including solicitor's fees and costs associated with so doing.

6. DELIVERY

1. The Company will use reasonable endeavours to deliver the goods within the time agreed when the Buyer places an order and, if no time is agreed, then within a reasonable time, but the time of delivery will not be of the essence. If, despite those endeavours, the Company is unable for any reason to fulfil any delivery or performance on the specified date, the Company will be deemed not to be in breach of the Contract, nor (for the avoidance of doubt) will the Company have any liability to the Buyer for direct, indirect or consequential loss (all three of which terms includes, without limitation, pure economic loss, loss of profits, loss of business, depletion of goodwill and like loss) howsoever caused (including as a result of negligence) by any delay or failure in delivery except as set out in this condition.
2. Any costs incurred due to inadequate site access shall be charged to the Buyer.
3. If the Buyer fails to take delivery of the goods the Company shall be entitled to invoice and be paid for the goods as though they had been duly delivered. The Company may arrange storage of the goods until actual delivery and charge the Buyer for the reasonable costs of storage.
4. It is the Buyer's responsibility to inspect the goods at the time of delivery. The Company accepts no responsibility for alleged non-delivery, shortfall of goods,

damage on delivery or other discrepancy unless notification in writing is received within 24 hours from the date of delivery. In the absence of such notification the Buyer shall be deemed to have accepted the goods.

7. RETURNS

1. Goods despatched to the Buyer and subsequently accepted for cancellation by the Company will be subject to an abortive delivery charge, as well as any cancellation charge deemed necessary by the Company.
2. The Company at its absolute discretion may agree to the return of goods by the Buyer within 28 days of delivery, provided that the goods are returned at the Buyer's expense, in the same condition and in the original packaging.
3. Any goods agreed by the Company as acceptable for return for any reason (excluding faulty goods) will be subject to a restocking charge of 25% of the net invoiced price, together with the reimbursement of any expense incurred by the Company as a consequence of the return of said goods to the Company's stock.

8. RISK AND PROPERTY

1. Risk of damage to or loss of the goods shall pass to the Buyer at the time of delivery or, if the Buyer wrongfully fails to take delivery of the goods, the time when the Company has tendered delivery of the goods.
2. Notwithstanding delivery and the passing of risk in the goods the property in the goods shall not pass to the Buyer until the full price of the goods and goods which are subject to any other contract between the Buyer and the Company is received in full in cash or cleared funds.
3. Until such time as the property in the goods passes to the Buyer they shall be held by the Buyer in a fiduciary capacity and stored by the Buyer at its premises in such a manner that they are clearly identifiable as the goods of the Company and shall be kept separate from any other goods whether or not supplied by the Company. Until that time the Buyer shall be entitled to sell the goods in the ordinary course of its business but shall account to the Company for the proceeds of sale.
4. Until such time as the property in the goods passes to the Buyer the Company shall be entitled at any time to require the Buyer to deliver up the goods to the Company and if the Buyer fails to do so forthwith to enter upon any premises of the Buyer or any third party where the goods are stored and repossess the goods. The Buyer hereby grants an irrevocable licence to the Company for this purpose.

9. WARRANTY, EXCLUSION OF LIABILITY AND INDEMNITY

1. Warranty
 1. In respect of goods (excluding spare parts and consumable items such as door seals, filters, bulbs, glass and LTX toaster elements) which are proved to the reasonable satisfaction of the Company to be damaged or defective due to defects in material or workmanship, the Company will, free of charge, within a period of 24 months (12 months for IMC Mobile Hand Wash Stations and Sanitising Stations) from the date of resale of such goods by The Buyer, either (at the Company's option):
 1. repair such goods; or
 2. replace such goods; or
 3. refund the purchase price of the goods.
 2. The obligation in condition 9.1.1 above will not apply where:
 1. the goods have been improperly altered in any way whatsoever, or have been subject to misuse or unauthorised repair;
 2. the goods have been improperly installed or connected;
 3. any maintenance requirements relating to the goods have not been complied with.
 4. the goods are gas powered and have been installed into a mobile catering outlet such as, but not limited to, a catering trailer, in which case the Company's obligation is limited to the free-of-charge supply of spare parts.
 3. Any goods which have been replaced will belong to the Company. Any repaired or replacement goods will be liable to repair, replacement or refund under the terms specified in condition 9.1.1 for the unexpired portion of the 24 month period from the original date of resale of the repaired or replaced goods.
2. Exclusion of liability
 1. In the event of any breach of the Company's express obligations under Conditions 6.1, 9.1.1 and 9.1.3 above the remedies of the Buyer will be limited to damages.
 2. The Company does not exclude its liability (if any) to the Buyer:
 1. for breach of the Company's obligations arising under section 12 Sale of Goods Act 1979 or section 2 Sale and Supply of Goods and Services Act 1982
 2. for personal injury or death resulting from the Company's negligence
 3. under section 2(3) Consumer Protection Act 1987
 4. for any matter which it would be illegal for the Company to exclude (or to attempt to exclude) its liability, or
 5. for fraud.
 3. Except as provided in Conditions 6.1 and 9.1.1 to 9.2.2 the Company will be under no liability to the Buyer whatsoever (whether in contract, tort (including negligence), breach of statutory duty, restitution or otherwise) for any injury, death, damage or direct, indirect or consequential loss (all three of which terms include, without limitation, pure economic loss, loss of profits, loss of business, depletion of goodwill and like loss) howsoever caused arising out of or in connection with:
 1. any of the goods, or the manufacture or sale or supply, or failure or delay in supply, of the goods by the Company or on the part of the Company's employees, agents or sub-contractors
 2. any breach by the Company of any of the express or implied terms of the Contract
 3. any use made or resale by the Buyer of any of the goods, or of any product incorporating any of the goods; or

4. any statement made or not made, or advice given or not given, by or on behalf of the Company
5. or otherwise under the Contract
4. Except as set out in conditions 6.1 and 9.1.1 to 9.2.2 the Company hereby excludes to the fullest extent permissible in law, all conditions, warranties and stipulations, express (other than those set out in the Contract) or implied, statutory, customary or otherwise which, but for such exclusion, would or might subsist in favour of the Buyer.
5. Each of the Company's employees, agents and sub-contractors may rely upon and enforce the exclusions and restrictions of liability in conditions 6.1 and 9.2.1 to 9.2.3 in that person's own name and for that person's own benefit, as if the words "its employees, agents and sub contractors" followed the word Company wherever it appears in those conditions save each reference in condition 9.2.3.1
6. The Buyer acknowledges that the above provisions of this Condition 9 are reasonable and reflected in the price which would be higher without those provisions, and the Buyer will accept such risk and/or insure accordingly.
7. Subject to condition 9.2.2 the Company's aggregate liability under the Contract whatsoever (whether in contract, tort (including negligence), breach of statutory duty, restitution or otherwise) and howsoever arising to the Buyer will be limited to the price of the goods.

10. FORCE MAJEURE

1. The Company shall not be liable in respect of any breach of contract due to any cause beyond its reasonable control including Act of God, inclement weather, flood, lightning or fire, industrial action or lockouts, actions of government departments, war, riot or terrorism, or the action of any party for whom the Company is not directly responsible.

11. SEVERABILITY

1. If any condition or part of the Contract is found by any court, tribunal, administrative body or authority of competent jurisdiction to be illegal, invalid or unenforceable then that provision will, to the extent required, be severed from the Contract and will be ineffective without, as far as is possible, modifying any other provision or part of the Contract and this will not affect any other provisions of the Contract which will remain in full force and effect.

12. ENTIRE AGREEMENT

1. The Contract contains all the terms which the Company and the Buyer have agreed in relation to the goods and supersedes any prior written or oral agreements, representations or understandings between the parties relating to such goods. The Buyer acknowledges that it has not relied on any statement, promise or representation made or given by or on behalf of the Company which is not set out in the Contract.

13. LAW AND JURISDICTION

1. The Contract shall be governed and construed in all respects in accordance with the Laws of England and shall be subject only to the jurisdiction of the English Courts.

Clarified warranty conditions

1. General

Installation – Equipment should be installed by a qualified person and located as per the instructions. Supplied services (Gas, Electricity and Water) should meet the specification supplied with the equipment and conform to current regulations. Gas pressure must meet the specification in the installation manual.

Maintenance – Users are required to regularly clean equipment and ensure servicing is carried out when required. Gas equipment should be serviced at least annually.

Modifications – any modification to the equipment will invalidate the warranty.

User damage – any damage to the equipment that affects its usage will invalidate the warranty. This includes use of incorrect cleaning agents.

2. Access

Service engineer visits are made between 8:30 a.m. and 5:00 p.m. on weekdays. It is the customer's responsibility to ensure that the service engineer can access the equipment to effect repairs. Waiting time and abortive calls will be charged to the customer.

3. General exclusions

Gas

Gas products are supplied for either LPG or Natural Gas use and must be connected to the correct gas. All installations must conform to current gas regulations. Gas supplies must attain the minimum pressure levels as indicated in the instructions at all times. If a regulator is supplied with the unit then it must have been fitted correctly and set to the required pressure.

Electric (excluding equipment supplied with BS 1363 plugs)

All products must be connected to supplies with the correct voltage and phasing by a qualified electrician and comply with current regulations.

Water – all except filter flow

Any issue identified as a result of the water supply, e.g. water pressure or water hardness is not covered by the warranty. De-scaling is chargeable to the customer. Filter systems must be capable of maintaining correct levels of treated water, and users must ensure filters are changed regularly.

Specific general exclusions

- Damage to control knobs and buttons due to misuse.
- Discolouration of components due to heat.
- Resolving drainage problems where drainage does not meet requirements.
- Lubrication of moving parts.
- Corrosion caused by the use of chemical cleaners.
- Replacement of components due to internal contamination as a result of spillage or accumulation of grease/food debris due to a lack of cleaning.
- Cabinet, drawer and door seals are considered consumable items and will not be replaced under warranty.
- Light bulbs and lens covers are considered consumable items and will not be replaced under warranty.
- Enamel coated components if impacted sufficiently will crack or chip, such damage is not covered by the terms of this warranty.
- Rectification where non-Lincat specified parts have been used.
- Where user error is established.

4. Additional exclusions by type

Gas general

- Poor combustion caused by lack of cleaning.
- Failure of components directly linked to poor cleaning and/or maintenance.
- Cleaning of burners jets.
- Cleaning/adjustment of pilots and thermocouples.
- Correction of gas pressure to the appliance.
- Lubrication of gas valves.
- Renewing of gas supply fittings external to the appliance.

Electrical general

- Resetting of safety devices including fuses where no other fault exists.
- Renewing of supply cable ends.

Filter Flow

- Failure to replace the filter with a Lincat supplied item.
- Descaling of the unit.
- Damage to the elements resulting from mechanical descaling e.g. using a scraper.

Fryers

- Cleaning and un-blocking of fryer filter systems due to customer misuse.
- Replacement of components damaged by cooking oils due to a lack of cleaning and care when replacing oil.
- Damage to thermostats.

Steamers

- Damage resulting from lack of water flow to the unit.

Induction

- Chipped or damaged glass not reported at time of delivery.
- Damage due to blocked or missing air filters.

Chargrills and salamanders with Ceramic burners

- Impact damage caused by the user.

Chargrill Radiant covers

- Radiant covers are considered consumable items and may corrode if not regularly cleaned due to prolonged contact with salt and fats and will not be replaced under warranty.
- Damage to heaters due to failure to replace radiant covers is not covered by the warranty.

Heated and chilled food displays

- Chipped or damaged glass not reported at time of delivery.
- Damage to components resulting from restricted airflow to inlets and outlet.
- Damage to components resulting from accumulation of airborne particles.
- Condensation on cold surfaces if units are installed in environments beyond specification.

5. Replacement units additional conditions

Lincat may choose to replace a unit that requires repair.

Lincat reserve the right to send an engineer to attempt a repair before a replacement is offered.

If no fault is found Lincat reserves the right to charge for the replacement. Acceptance of delivery of a new unit is acceptance of this condition by the customer.

Any goods which have been replaced will belong to the Company. Any repaired or replacement goods will be covered for the unexpired portion of the original warranty.

Lined paper area with horizontal ruling lines for writing.

The Lincat Edge

Here at Lincat we have values which run through our company and that are incredibly important to all of us. These values are reflected in the decisions that we make and guide everything that we do.

01. We're focused on you

- Our passion is delivering what our customers want and need in order for them create fabulous food and to succeed.

05. We're never satisfied

- We always strive to do things better. We know we're not perfect, but we work with the mantra of learning and improving every day. We don't take your business for granted.

02. We're driven by delivering quality

- At Lincat our focus is on delivering only the best quality products. It's a mantra that goes into all of the work that we do at our state of the art manufacturing facility in our home town of Lincoln.

06. We're innovative

- 10% of our employees - from chefs to engineers - are focused on creating innovative equipment to make your life easier.

03. We're foodies at heart

- Food is a passion for us. That's why we strive to provide the very best equipment for you to achieve excellent results and deliver delicious dishes time after time.

06. We find solutions

- Whether you bake, grill, boil or fry on a small scale for a cafe, or cook on a huge scale at a hospital, we're confident that we can find a solution for you.

04. We're reliable

- We're extremely confident in the quality and durability of our products. They won't let you down and neither will we.

08. We're agile

- We're flexible and can move quickly to help you. If you need something, we will find a way to help.

PRODUCT CODES: /N = natural gas /P = propane gas Btu/hr = kW x 3412



Gas



Electric



Accessories



Spare Parts



Factory Fit Options



Consumables



Lincat **imc** **frifri** **Britannia**
fresh thinking kitchen ventilation

Lincat Limited, Whisby Road, Lincoln. LN6 3QZ. United Kingdom.

☎ UK Tel: 01522 875500 ☎ Export Tel: +44 1522 503250 ✉ UK e-mail: sales@lincat.co.uk ✉ Export e-mail: export@lincat.co.uk

Group member of  MIDDLEBY